



Allen-Bradley

MicroLogix™ Ethernet Interface

**1761-NET-ENI and
1761-NET-ENIW**

User Manual

**Rockwell
Automation**

Important User Information

Solid state equipment has operational characteristics differing from those of electromechanical equipment. *Safety Guidelines for the Application, Installation and Maintenance of Solid State Controls* (Publication SGI-1.1 available from your local Rockwell Automation sales office or online at <http://www.ab.com/manuals/gi>) describes some important differences between solid state equipment and hard-wired electromechanical devices. Because of this difference, and also because of the wide variety of uses for solid state equipment, all persons responsible for applying this equipment must satisfy themselves that each intended application of this equipment is acceptable.

In no event will Rockwell Automation, Inc. be responsible or liable for indirect or consequential damages resulting from the use or application of this equipment.

The examples and diagrams in this manual are included solely for illustrative purposes. Because of the many variables and requirements associated with any particular installation, Rockwell Automation, Inc. cannot assume responsibility or liability for actual use based on the examples and diagrams.

No patent liability is assumed by Rockwell Automation, Inc. with respect to use of information, circuits, equipment, or software described in this manual.

Reproduction of the contents of this manual, in whole or in part, without written permission of Rockwell Automation, Inc. is prohibited.

Throughout this manual we use notes to make you aware of safety considerations.

WARNING

Identifies information about practices or circumstances that can cause an explosion in a hazardous environment, which may lead to personal injury or death, property damage, or economic loss.

IMPORTANT

Identifies information that is critical for successful application and understanding of the product.

ATTENTION

Identifies information about practices or circumstances that can lead to personal injury or death, property damage, or economic loss. Attentions help you:

- identify a hazard
 - avoid a hazard
 - recognize the consequence
-

SHOCK HAZARD

Labels may be located on or inside the drive to alert people that dangerous voltage may be present.

BURN HAZARD

Labels may be located on or inside the drive to alert people that surfaces may be dangerous temperatures.

Summary of Changes

The information below summarizes the changes to this manual since the last printing.

To help you find new and updated information in this release of the manual, we have included change bars as shown to the right of this paragraph.

Information on 1761-NET-ENI and 1761-NET-ENIW, series D, has been added throughout the manual. The table below lists the sections that document new features and additional or updated information on existing features.

For this information:	See
how to obtain a manual from Rockwell Automation	P-2
Series D LED description	page 1-3
Ethernet Settings	page 1-6
Series D Enhancements	page 1-8
Using the RSLinx Ethernet/IP driver with series B ENIs and higher	page 3-5
Download location for ENI/ENIW Configuration Utility	page 4-1
Download location for Com Port Redirector software	page 4-1
Updated examples and information on making configuration settings using the ENI/ENIW Configuration Utility, including series D configuration options	pages 4-2 to 4-4
Series D Email Authentication	pages 4-5 and 6-2
Updated information on using the ENI/ENIW Configuration Utility over RS-232	page 4-6
New information on using the ENI/ENIW Configuration Utility over Ethernet (series D only), including using the Com Port Redirector software	pages 4-8
Updated information on configuration node functions	page 4-12
Configuring Email Authentication options for series D ENI/ENIW	pages 4-20 to 4-21
Configuring Ethernet speed and duplex settings for series D ENI/ENIW	page 4-22
Series D Web Page Enhancements	chapter 7
LED sequence at power-up for series A/B/C/D	page 9-2
Troubleshooting using the LED indicators series A/B/C/D	page 9-3
Series C and D Ethernet specifications	page A-1
Updated information on configuration via BOOTP	Appendix B
1761-NET-ENI/ENIW performance considerations	Appendix C

Preface

Who Should Use this Manual	P-1
Purpose of this Manual	P-1
Related Documentation	P-2
Common Techniques Used in this Manual	P-2
Your Questions or Comments on this Manual	P-3

Product Overview

Chapter 1

EtherNet/IP Connectivity	1-1
Hardware Features	1-2
Product Drawing	1-2
LED Indicators	1-2
Default Settings	1-5
Operating Modes	1-7
Messaging	1-7
Email	1-7
Device Compatibility	1-7
Series B Enhancements	1-7
Series C Enhancements	1-8
Series D Enhancements	1-8
Ethernet Networks	1-8
Basic Ethernet Topology	1-8
Web Server Functionality	1-9

Installation and Wiring

Chapter 2

European Communities (EC) Directive Compliance	2-1
EMC Directive	2-1
Low Voltage Directive	2-1
Safety Considerations	2-2
External Power Supply Wiring	2-3
Mounting	2-3
DIN Rail Mounting	2-4
Panel Mounting	2-4
ENI/ENIW Port Identification	2-5
Ethernet Connections	2-5
Ethernet 8-Pin 10/100-Base-T Connector (Port 1)	2-5
Ethernet Cables	2-6
Maintain ENI and ENIW Cable Connections	2-6
RS-232 Port Connections	2-7
RS-232 Connector	2-7
RS-232 Cables	2-7

Operation	<p>Chapter 3</p> <p>Operation Overview 3-1</p> <p>Allocation of Ethernet Connections 3-1</p> <p>ENI and ENIW Functional Overview 3-2</p> <p>General Ethernet Information 3-2</p> <p>RSLinx/RWho Connectivity Example Using ENI/ENIW Interface 3-2</p> <p style="padding-left: 20px;">PC Connected Directly to Ethernet (RSLinx on Ethernet) 3-4</p> <p style="padding-left: 20px;">PC Connected to Ethernet via the ENI or ENIW 3-8</p>
ENI/ENIW Configuration (Nodes 241 to 254)	<p>Chapter 4</p> <p>Configuration Methods 4-1</p> <p>ENI/ENIW Configuration Utility 4-1</p> <p style="padding-left: 20px;">Make Configuration Settings 4-2</p> <p style="padding-left: 20px;">Save to ENI/ENIW RAM or ENI/ENIW ROM 4-4</p> <p style="padding-left: 20px;">Email Settings 4-5</p> <p style="padding-left: 20px;">Message Routing 4-5</p> <p style="padding-left: 20px;">Reset 4-6</p> <p style="padding-left: 20px;">Use the Configuration Utility Over RS-232 4-6</p> <p style="padding-left: 20px;">Use the Configuration Utility Over Ethernet (Series D only) 4-8</p> <p>Controller Messaging 4-12</p> <p>ENI/ENIW Configuration Parameters 4-12</p> <p style="padding-left: 20px;">Node 254 - Ethernet Hardware Address 4-13</p> <p style="padding-left: 20px;">Node 253 - Baud Rate 4-14</p> <p style="padding-left: 20px;">Node 252 - BOOTP Configuration 4-15</p> <p style="padding-left: 20px;">Node 251 - Email Server 4-15</p> <p style="padding-left: 20px;">Node 250 - TCP/IP Configuration 4-15</p> <p style="padding-left: 20px;">Node 249 - From String 4-19</p> <p style="padding-left: 20px;">Node 248 - Save/Reset Function 4-19</p> <p style="padding-left: 20px;">Node 245 - Configuration Security Mask 4-20</p> <p style="padding-left: 20px;">Node 244 - SMTP Email Authentication Checkbox (Series D Only) 4-20</p> <p style="padding-left: 20px;">Node 243 - SMTP Email Authentication Password (Series D Only) 4-21</p> <p style="padding-left: 20px;">Node 242 - SMTP Email Authentication Username (Series D Only) 4-21</p> <p style="padding-left: 20px;">Node 241 - Ethernet Speed and Duplex Setting (Series D Only) 4-22</p> <p>Configuring ENI/ENIW Data Parameters 4-22</p> <p>Configuring ENI/ENIW String Parameters 4-24</p> <p style="padding-left: 20px;">Configuring the ENI/ENIW Email From String 4-24</p>

	Chapter 5	
Peer-to-Peer Messaging	Messaging Between the ENI/ENIW and DF1 Devices	5-1
	Message to Configuration Nodes (Nodes 100 to 149) and Sending a Message to a Destination Controller (Nodes 0 to 49)	5-2
	Chapter 6	
E-Mail Messages (Node 50 to 99)	Overview	6-1
	Configuring Email	6-2
	SMTP Email Address	6-2
	Destination Addresses	6-3
	Message Text	6-3
	Message Fields (to, from, subject)	6-4
	Sending an Email Message	6-4
	Chapter 7	
1761-NET-ENIW Web Server Capabilities	Web Browser Compatibility	7-1
	Series D ENIW Web Pages	7-1
	Home Page	7-2
	Defining URL Links	7-3
	Displaying Device Data	7-5
	String Data	7-5
	Integer Data	7-6
	Floating-point Data	7-7
	Writing Data to the ENIW	7-8
	Auto-Refresh of Data View Pages	7-9
	ENIW Update Timer	7-9
	Posting Data to the Device	7-10
	Setting Passwords for Data View Pages	7-10
	Posting Data	7-10
	Display Event Data	7-11
	Display Diagnostic Data	7-12
	Display Configuration	7-13
	Use the ENIW Utility to Configure the ENIW's Web Server Functionality	7-14
	Configure the Home Page	7-14
	Configure Data View Pages	7-14
	Chapter 8	
Connecting CompactLogix Controllers on Ethernet	System Diagram	8-2
	Purpose	8-3
	Scope	8-3
	General CompactLogix Messaging Guidelines	8-4
	Configure ENI #1	8-5
	Configure ENI #2	8-7
	Configure ENI #2 Via the ENI/ENIW Configuration Utility	8-8

	Configuration Via Ladder Logic.	8-10
	Download To The CompactLogix Controller Through Two Series A ENIs	8-17
	Download to the CompactLogix Controller Through a ENI/ENIW Series B/C/D via Ethernet	8-19
	Create MSG Programs for the SLC 5/05 and the ControlLogix Controllers	8-21
	Chapter 9	
Troubleshooting	Network Troubleshooting	9-1
	Maintain ENI/ENIW Cable Connections.	9-1
	Using ENI/ENIW with Routers	9-1
	LED Sequence at Power-Up.	9-2
	Troubleshooting Using the LED Indicators	9-3
	Error Codes Generated by the ENI/ENIW.	9-6
	Appendix A	
Specifications	Physical Specifications.	A-1
	Series C and D Ethernet Specifications	A-1
	MicroLogix Web Site	A-1
	Dimensions.	A-2
	Appendix B	
BOOTP Configuration Method (default)	ENI/ENIW BOOTP Operation	B-2
	Using the Rockwell BOOTP/DHCP Utility	B-3
	Appendix C	
1761-NET-ENI/ENIW Performance Considerations	Ethernet/IP Connections	C-1
	Packet Size Limitations.	C-1
	Data Throughput	C-2
	Glossary	
	Index	

Read this preface to familiarize yourself with the rest of the manual. It provides information concerning:

- who should use this manual
- the purpose of this manual
- related documentation
- conventions used in this manual
- Rockwell Automation support

Who Should Use this Manual

Use this manual if you are responsible for designing, installing, programming, or troubleshooting control systems that use Allen-Bradley Controllers on Ethernet.

You should have a basic understanding of Allen-Bradley programmable controllers and Ethernet networking. You should understand programmable controllers and be able to interpret the ladder logic instructions required to control your application. If you do not, contact your local Allen-Bradley representative for information on available training courses before using this product.

Purpose of this Manual

This manual is a reference guide for the Ethernet Interface (ENI) and Web-enabled Ethernet Interface (ENIW). It describes the procedures you use to install and configure the ENI and ENIW.

Related Documentation

The following documents contain additional information concerning Rockwell Automation products. To obtain a copy, contact your local Rockwell Automation office or distributor.

For	Read this Document	Document Number
Instructions on installing a 1761-NET-ENI or 1761-NET-ENIW Interface Converter.	Ethernet Interface Installation Instructions	1761-IN007
Information on DF1 open protocol.	DF1 Protocol and Command Set Reference Manual	1770-6.5.16
In-depth information on designing, implementing, and maintaining an industrial control system using EtherNet/IP (Ethernet Industrial Protocol)	EtherNet/IP Media Planning and Installation Manual	ENET-IN001
In-depth information on grounding and wiring Allen-Bradley programmable controllers	Allen-Bradley Programmable Controller Grounding and Wiring Guidelines	1770-4.1
A description of important differences between solid-state programmable controller products and hard-wired electromechanical devices	Application Considerations for Solid-State Controls	SGI-1.1
An article on wire sizes and types for grounding electrical equipment	National Electrical Code - Published by the National Fire Protection Association of Boston, MA.	
A glossary of industrial automation terms and abbreviations	Allen-Bradley Industrial Automation Glossary	AG-7.1

If you would like a manual, you can:

- download a free electronic version from the internet at **www.rockwellautomation.com/literature**.
- purchase a printed manual by contacting your local Allen-Bradley distributor or Rockwell Automation sales office.

Common Techniques Used in this Manual

The following conventions are used throughout this manual:

- Bulleted lists such as this one provide information, not procedural steps.
- Numbered lists provide sequential steps or hierarchical information.
- *Italic* type is used for emphasis.
- ENI/ENIW is used when information and instructions are applicable to both the 1761-NET-ENI and 1761-NET-ENIW. In cases where information applies to only one type of interface, the appropriate model and series is identified.

Your Questions or Comments on this Manual

If you find a problem with this manual, or you have any suggestions for how this manual could be made more useful to you, please contact us at the address below:

Rockwell Automation
Automation Control and Information Group
Technical Communication, Dept. A602V
P.O. Box 2086
Milwaukee, WI 53201-2086

or visit our internet page at:

<http://www.rockwellautomation.com>

Product Overview

This chapter gives an overview of the Ethernet Network Interface. The following topics are covered:

- EtherNet/IP Connectivity
- Hardware Features
- Operating Modes
- Device Compatibility
- Enhancements by Series
- Ethernet Networks
- Web-Server Functionality

EtherNet/IP Connectivity

The 1761-NET-ENI and 1761-NET-ENIW provide EtherNet/IP connectivity for all MicroLogix controllers, CompactLogix controllers, and other DF1 full-duplex devices. The Ethernet Network Interface, ENI or ENIW, allows you to easily connect non-Ethernet controllers onto new or existing Ethernet networks and upload/download programs, communicate between controllers, and generate email messages via SMTP (simple mail transport protocol).

EtherNet/IP is an industry standard open protocol which provides inter-device compatibility. You can exchange information with other Allen-Bradley Ethernet controllers (SLC, PLC, and ControlLogix) in a peer-to-peer relationship, so you do not need any master-type device.

The ENI and ENIW also support an SMTP mail service that allows an existing controller to send email messages to any destination connected to the network. The email can be used to initiate the transmission of data or status information.

Hardware Features

Product Drawing

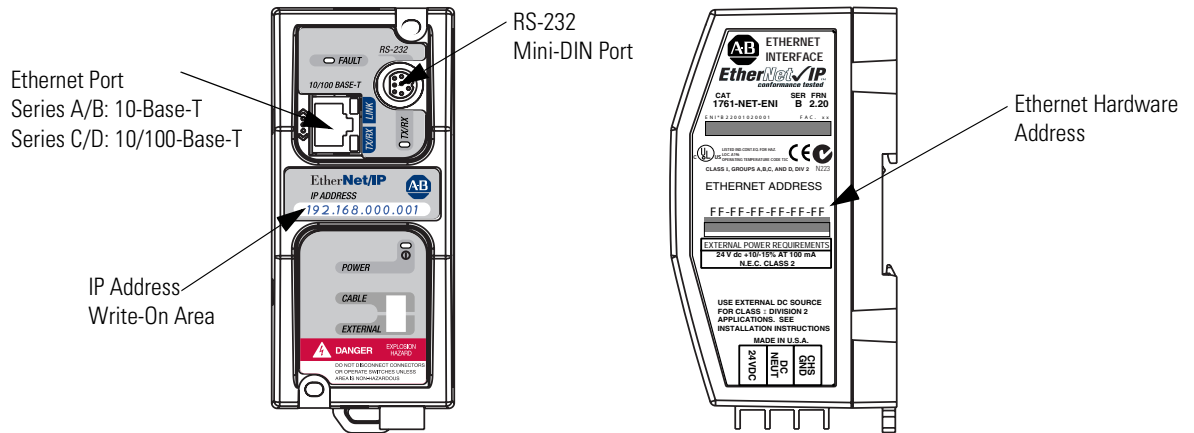

LED Indicators

The ENI and ENIW have five LED indicators:

Table 1.1 Series A/B Descriptions

LED	Description	Function	Color
RS-232 TX/RX	RS-232 data transmission indicator	flashes when the RS-232 port is transmitting or receiving data	green
POWER	module power	lit when module is powered	green
LINK	Ethernet link status	lit when there is a valid physical Ethernet connection	green
Ethernet TX/RX	Ethernet data transmission indicator	flashes when the Ethernet port is transmitting or receiving data indicates Ethernet network traffic to and from the ENI/ENIW	green
FAULT	fault condition indicator	lit when a fault condition is present	red or flashing red

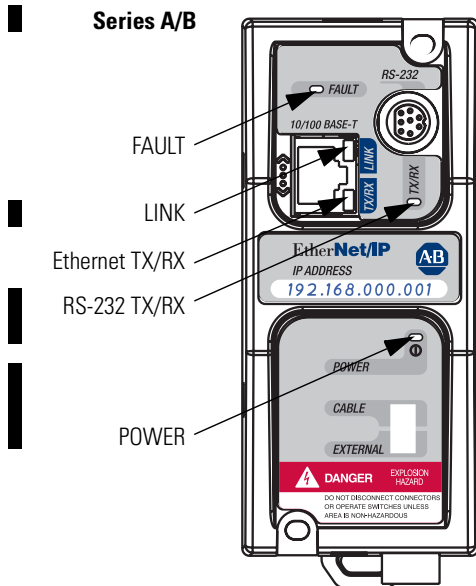

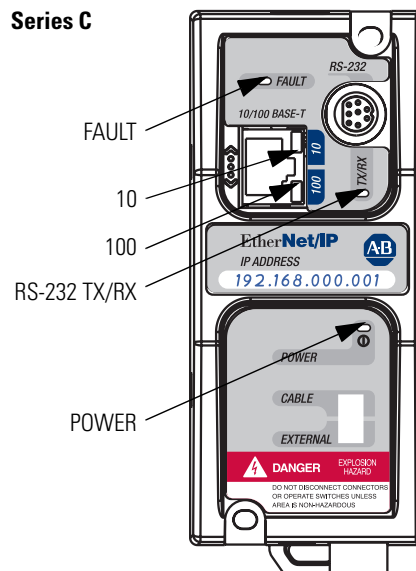

Table 1.2 Series C Descriptions

LED	Description	Function	Color
RS-232 TX/RX	RS-232 data transmission indicator	RS-232 port is transmitting or receiving data	flashing green
		no RS-232 traffic	off
POWER	module power	module is powered	green
10	10-Base-T Ethernet link status and data transmission indicator	No link or continuous data activity	off
		10-Base-T Half Duplex; Link good however no data activity	amber
		10-Base-T Half Duplex; Link good with sporadic data activity ⁽¹⁾	flashing amber
		10-Base-T Full Duplex; Link good however no data activity	green
		10-Base-T Full Duplex; Link good with sporadic data activity ⁽¹⁾	flashing green
100	100-Base-T Ethernet link status and data transmission indicator	No link or continuous data activity	off
		100-Base-T Half duplex; Link good however no data activity	amber
		100-Base-T Half Duplex; Link good with sporadic data activity ⁽¹⁾	flashing amber
		100-Base-T Full Duplex; Link good however no data activity	green
		100-Base-T Full Duplex; Link good with sporadic data activity ⁽¹⁾	flashing green
FAULT	fault condition indicator	lit when a fault condition is present	red or flashing red

(1) Any Ethernet network activity; not necessarily to or from the ENI/ENIW.

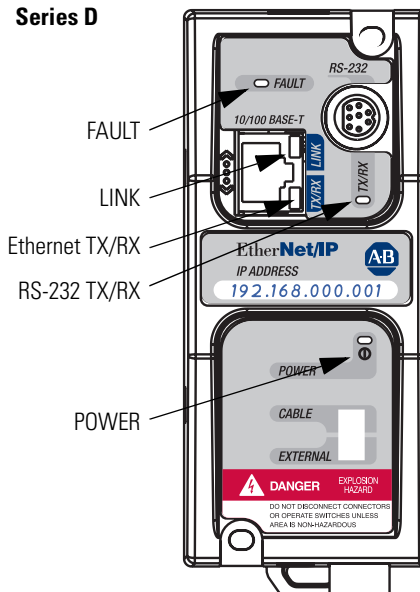

Table 1.3 Series D Descriptions

LED	Description	Function	Color
RS-232 TX/RX	RS-232 data transmission indicator	RS-232 port is transmitting or receiving data	flashing green
		no RS-232 traffic	off
POWER	module power	module is powered	green
LINK	Ethernet link status and 10-Base-T or 100-Base-T indicator	No link	off
		10-Base-T link	amber
		100-Base-T link	green
Ethernet TX/RX	Ethernet activity status and Half Duplex or Full Duplex status	No activity	off
		Half Duplex activity ⁽¹⁾	flashing amber
		Full Duplex activity ⁽¹⁾	flashing green
FAULT	fault condition indicator	lit when a fault condition is present	red or flashing red

(1) Any Ethernet network activity; not necessarily to or from the ENI/ENIW.

After out-of-box power-up, the most common reason for a flashing red fault LED is because an IP address has not yet been assigned via BOOTP. Either set up a BOOTP server to assign an IP address or modify the ENI/ENIW configuration to use a specific IP address or to obtain an IP address via a DHCP server.

For more detailed information on LED operation, see Chapter 9, Troubleshooting.

IMPORTANT

The IP addresses in any of the examples in this manual were arbitrarily assigned and should only be used on an isolated Ethernet network. Contact your system administrator for unique IP addresses if you are connecting your Ethernet devices to your employer's Ethernet network.

Default Settings

The ENI/ENIW has the following default settings:

Table 1.4 RS-232 Settings

Setting	Default	Other Options
Baud Rate	Autobaud	see table 4.2
Handshaking (hardware, software)	none	none
Data Bits	8	none
Stop Bits	1	none
Parity	none	none

Table 1.5 DF1 Settings

Setting	Default	Other Options
Duplicate Message Detection	Enabled	none
Error Detection	Auto-detect (for Autobaud)	Auto-detect when Autobaud is true, otherwise CRC
Embedded Response Operation	Disabled ⁽¹⁾	none
DLE ACK Timeout	1 second	none
DLE NAK Receive	3 NAK retries	none
DLE ENQ for Response	3 ENQs retries	none
DF1 Node Address	Don't Care	

(1) Connected controllers should be configured for Embedded Responses Disabled or Auto-detect.

Table 1.6 Ethernet Settings

Setting	Default	Other Options
Ethernet Speed/Duplex ⁽¹⁾	10 Mbps half-duplex (series A, B) Auto Negotiate (series C, D)	0 = Auto Negotiate 1 = 10 Mbps half-duplex 2 = 10 Mbps full-duplex 3 = 100 Mbps half-duplex 4 = 100 Mbps full-duplex
SMTP Username ⁽¹⁾	null	45 character username
SMTP Password ⁽¹⁾	null	45 character password
SMTP Authentication ⁽¹⁾	Disabled	0 = Disabled 1 = Enabled
Configuration Security Mask	000.000.000.000	Valid IP address
Save/Reset ⁽²⁾	n/a	0 = save configuration to flash 1 = simple reset 2 = reset to out-of-box defaults 3 = reset to out-of-box, except maintain current IP configuration
From String	ENI192.168.1.254@eni1761.org ⁽⁴⁾	ENI/ENIW Identifier
IP Address	000.000.000.000 192.168.1.254 ⁽¹⁾	valid IP Address
Subnet Mask	0.0.0.0 ⁽⁵⁾	valid subnet mask
Gateway Address	0.0.0.0	valid IP address
Security Mask 1	0.0.0.0	valid IP address
Security Mask 2	0.0.0.0	valid IP address
Email Server	000.000.000.000	valid IP address
BOOTP Configuration	0	0 = BOOTP initially 1 = BOOTP/DHCP disabled 2 = BOOTP fallback ⁽⁶⁾ 3 = BOOTP always ⁽⁶⁾ 4 = DHCP always ⁽⁶⁾
Baud Rate ⁽³⁾	See page 4-14.	Autobaud enabled with autodetect of CRC/BCC
Ethernet Hardware Address	Factory Value - Read Only (see the nameplate on the unit)	Factory Value

(1) Series D only.

(2) See page 4-19.

(3) Changes to the Baud Rate take effect when the ENI/ENIW power is cycled, or the configuration is saved to flash.

(4) The ENI/ENIW address, 192.168.1.254 will be replaced by the IP address assigned to the ENI/ENIW. For example, the string may be ENI191.225.181.52@eni1761.org. If the ENI/ENIW does not have an assigned IP address, the string will be read as ENI192.168.1.254@eni1761.org for the series D or ENI0.0.0.0@eni1761.org for series A, B, or C.

(5) See page 4-17 for Subnet Mask auto-detect mode details.

(6) Series C and higher.

Operating Modes

Messaging

When the ENI/ENIW is connected to a programmable controller (and connected to an Ethernet network), the controller can be accessed from other devices on Ethernet, or initiate communications to other EtherNet/IP devices.

Email

The ENI/ENIW also support SMTP mail service, which allows a controller to send email messages to any email address on the network. The email can be used to initiate the transmission of data or status information.

Device Compatibility

The ENI/ENIW are compatible with the following devices and applications:

- All MicroLogix, SLC, PLC-5, CompactLogix, FlexLogix, and ControlLogix controllers, which support DF1 Full-Duplex on an available RS-232 port
- Personal Computers using the RSLinx (V2.30.00 and higher) DF1 Full-Duplex Driver
- Other DF1 Full-Duplex compliant products that have at least one RS-232 port, for example, operator interface devices
- RSLinx (V2.31.00 and higher) Ethernet Driver

Series B Enhancements

The 1761-NET-ENI series B features the following enhancements:

- elimination of the need for two ENIs in a CompactLogix, FlexLogix, or ControlLogix system using RSLogix 5000
- ability to use Dynamic Host Configuration Protocol (DHCP)
- two new BOOTP options

The 1761-NET-ENIW has the same features as the 1761-NET-ENI, but includes web-serving capabilities as discussed on page 1-9.

Series C Enhancements

The 1761-NET-ENI/ENIW series C features the following enhancements:

- 10/100-Base-T Ethernet port that auto-negotiates between 10 Megabits per second and 100 Megabits per second, either half-duplex or full-duplex.
- increased temperature range up to 60°C (140°F)
- increased messaging performance

Series D Enhancements

The ENI/ENIW series D features the following enhancements:

- Ability to configure the ENI/ENIW over Ethernet
- Email user authentication for open mail servers
- Ability to force 10 Mbps or 100 Mbps and half-duplex or full-duplex Ethernet configuration
- Diagnostic web-page for Ethernet connections in use
- Revised web-page formats for ENIW

Ethernet Networks

Basic Ethernet Topology

The ENI/ENIW Ethernet connectors conform to ISO/IEC 8802-3 STD 802.3 and utilizes 10/100 Base-T media. Connections are made directly from the ENI/ENIW to an Ethernet switch. The network setup is simple and cost effective. Typical network topology is pictured below.

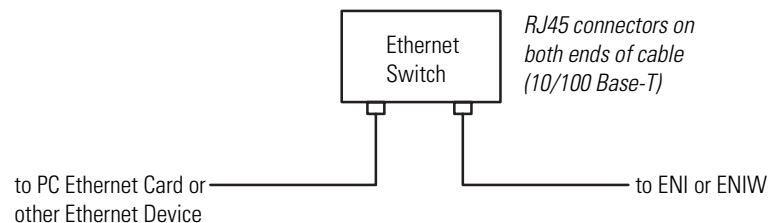

IMPORTANT

The ENI/ENIW provides a 10/100 Base-T, RJ45 Ethernet connector which connects to standard Ethernet hubs and switches via an 8-wire twisted pair straight-through cable. To access other Ethernet mediums, use 10/100 Base-T media converters or Ethernet switches that can be connected together via fiber, thin-wire, or thick-wire coaxial cables, or any other physical media commercially available with Ethernet switches. See page 2-6 for more cable information.

Web Server Functionality

The ENIW enhances operation with web server functionality, enabling it to:

- display 40 data table values on 4 standard Data View web pages consisting of 7 integer and 3 floating-point values on each page,
- display 10 user-configurable data description strings on each Data View web page,
- display a diagnostic page with status and IP Address of active Ethernet connections (series D only),
- password protect writable data files to prevent unauthorized modification, and
- provide 10 user-configurable web page links.

You can access information about the ENI/ENIW via your web browser. Simply enter its TCP/IP address into the address field of your browser.

See Chapter 7 for details on using the ENIW's web server capabilities.

Installation and Wiring

This chapter covers installation and wiring for the ENI/ENIW. It is divided into the following sections:

- European Communities (EC) Directive Compliance
- Safety Considerations
- Mounting
- External Power Supply Wiring
- ENI/ENIW Port Identification
- Ethernet Connections
- RS-232 Port Connections

European Communities (EC) Directive Compliance

This product has the CE mark. It is approved for installation within the European Union and EEA regions. It has been designed and tested to meet the following directives.

EMC Directive

This product is tested to meet the Council Directive 89/336/EC Electromagnetic Compatibility (EMC) by applying the following standards, in whole or in part, documented in a technical construction file:

- EN 50081-2 EMC — Generic Emission Standard, Part 2 — Industrial Environment
- EN 50082-2 EMC — Generic Immunity Standard, Part 2 — Industrial Environment

This product is intended for use in an industrial environment.

Low Voltage Directive

This product is tested to meet Council Directive 73/23/EEC Low Voltage, by applying the safety requirements of EN 61131-2 Programmable Controllers, Part 2 - Equipment Requirements and

Tests. For specific information required by EN 61131-2, see the appropriate sections in this publication, as well as the Allen-Bradley publication Industrial Automation Wiring and Grounding Guidelines For Noise Immunity, publication 1770-4.1.

Open style devices must be provided with environmental and safety protection by proper mounting in enclosures designed for specific application conditions. See NEMA Standards publication 250 and IEC publication 529, as applicable, for explanations of the degrees of protection provided by different types of enclosure.

Safety Considerations

This equipment is suitable for use in Class I, Division 2, Groups A, B, C, D, or non-hazardous locations only. The following WARNING statement applies to use in hazardous locations.

<div style="background-color: black; color: white; padding: 2px; display: inline-block; font-weight: bold;">WARNING</div> 	<p>Explosion Hazard</p> <ul style="list-style-type: none"> • Substitution of components may impair suitability for Class I, Division 2. • Do not replace components or disconnect equipment unless power has been switched off and the area is known to be non-hazardous. • Do not connect or disconnect connectors or operate switches while circuit is live unless the area is known to be non-hazardous. • This product must be installed in an enclosure. All cables connected to the product must remain in the enclosure or be protected by conduit or other means. • The ENI/ENIW must be operated using the external power source. The DC power source switch must be in the EXTERNAL position. • All wiring must comply with N.E.C. article 501-4(b).
---	--

Use only the following communication cables and replacement connectors in Class I Division 2 Hazardous Locations.

Environment Classification	Communication Cable and Connectors	
Class I, Division 2 Hazardous Environment	1761-CBL-PM02 Series C	2707-NC8 Series B
	1761-CBL-HM02 Series C	2707-NC9 Series B
	1761-CBL-AM00 Series C	2707-NC10 Series B
	1761-CBL-AP00 Series C	2707-NC11 Series B

External Power Supply Wiring

WARNING



EXPLOSION HAZARD

In Class I Division 2 applications, an external, Class 2 power supply must be used. The DC Power Source selector switch on the ENI/ENIW must be set to EXTERNAL before connecting the power supply to the ENI/ENIW.

IMPORTANT

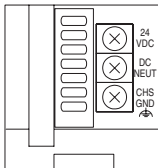

Bottom View

- In non-hazardous locations, external power is not required. Some devices (such as a MicroLogix controller) provide power to the ENI/ENIW via a cable connected to the ENI/ENIW's port 2. Be sure to set the DC power source selector switch to match your particular configuration, CABLE or EXTERNAL.
- Always connect the CHS GND (chassis ground) terminal to the nearest earth ground. This connection must be made whether or not an external 24V dc supply is used.

Mounting

The ENI/ENIW must be mounted in the vertical position, as shown. *Horizontal mounting is not recommended due to thermal considerations.* Allow 50 mm (2 in.) of space on all sides for adequate ventilation. See page A-1 for operating temperature specification.

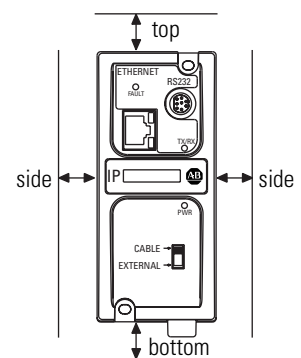
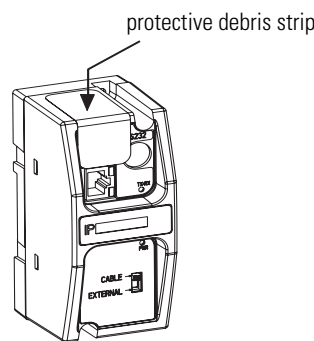

ATTENTION



Do not remove the protective debris strip until after all the equipment in the panel is mounted and wiring is complete. Once wiring is complete, remove the protective debris strip. Failure to remove strip before operating can cause overheating.

DIN Rail Mounting

Installation

1. Mount your DIN rail.
2. Snap the DIN rail latch into the closed position.
3. Hook the top slot over the DIN rail.
4. While pressing the unit against the rail, snap the unit into position.

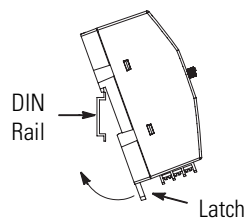

Removal

1. Place a screwdriver in the DIN rail latch at the bottom of the unit.
2. Holding the unit, pry downward on the latch until the unit is released from the DIN rail.

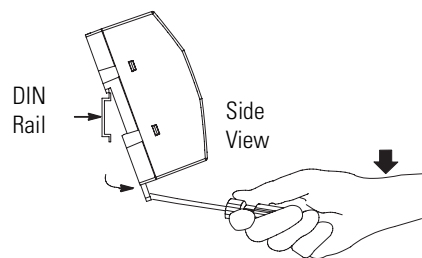

Panel Mounting

Template

See Appendix A for panel mounting dimensions.

Installation

ATTENTION

Be careful of metal chips when drilling mounting holes for your equipment within the enclosure or panel. Drilled fragments that fall into the equipment could cause damage. Do not drill holes above mounted equipment if the protective debris strip has been removed.

1. Remove the mounting template from the back of the installation instructions.
2. Secure the template to the mounting surface.
3. Drill holes through the template.
4. Remove the mounting template.
5. Mount the unit.

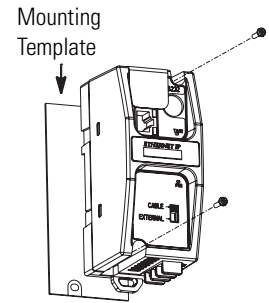

ENI/ENIW Port Identification

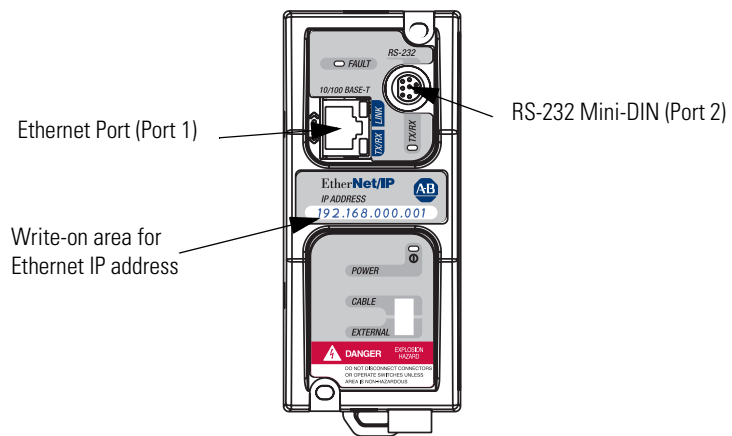

Ethernet Connections

Ethernet 8-Pin 10/100-Base-T Connector (Port 1)

The Ethernet connector is an RJ45, 10/100-Base-T connector. The pin-out for the connector is shown below:

Pin	Pin Name
1	Tx+
2	Tx-
3	Rx+
4	not used
5	not used
6	Rx-
7	not used
8	not used

When to use straight-through and cross-over cables:

- ENI/ENIW Ethernet port to 10/100-Base-T Ethernet switch cables utilize a straight-through pin-out (1-1, 2-2, 3-3, 6-6).
- Direct point-to-point 10/100-Base-T cables connecting the ENI/ENIW Ethernet port directly to another ENI/ENIW Ethernet port (or a computer 10/100-Base-T port) require a cross-over pin-out (1-3, 2-6, 3-1, 6-2).

Ethernet Cables

Shielded and non-shielded twisted-pair 10/100-Base-T cables with RJ45 connectors are supported. The maximum cable length between an ENI/ENIW Ethernet port and a 10/100-Base-T port on an Ethernet switch (without repeaters or fiber) is 100 meters (323 feet). However, in an industrial application, the cable length should be kept to a minimum.

With media converters or Ethernet switches, you can also connect to the following media:

- fiber optic
- broadband
- thick-wire coaxial cable (10-Base-5)
- thin-wire coaxial cable (10-Base-2)

Maintain ENI and ENIW Cable Connections

The unshielded twisted pair (UTP) patch cable on a switch should be labeled and treated as dedicated. Be careful when moving any cables, as port identity may be effected. If you are using a switch and must move the ENI/ENIW to a new port for any reason, power-cycle the interface. The power cycle forces a new Address Resolution Protocol (ARP) sequence which should immediately associate the ENI/ENIW's IP address with the port it is connected to.

To help prevent problems with network communications affected by moving cables, discourage any field personnel from treating the ports of a switch as "all the same".

RS-232 Port Connections RS-232 Connector

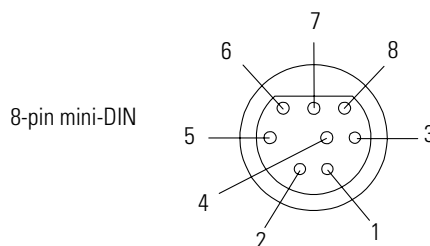

Table 2.1 RS-232 Connector Pin Assignments

Pin	Port 2
1	24V dc
2	ground (GND)
3	no connection
4	ENI/ENIW input data, RxD
5	no connection
6	no connection
7	ENI/ENIW output data, TxD
8	ground (GND)

RS-232 Cables

Port 2 of the ENI/ENIW is an 8-pin mini-DIN RS-232 port that provides connection to DF1 compatible RS-232 devices. The table below describes the RS-232 compatible cables.

ENI/ENIW Connected to:	Catalog Number	Use Cable
MicroLogix 1000, 1100, 1200, and 1500, Channel 0 (all series)	1761-CBL-AM00 1761-CBL-HM02	Mini DIN to Mini DIN 45 cm (17.7 in) 2m (6.5 ft.)
SLC 5/03, SLC 5/04, or SLC 5/05, Channel 0 MicroLogix 1500 LRP, Channel 1 CompactLogix, FlexLogix, or ControlLogix serial ports	1761-CBL-AP00 1761-CBL-PM02	Mini DIN to D-Shell 45 cm (17.7 in) 2m (6.5 ft.)

See page 2-2 for the list of cables that can be used in a hazardous environment.

Operation

This chapter describes ENI/ENIW operation. The following information is included:

- Operation Overview
- Allocation of Ethernet Connections
- ENI and ENIW Functional Overview
- General Ethernet Information
- RSLinx/RSWho Connectivity Example Using ENI/ENIW Interface

Operation Overview

Ethernet is the protocol used to transport TCP/IP messages. On top of TCP, EtherNet/IP is the open protocol used by the ENI and ENIW. EtherNet/IP allows devices to exchange information (data); or to upload, download, and edit logic programs over Ethernet.

To communicate between devices, EtherNet/IP uses a “connection” model. Connections are dedicated paths across Ethernet between devices.

Allocation of Ethernet Connections

The ENI and ENIW support a maximum of 6 connections, allowing simultaneous communication with up to 6 other devices or applications. The connections are dedicated as follows:

Number of Connections	Dedicated to:
2	outgoing messages
2	incoming messages
2	either incoming or outgoing messages

TIP

For peer connections, no more than one connection per destination node is established. If multiple MSG instructions use the same destination node, they use the same connection.

ENI and ENIW Functional Overview

The ENI and ENIW provide EtherNet/IP connectivity for RS-232 devices that use DF1 full-duplex protocol. DF1 full-duplex is an open, point-to-point protocol used in any Allen-Bradley controller with an RS-232 port, and in many other devices. DF1 full-duplex supports up to 255 node addresses. The ENI and ENIW use these node addresses for different functions.

The ENI and ENIW use a memory (node) map to provide access to the different functions you can perform. Each function uses a different group of node addresses. The following table illustrates the ENI and ENIW functions by groups of node numbers:

ENI and ENIW Function	Node Group	Node Function	Valid Data Type	For More Information
Message Routing	Node 100 to 149	Configure Route Address	Integer	see chapter 5
	Node 0 to 49	Route DF1 MSG to IP at Configured Route Address	Integer	see chapter 5
Email	Node 150 to 199	Configure SMTP email address	String	see chapter 6
	Node 50 to 99	Send email message to configured SMTP email address	String	see chapter 6
Web Data	Node 200 to 204	ENIW Web page data	String, integer, or floating point	see chapter 7
ENI and ENIW Configuration	Node 241 to 254	ENI and ENIW Configuration Registers	Integer or String depending on parameter	see chapter 4

General Ethernet Information

Each Ethernet device requires a unique IP address. If your Ethernet network is isolated from the company-wide network, any valid IP address may be used. If your Ethernet hub is connected to a larger Ethernet network, contact your System Administrator for unique IP addresses.

RSLinx/RSWho Connectivity Example Using ENI/ENIW Interface

For this example, the following IP addresses will be assigned to the various Ethernet devices on our network:

Table 3.1 Example Network IP Addresses

IP Address	ENI or ENIW Series	Device
131.200.50.92		SLC 5/05 controller
131.200.50.93		1756-ENBT
131.200.50.94	Series A ENI	1761-NET-ENI #2 (1769-20 or 1769-L3x CompactLogix controller)
131.200.50.95	Series A ENI or B/C/D (ENI or ENIW)	1761-NET-ENI #1 (computer COMM port)

Table 3.1 Example Network IP Addresses

IP Address	ENI or ENIW Series	Device
131.200.50.96		computer's Ethernet card
131.200.50.97	Series B/C/D	1761-NET-ENI/1761-NET-ENIW #3 (1769-L20 or 1769-L3x CompactLogix controller)
131.200.50.98	Series A or B/C/D	1761-NET-ENI/1761-NET-ENIW #4 (MicroLogix 1500)

The subnet mask for each Ethernet device is then, 255.255.0.0.

IMPORTANT The RS-232/DF1 interface between the CompactLogix controller and its ENI/ENIW module, and between the computer (RSLogix5000/RSLinX) and its ENI/ENIW module, should use 38400 baud. This will allow the fastest upload/download of programs.

(For series A and B ENI or series B ENIW only)
When using 38400 baud, the number of Stop Bits in RSLinx and in the CompactLogix controller must be set to 2.

Figure 3.1 Example Ethernet Network

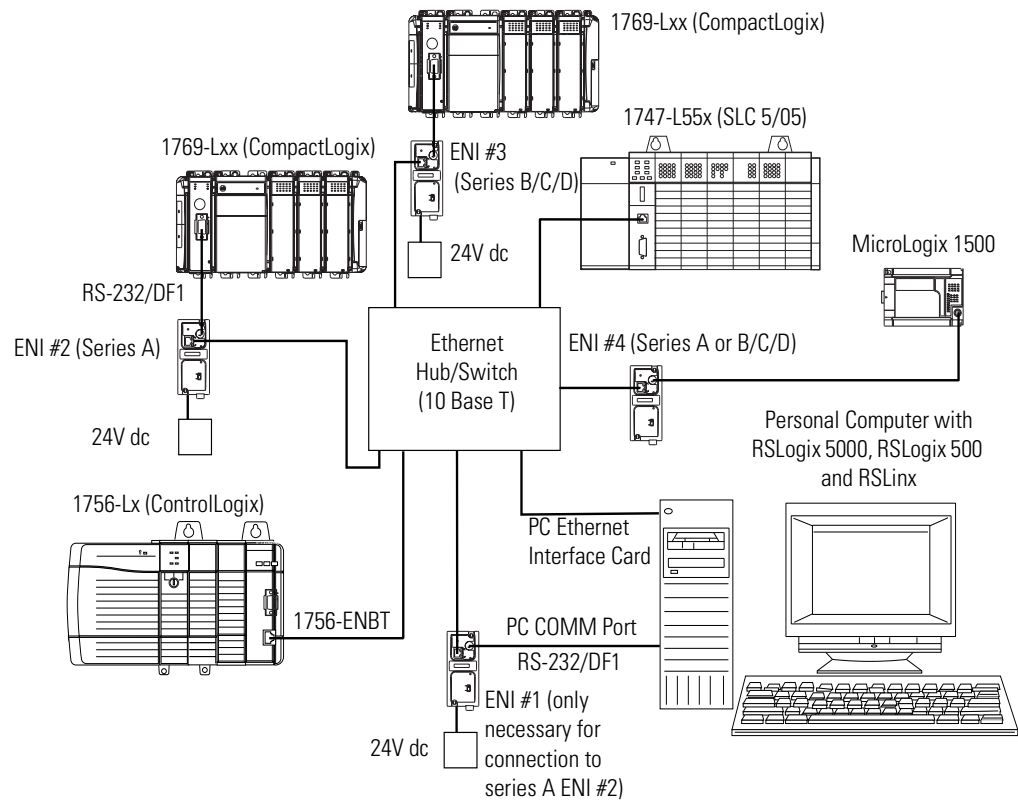

The ENI/ENIW allows you to connect from your PC to controllers over Ethernet. The following procedure can be used when the computer has a connection directly onto Ethernet (PCI card, PCMCIA interface, built in TCP/IP port, etc.) and also when the ENI/ENIW is plugged into the computer's RS-232 (COMM) port.

PC Connected Directly to Ethernet (RSLinx on Ethernet)

IMPORTANT

You must use RSLinx version 2.31.00 or newer to browse with the ENI/ENIW series B or higher via Ethernet to a CompactLogix controller.

Follow these steps to configure RSLinx for Ethernet operation.

1. Open RSLinx and open the driver configuration dialog.

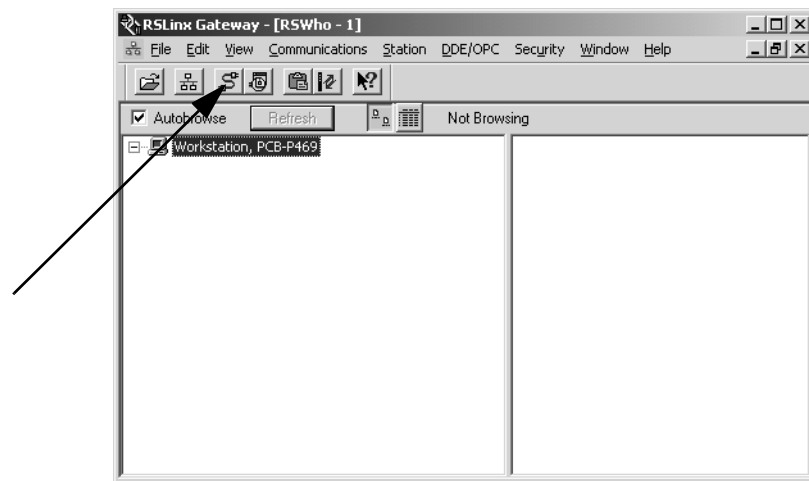

2. Select “Ethernet devices” from the available drivers, and then click “OK” to load the driver into RSLinx.

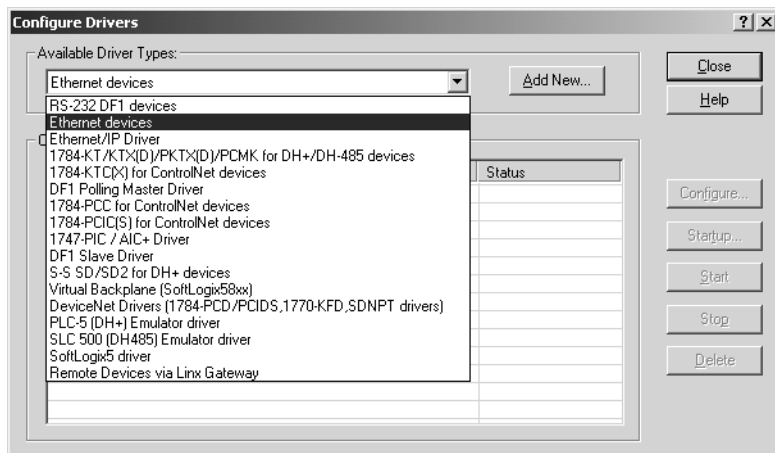

TIP

The RSLinx Ethernet/IP driver may also be used with series B (FRN 2,31) ENIs and higher. The advantage of this driver is that it can ‘discover’ the ENIs on a network even when the IP addresses have not been manually entered. The disadvantage of this driver is that the RSWho browse displays only the ENI and not the MicroLogix controller that is attached to the ENI’s serial port.

Once the Ethernet driver is loaded, either highlight and select “Configure” or simply double click on the Ethernet driver.

3. Click “OK” to accept the default driver name.

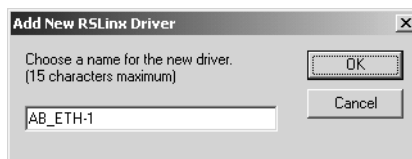

At that point, the station mapping screen will appear as illustrated here. Double click on the row below “**Host Name**”, and enter the TCP/IP addresses that match the devices on your network.

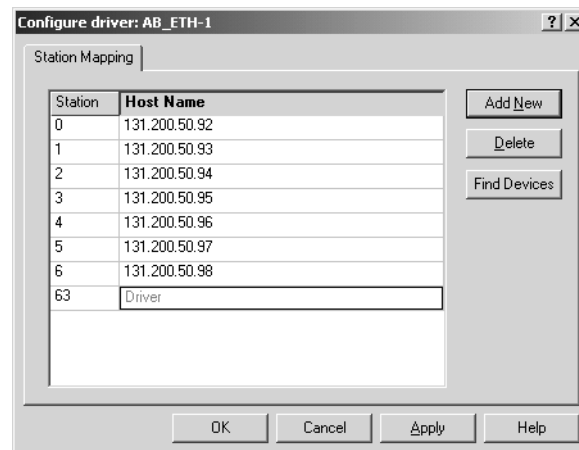
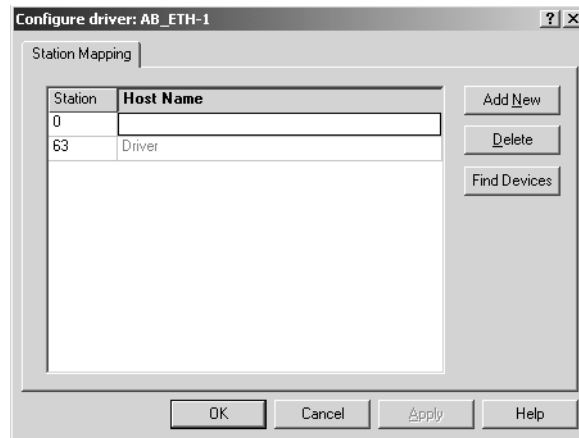

When you are done entering the stations, click OK to close the station mapping window.

4. Open the AB_ETH-1 tree on your computer. Autobrowse should be running and any active device that you have configured should be shown on the screen as illustrated below.

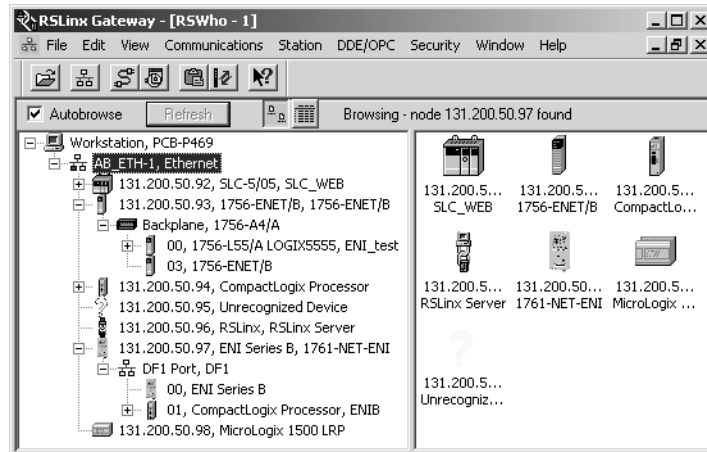
**TIP**

If the ENI or ENIW shows up as an “Unrecognized Device”, you may need to install the latest ENI or ENIW (series B or series C/D) EDS file. You can download this file from <http://www.ab.com/networks/eds/>.

IMPORTANT

You may NOT go online through the AB_ETH-1 Ethernet driver using RSLogix 5000 to the CompactLogix controller at IP address 131.200.50.94, because it is connected to Ethernet using a series A ENI. You MAY go online through the AB_ETH-1 Ethernet driver using RSLogix 5000 to the CompactLogix controller that shows up under the ENI at IP address 131.200.50.97, because it is connected to Ethernet using a series B/C/D ENI.

PC Connected to Ethernet via the ENI or ENIW

As shown below, the ENI/ENIW can also be used to connect a computer's RS-232 port to EtherNet/IP and allow program upload and download and online sessions with a maximum of four EtherNet/IP devices. (Note: The ENI/ENIW limits the number of concurrent outgoing connections to four).

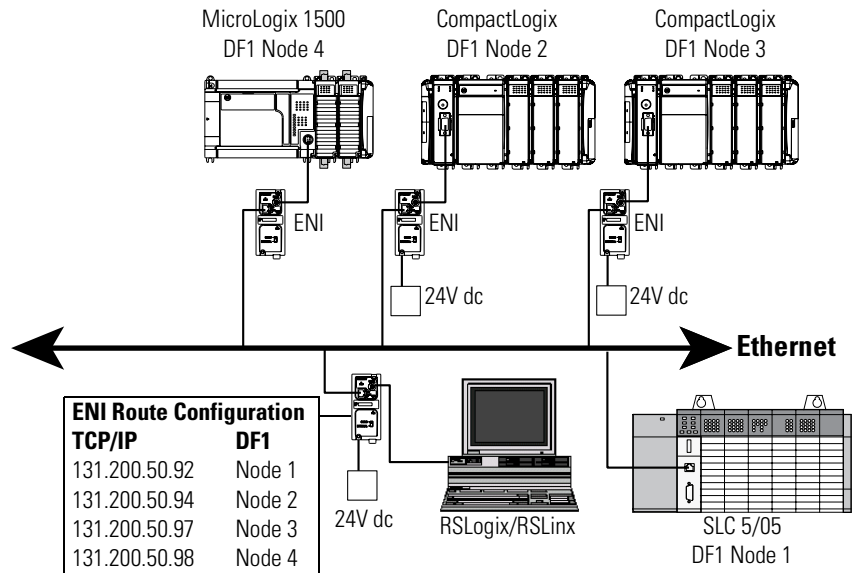

When using the ENI/ENIW as the computer's interface, you can only perform functions supported by RSLogix/RSLinx and ENI/ENIW configuration operations (using the ENI/ENIW Configuration Utility). In addition, before you can use the ENI/ENIW to connect across Ethernet to destination devices in this fashion, the ENI/ENIW must have a valid TCP/IP address, and you must configure the ENI/ENIW's message routing table (nodes 100 to 149). Once the ENI/ENIW is properly configured, you can configure RSLinx.

RSLinx Configuration

1. Open RSLinx.
2. Open the configure drivers dialog box.
3. Select RS-232 DF1 devices. Click Add New.
4. Configure AB_DF1-1 driver to match the example below.

5. Click OK when the AB_DF1-1 driver is configured.

TIP

The 1770-KF3/1747-KE device type only allows you to address nodes 0 to 31 (decimal). In order to address nodes 32 to 49, you must select the 1770-KF2/1785-KE device type and convert the octal addresses to decimal ($40_8 = 32_{10} \dots 61_8 = 49_{10}$).

6. If you have set up the ENI/ENIW Message Routing table with IP addresses in entries between 1 and 31, those devices should respond when you browse the AB_DF1 driver.

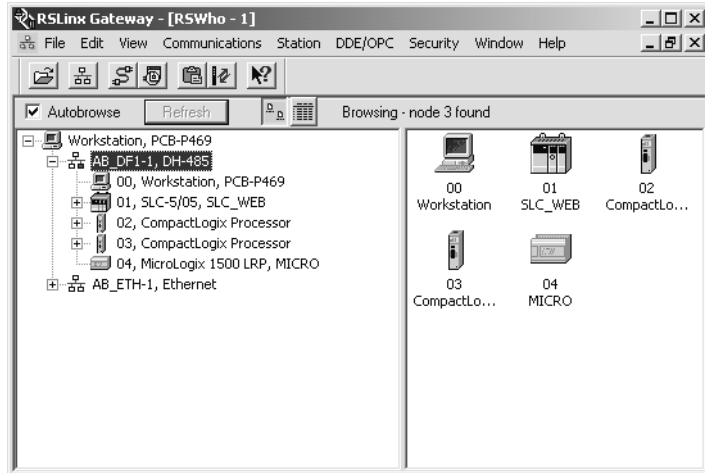
**TIP**

If you use the AB_DF1 driver through an ENI/ENIW, you may go online with CompactLogix controllers using RSLogix 5000 whether they are connected to Ethernet through series A or series B/C/D ENI/ENIW modules.

IMPORTANT

Although you may be able to successfully browse a 1756-Lxx controller located in slot 0 through a 1756-ENxT module using the AB_DF1 driver with an ENI/ENIW, you will *not* be able to go online with that 1756-Lxx controller using RSLogix 5000 programming software. If you attempt to do so, the following error occurs: 'Failed to go online with the controller. No open connection.'

IMPORTANT

You can browse a maximum of four devices at one time from the DF1 driver, because the ENI/ENIW supports only four outgoing connections.

ENI/ENIW Configuration (Nodes 241 to 254)

This chapter describes configuration methods and parameters. It is arranged as follows:

- Configuration Methods
- ENI/ENIW Configuration Utility
- Controller Messaging
- ENI/ENIW Configuration Parameters
- Configuring ENI/ENIW Data Parameters
- Configuring ENI/ENIW String Parameters

Configuration Methods

The ENI/ENIW's IP information can be entered using either:

- the ENI/ENIW Configuration Utility via the RS-232 port
- the ENI/ENIW Configuration Utility via Ethernet, using Com Port Redirector software (for series D only)
- a write message from the Allen-Bradley controller to node address 250 via the RS-232 port
- a BOOTP server over Ethernet (BOOTP configuration is described in Appendix B of this manual)
- a DHCP server over Ethernet (once configured for DHCP)

ENI/ENIW Configuration Utility

The ENI/ENIW Configuration Utility is free software designed for configuring the ENI/ENIW. It is available for download from the Downloads page of any MicroLogix controller at www.ab.com/micrologix.

The Com Port Redirector software, which allows ENI/ENIW configuration over Ethernet, is also available for download from www.ab.com/micrologix.

This section provides information on how to:

- Make configuration selections using the Configuration Utility.
- Use the Configuration Utility over RS-232.
- Use the Configuration Utility over Ethernet with the Com Port Redirector software.

Make Configuration Settings

COM Port Settings

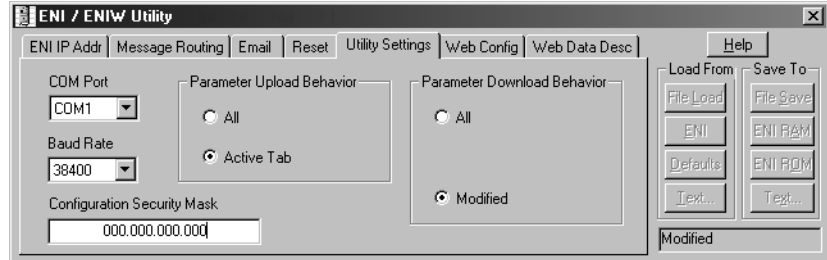

Use the Utility Settings tab to set the following:

- **COM Port** – The PC's RS-232 port that the communications cable is plugged into, or the COM port that the Com Port Redirector is configured for.
- **Baud Rate** – Set the baud rate to match the baud rate configured for the ENI/ENIW. If you're not sure which baud rate the ENI/ENIW is configured for, try the available baud rates listed in Table 4.2, starting with 38,400 and then 19,200. These are the most commonly used baud rates.
- **Parameter Upload Behavior and Parameter Download Behavior** – This setting controls which parameters will be saved or loaded when you use the Load From or Save To buttons.
- **Configuration Security Mask** – The Configuration Security Mask can limit which computers are allowed to configure the ENI or ENIW over Ethernet, based on their IP Address. A Configuration Security Mask of 000.000.000.000 or 255.255.255.255 allows any computer to configure the ENI or ENIW over Ethernet. Otherwise, the Configuration Security Mask acts as a filter on a source IP address such that any mask octet set to the value of 255 becomes 'don't care'. Octets in the source IP and all other fields must match exactly.

The following examples illustrate how the Configuration Security Mask behaves:

If a Configuration Security Mask is set to 192.168.15.255 and an IP address of 203.129.75.23 is received, the packet is rejected because 203.129.75 does not equal 192.168.15. The fourth octet (23) is 'don't care'.

If an IP Address of 192.168.15.76 is received, the packet is processed because the upper three octets match. The fourth octet is still 'don't care'.

If a Configuration Security Mask is set to 192.168.255.76
 all source IP Addresses that equal 192.168.xxx.76
 will be accepted.

RS-232 Baud Rate, TCP/IP Parameters, BOOTP/DHCP, and Ethernet Speed/Duplex Options

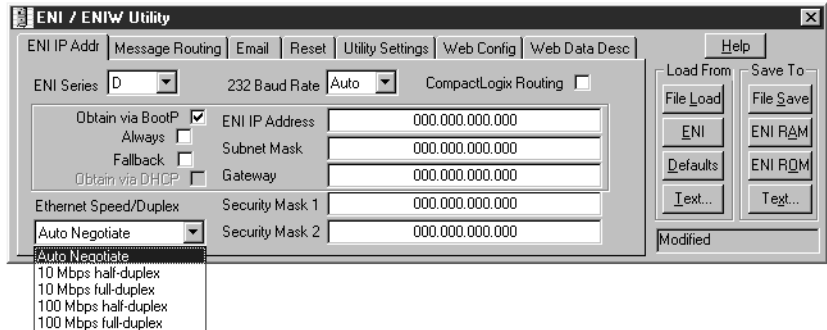

Use the ENI/ENIW IP Addr tab to set the following:

- ENI Series – Select A, B/C or D, depending on which series ENI/ENIW you are configuring.
- 232 Baud Rate – Select a baud rate or choose Autobaud. See page 4-14 for more information.
- TCP/IP Parameters – See page 4-15 for more information on valid addresses.⁽¹⁾
- Obtain via BOOTP – At power-up, if the ENI/ENIW does not already have a saved IP address, it transmits a BOOTP request. If a BOOTP response is received, this IP address is saved for all subsequent power cycles. If a BOOTP response is not received, then the fault LED continues to flash and no further Ethernet communication takes place (series A, B, and C). For series D only, in this situation, Ethernet configuration can be accomplished using the default IP address or 192.168.1.254.
- Other BOOTP/DHCP Options – See the following section on series B and higher options and also see Table 4.3 on page 4-15 for details on the settings.

TIP

If you want to obtain the TCP/IP information via BOOTP, you must do that separately from the ENI/ENIW Configuration Utility. See Appendix B.

(1) Entering leading zeros in the octets of the IP address will not convert the decimal address to a octal value.

Series B, C, and D Options

The latest 1761-NET-ENI/1761-NET-ENIW Configuration Utility features the following options that apply to series B or later modules:

- CompactLogix Routing Checkbox – allows a Logix controller connected to the ENI/ENIW to go online using RSLogix 5000 on Ethernet.
- Always Checkbox – when this checkbox is selected, the ENI/ENIW attempts to obtain the BOOTP IP address on every power cycle. The Always option is only available when Obtain via BOOTP has already been selected.
- Fallback Checkbox – when this checkbox is selected, the ENI/ENIW attempts to obtain a BOOTP IP address on every power cycle. If a response is received, the ENI/ENIW uses the obtained address. If a response is not received, the ENI/ENIW “falls back” to the previously assigned IP address. If an IP address had not previously been assigned, the ENI/ENIW fault LED continues to flash and no further Ethernet communication takes place. The Fallback option is only available when Obtain via BOOTP has already been selected.
- DHCP Checkbox – when this checkbox is selected, the ENI/ENIW attempts to obtain the IP address from a DHCP server on every power cycle. If no DHCP reply is received, then ENI/ENIW fault LED continues to flash and no further Ethernet communication takes place.

Series D Options

The Ethernet Speed/Duplex selection in the Configuration Utility applies only to series D or later units. Select a forced speed and duplex setting or select Auto Negotiate.

Save to ENI/ENIW RAM or ENI/ENIW ROM

You must save the configurations you have set. Click ENI/ENIW RAM for temporary setups or ENI/ENIW ROM to permanently save your settings. If you do not save the settings, they will revert to the last saved settings (or the “out-of-box” if no settings were previously saved).

Email Settings

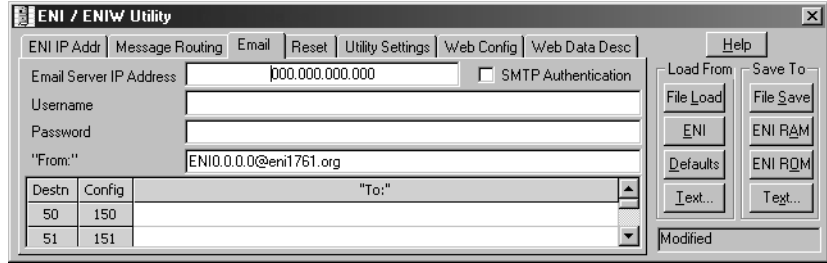

Use the email screen to fill in the information for email messages. Email servers are described on page 4-15. See Chapter 6 for information on the “To” and “From” strings.

The Configuration Utility provides fields for a Username and Password required for authentication to an open SMTP mail server. The SMTP Authentication checkbox, Username, and Password apply only to series D modules.

Message Routing

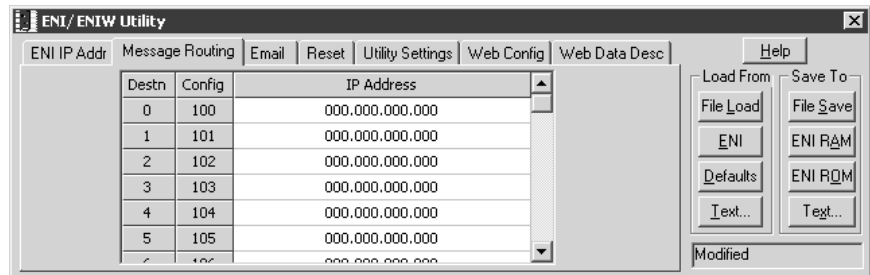

Use the Message Routing screen to fill in the destination addresses for DF1 messaging. Message routing is described in Chapter 5.

Reset

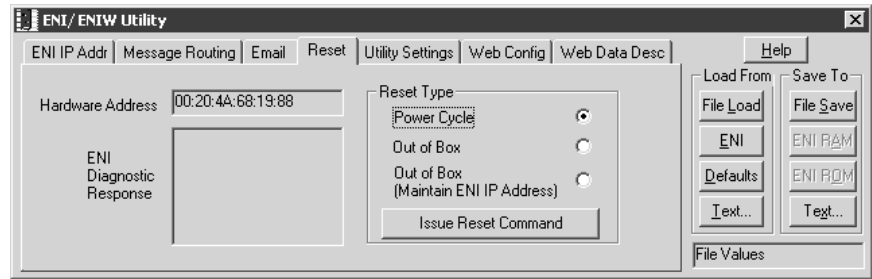

Use the Reset screen to issue reset commands and to set the type of behavior that will occur at reset. The reset behavior options are described on page 4-19.

For configurations uploaded from an ENI, the reset screen also displays information, such as the ENI/ENIW Ethernet hardware address and ENI/ENIW firmware revision.

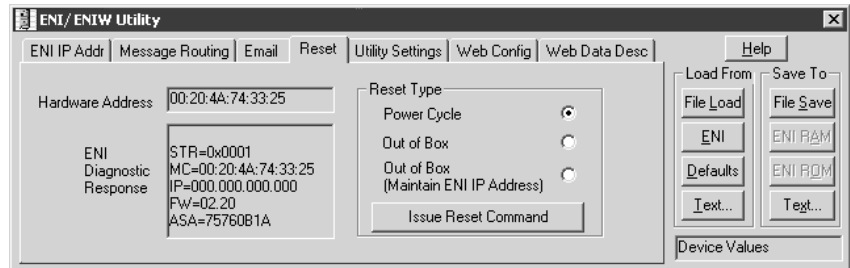

Use the Configuration Utility Over RS-232

TIP

When using the ENI/ENIW Configuration Utility, be sure to use a 1761-CBL-PM02 series C cable between the ENI/ENIW and the computer.

Also, make sure RSLinx is not running a driver that is using the COM port that you plan to use for the ENI/ENIW Configuration Utility.

1. Open the ENI/ENIW Configuration Utility.

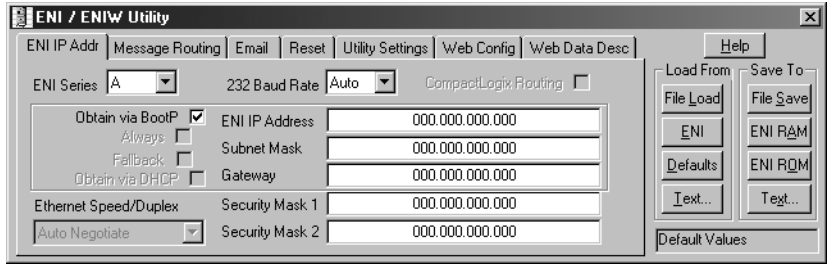

2. On the Utility Settings tab, select the appropriate COM port and baud rate.

- COM Port – The PC’s RS-232 port that the communications cable is plugged into.
- Baud Rate – Set the baud rate to match the baud rate configured for the ENI/ENIW. If you’re not sure which baud rate the ENI/ENIW is configured for, try the available baud rates listed in Table 4.2, starting with 38,400 and then 19,200. These are the most commonly used baud rates.

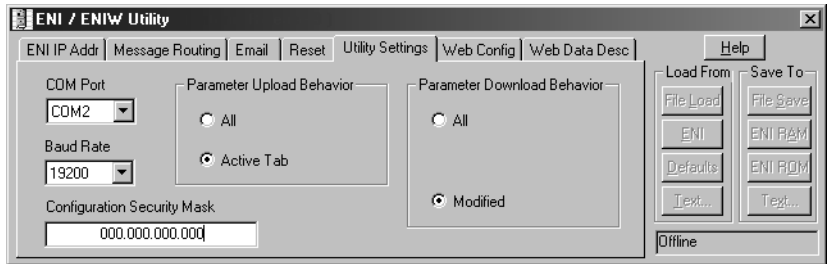

3. Click the (Load From) ENI button.

The configuration is uploaded from the RS-232 com port.

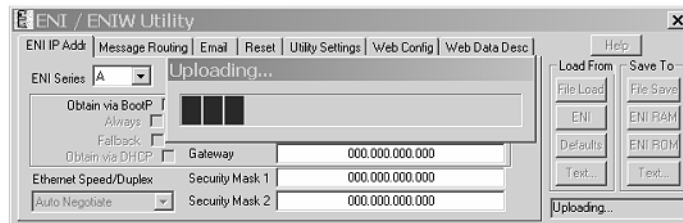

The ENI/ENIW Configuration Utility may now be used for all configuration operations over RS-232.

Use the Configuration Utility Over Ethernet (Series D only)

TIP

When using the ENI/ENIW Configuration Utility via Ethernet, connect the ENI/ENIW to the same subnet as the computer.

Redirect the COM port to the ENI/ENIW IP Address

1. Download the Com Port Redirector software from www.ab.com/micrologix.
2. Install the Com Port Redirector software.
3. Open the Port Redirector configuration utility by selecting Programs>Com Port Redirector>Configuration.

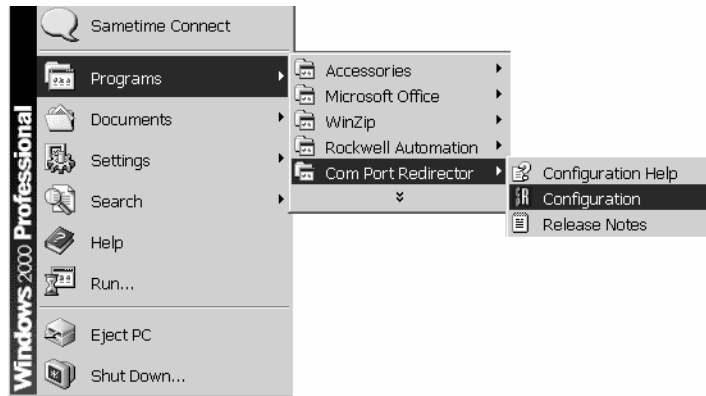

4. The splash screen appears briefly, followed by the configuration screen.
5. Click on the Com Setup button.

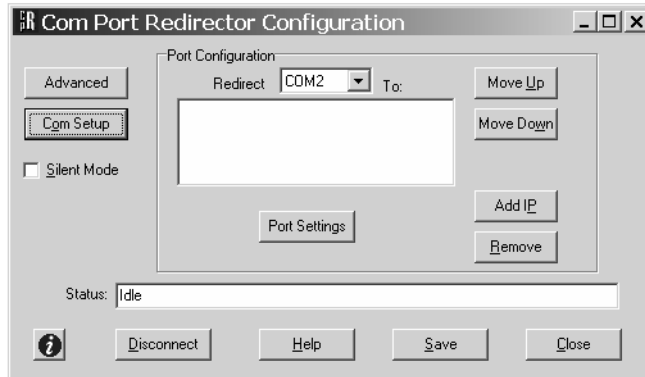

6. Select the port, or ports, you want to redirect and click OK.

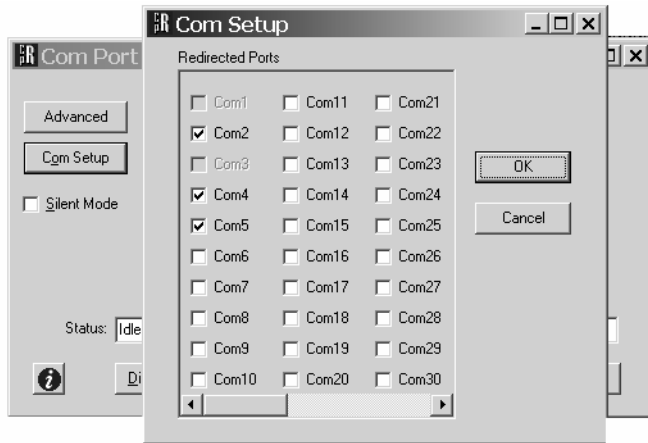

You may either assign each ENI/ENIW its own Com port address, or use only one Com port and modify the IP address that the Com port is configured for before running the ENI/ENIW Configuration Utility.

If a Com port is grayed out, it is in use and cannot be selected.

7. Using the pull-down menu, select the port you want to redirect to the ENI or ENIW.

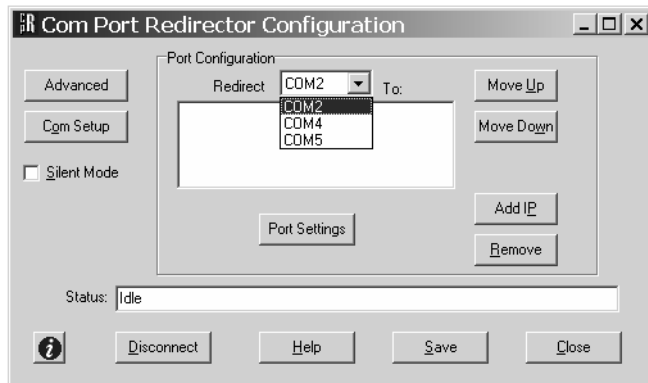

8. Click the Add IP button.

- In the Host field, enter the IP Address of the ENI or ENIW. In the TCP Port field, enter 10001. Click OK.

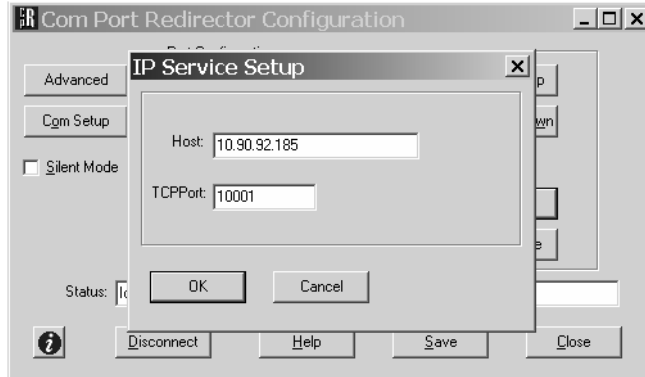

TIP

If a BOOTP or DHCP server provided the IP Address, browse using RSLinx to determine the IP Address. Otherwise, the default out-of-box IP Address for the series D ENI/ENIW is 192.168.1.254.

- The redirect IP Address and port are displayed for COM2.

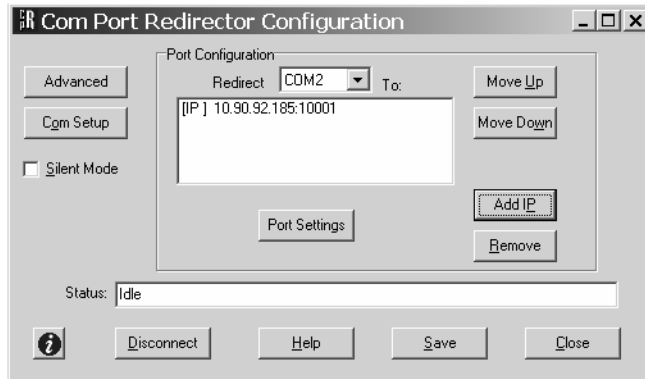

- Click the Port Settings button.

- Select Raw Mode and click OK.

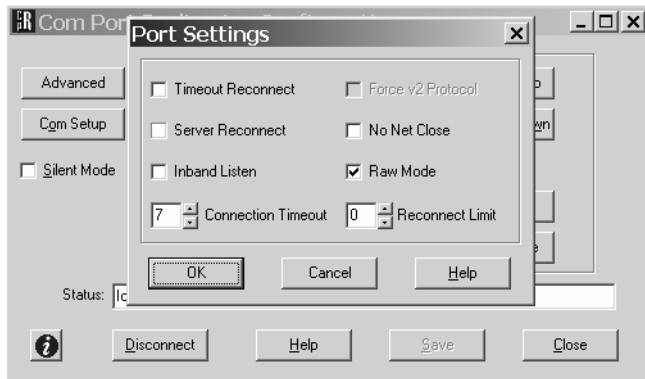

- Click the save button.

14. The software notifies you that changes take effect when the port is reopened. Click OK.
15. Click OK and then close the Com Port Redirector.
16. Reboot the PC, if requested.

Configure the ENI/ENIW

1. Open the ENI/ENIW Configuration Utility.

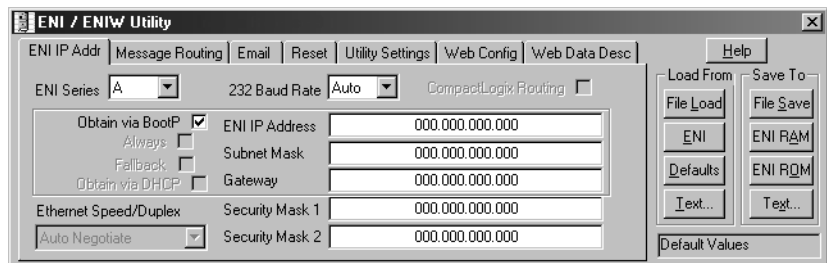

2. On the Utility Settings tab, select the appropriate COM port.

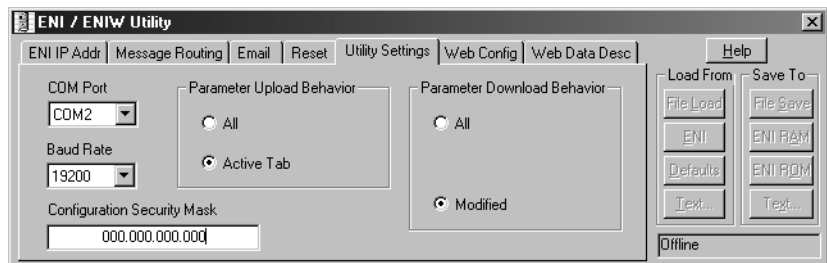

3. Select the ENI IP Addr tab. Click the (Load From) ENI button to upload over Ethernet through the redirected com port.

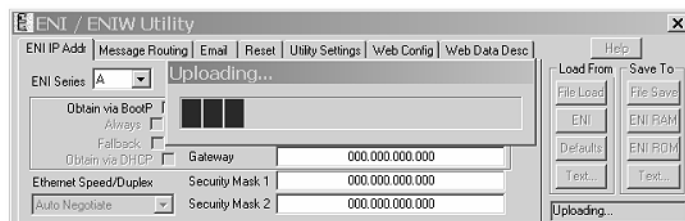

The ENI/ENIW Configuration Utility may now be used for all configuration operations over Ethernet using the Com Port Redirector. The Redirector will automatically operate each time the configured COM port is accessed.

Controller Messaging

When using this method, a write message is used to configure the TCP/IP configuration parameters. A 485CIF write message is initiated to the controller. CIF stands for Common Interface File and is supported by all Allen-Bradley programmable controllers that have an RS-232 port.

TIP

A 485CIF write may also be referred to as a PLC2 Unprotected Write.

The first item to configure is the ENI/ENIW's IP address on your network. See the following section, Configuring ENI/ENIW Data Parameters, for that configuration procedure.

IMPORTANT

The IP addresses in any of the examples in this manual were arbitrarily assigned and should only be used on an isolated Ethernet network. Contact your system administrator for unique IP addresses if you are connecting your Ethernet devices to your employer's Ethernet network.

The configuration parameters are described in more detail beginning on page 4-12.

ENI/ENIW Configuration Parameters

The following table shows the functions that nodes 241 to 255 perform and their default values. Descriptions of each function can be found following the table.

Table 4.1 Configuration Node Functions

Node	Function	Data Type	Number of Elements	Options	Default
255	Reserved				
254	Ethernet Hardware Address	ASCII String	1	Factory Value	Factory Value - Read Only (see nameplate on unit)
253	Baud Rate ⁽¹⁾	Integer	1	See page 4-14.	Autobaud enabled with autodetect of CRC/BCC
252	BOOTP Configuration	Integer	1	0 = BOOTP initially 1 = BOOTP/DHCP disabled 2 = BOOTP fallback ⁽²⁾ 3 = BOOTP always ⁽²⁾ 4 = DHCP always ⁽²⁾	0
251	Email Server	Integers	4	Valid IP Address	000.000.000.000

Table 4.1 Configuration Node Functions

Node	Function	Data Type	Number of Elements	Options	Default
250	TCP/IP Configuration	Integers	4, 8, 12, 16, or 20	Valid IP Address	000.000.000.000 192.168.1.254 ⁽⁵⁾
249	From String	ASCII String	1	ENI/ENIW Identifier	ENI192.168.1.254@eni1761.org ⁽³⁾
248	Save/Reset ⁽⁴⁾	Integer	1	0 = save configuration to flash 1 = simple reset 2 = reset to out-of-box defaults 3 = reset to out-of-box, except maintain current IP configuration	n/a
245	Configuration Security Mask ⁽⁵⁾	Integers	4	Valid IP Address	000.000.000.000
244	SMTP Authentication ⁽⁵⁾	Integer	1	0 = Disabled 1 = Enabled	Disabled
243	SMTP Password ⁽⁵⁾	ASCII String	1	64 character password	null
242	SMTP Username ⁽⁵⁾	ASCII String	1	64 character username	null
241	Ethernet Speed/Duplex ⁽⁵⁾	Integer	1	0 = Auto Negotiate 1 = 10 Mbps half-duplex 2 = 10 Mbps full-duplex 3 = 100 Mbps half-duplex 4 = 100 Mbps full-duplex	10 Mbps half-duplex (series A, B) Auto Negotiate (series C, D)

- (1) Changes to the Baud Rate take effect when the ENI/ENIW power is cycled, or the configuration is saved to flash.
- (2) Series C and higher.
- (3) The ENI/ENIW address, 192.168.1.254 will be replaced by the IP address assigned to the ENI/ENIW. For example, the string may be ENI191.225.181.52@eni1761.org. If the ENI/ENIW does not have an assigned IP address, the string will be read as ENI192.168.1.254@eni1761.org for the series D or ENI0.0.0.0@eni1761.org for series A, B, or C.
- (4) See page 4-19 for more information on Save/Reset.
- (5) Series D only.

These parameters are described in more detail in the following sections.

Node 254 - Ethernet Hardware Address

You will find the hardware address on a label affixed to the ENI/ENIW as shown to the left. The hardware address can also be read from node address 254.

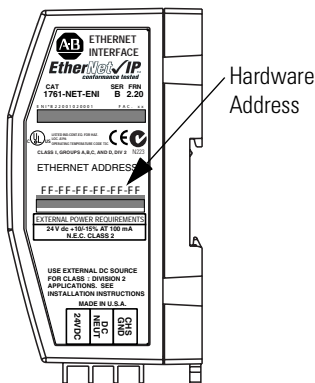

Node 253 - Baud Rate

The first time the ENI/ENIW is powered-up (out-of-the-box), it is set to Autobaud so that it can synchronize to the attached controller. The baud rate can be changed by sending a message to address 253 with one of the configuration values shown in the table below. Changes to the baud rate take effect when the ENI/ENIW power is cycled or when a Save configuration to flash command (write to node 248) is received. The ENI/ENIW also performs a CRC/BCC check when autobaud is operational.

When Autobaud is selected in an ENI/ENIW series B or higher, the ENI/ENIW communicates with the DF1 device attached to it at each power up to determine whether or not the ENI/ENIW should be in 'CompactLogix Routing' mode, and to set the baud rate and checksum.

Table 4.2 ENI/ENIW Baud Rate Options

Baud Rate	Configuration Value	
	For CRC with CompactLogix Routing Disabled (Series A and higher)	For CRC with CompactLogix Routing Enabled (Series B and higher)
Autobaud	0	100
1200	1	101
2400	2	102
4800	3	103
9600	4	104
19.2K	5	105
38.4k ⁽¹⁾	6	106
57.6k ⁽²⁾	7	107
Autobaud Enabled	Autodetect of CRC/BCC occurs when autobaud is selected using values 8 to 99 and 108 to 65535.	

(1) All CompactLogix devices must be configured to use two stop bits when communicating with the ENI/ENIW series A and B at 38.4K.

(2) 38.4K is the maximum serial port speed for Allen-Bradley controllers. The 57.6K setting may only be used with RSLinx.

IMPORTANT

If the controller's baud rate is from 1200 to 38.4K, and the ENI/ENIW is configured for Autobaud, the ENI/ENIW will synchronize with the controller's baud rate. The ENI/ENIW cannot Autobaud to 57.6K to synchronize to the attached controller. You must manually set the baud rate to 57.6K.

Node 252 - BOOTP Configuration

The ENI/ENIW allows the BOOTP request to be disabled by clearing the BOOTP Enable parameter in the channel Configuration File. BOOTP Enable behaves as follows:

Table 4.3 BOOTP Configuration Settings

Node 252 Setting	ENI Configuration Utility Setting	Description	ENI/ENIW Series
0	Obtain via BOOTP and save	initial BOOTP configuration, where ENI/ENIW saves the result in non-volatile RAM (NVRAM) and uses that saved configuration on subsequent power cycles	A, B, C, D
1	Nothing checked	IP address must be configured via the Configuration Utility or via a write to node 250.	A, B, C, D
2	Obtain via BOOTP and Fallback	special BOOTP where ENI/ENIW saves the result in non-volatile RAM (NVRAM), but tries BOOTP first. BOOTP is used only to change the IP address of the ENI/ENIW.	B, C, D
3	Always obtain via BOOTP	traditional BOOTP where ENI/ENIW does not save the result in NVRAM and relies on the BOOTP response for every power cycle	B, C, D
4	DHCP	traditional Dynamic Host Configuration Protocol (DHCP) where the ENI/ENIW does not save the result in NVRAM and relies on a DHCP response for every boot	B, C, D

When BOOTP Enable is disabled, the ENI/ENIW will wait for a manual configuration.

The BOOTP enable/disable setting is only evaluated on power-up. Changes to the BOOTP configuration will not take effect until the next power cycle.

IMPORTANT

If BOOTP/DHCP is disabled, or no BOOTP/DHCP server exists on the network, you must use a soft configuration method to enter or change the IP address for each ENI/ENIW. See page 4-1 for more information.

Node 251 - Email Server

The TCP/IP address stored in this location defines the mail server. The ENI/ENIW sends all email requests to this server, which then sends the email message to the destination.

Node 250 - TCP/IP Configuration

This procedure describes configuration for the TCP/IP parameters. The TCP/IP parameters are configured by sending a message

instruction to the ENI/ENIW (or by using the ENI/ENIW Configuration Utility).

1. Configure a 485CIF/PLC2 write message in the Allen-Bradley controller.

IMPORTANT

To configure TCP/IP parameters in this manner, BOOTP and DHCP must be disabled.

Only PLC2 type or 485CIF write messages can be used to configure the ENI/ENIW, node 250.

2. Set the destination (target) node to 250. Using node address 250 directs this message to the TCP/IP configuration function.
3. The local integer file must be set up for at least 4 integer locations. The first 4 words define the IP address and are required. All remaining variables are optional.

The table below describes the TCP/IP functions that can be configured. The sections following the table describe the functions in more detail.

Table 4.4 TCP/IP Configuration Parameters

Function ⁽¹⁾	Data Type	Length	Notes
IP Address	Integer	4 words	Format aaa.bbb.ccc.ddd (decimal). The ENI/ENIW verifies the first/highest octet of any IP as follows: <ul style="list-style-type: none"> • The first octet is between 1 and 223 and not equal to 127. • The first two octets are not equal to 169.254 or 169.255. • The first octet is 0, and the entire IP is 0.0.0.0. Otherwise the IP address is treated as an error. <i>For example, 0.168.0.75 is an error, or 127.0.0.0 is an error.</i>
Subnet Mask	Integer	4 words	If not sent, the default mask is derived from the class of the IP address as shown in Table 4.5.
Gateway	Integer	4 words	Only needed if a Gateway is present on the Subnet. The default is 000.000.000.000.
Security Mask 1	Integer	8 words	If not present, the default is no security mask 000.000.000.000.
Security Mask 2			

(1) The IP address must be configured. All other functions are optional.

Subnet Mask

A subnet mask is used to interpret IP addresses when the network is divided into subnets. If your network is not divided into subnets, then leave the subnet mask at the default or allow the ENI/ENIW Configuration Utility to assign a default.

The subnet mask defaults to auto-detect mode 'out-of-box'. As long as the subnet mask is not manually set, the auto-detect mode follows the rules as shown below:

Table 4.5 Subnet Mask Auto-Detect Operation

When the IP Address is set to:	And the Subnet Mask is in auto-detect: The Subnet Mask is set to:
Out of Box: 0.0.0.0 ⁽¹⁾	Switch-on auto-detect
Class A address (First octet is 1 to 126)	255.0.0.0
Class B address (First octet is 128 to 191)	255.255.0.0
Class C address (First octet is 192 to 223)	255.255.255.0

(1) 192.168.1.254 for series D.

Subnet Mask Auto-Detect Rules:

- Reading the subnet mask when the IP address is 0.0.0.0 returns a value of 0.0.0.0.
- When you manually configure the subnet mask, auto-detect is switched off and the configured mask is used.
- The ENI/ENIW validates the configured subnet mask and if:
 - The first octet is not equal to 255, the ENI/ENIW returns status 0x10 and reverts to the previous mask, or
 - The first octet is 255, but the remaining mask is not proper, the ENI/ENIW returns status 0x10 and reverts to the previous mask.
- The definition of “proper” is that the mask must be a contiguous series of 1’s with no zeroes in between (i.e. 255.0.0.0 or 255.224.0.0 or 255.192.0.0 are valid, but 255.160.0.0 is not).

Security Mask

The Security Mask, when configured, allows you to restrict controller access to sources with IP addresses that are within some prescribed range. For example, if you wanted to restrict all message sources to be from within a company’s allocated IP address range, a Security Mask could be configured that would block any IP address outside that range. This only applies to messages to the controller. Web page access, for example, is not restricted.

The security masks default value is 0.0.0.0 out-of-box, which is defined as “accept all register session requests”. A Security Mask of 255.255.255.255 is also defined as “accept all register session requests”.

TIP

The security mask acts as a filter on the source IP address such that any mask octet set to the value of 255 becomes “don’t care” octets in the source IP address and all other fields must match exactly.

The follow examples illustrate the behavior of the security masks:

Table 4.6 Security Mask Behavior

Example Condition		Security Mask Behavior
If a security mask is set to 192.168.15.255	and an IP address 203.129.75. 23 attempts to message into the controller	The packet is rejected because 203.129.75 does not equal 192.168.15 (the 4 th octet, 23, is “don’t care”).
	and an IP address 192.168.15.76 attempts to message into the controller	The packet is processed because the upper 3 octets match (the 4 th octet is still “don’t care”).
If a security mask is set to 192.168.255.76		All source IPs that equal 192.168.xxx.76 are accepted because 255 is “don’t care”.

You can use one or two security masks. If you wish to use only one security mask, use Security Mask 1 because it takes precedence over Security Mask 2 (for example, if Security Mask 1 is accepted, Security Mask 2 is not evaluated). Details of the relationship between the two masks are shown in the following table.

Table 4.7 Using Security Mask 1 and Security Mask 2

Example Condition	Security Mask Behavior
Security masks 1 and 2 are evaluated using the following logic:	
If the security mask 1 filter results in an “Accept” decision	security mask 2 is not evaluated and the register session request is processed.
If the security mask 1 filter results in a “Deny” decision	security mask 2 is evaluated as follows: <ul style="list-style-type: none"> • If the security mask 2 filter results in an “Accept” decision, the register session request is processed • If the security mask 2 filter results in a “Deny” decision, the register session request is not replied to and the socket is closed.

Node 249 - From String

Node 249 holds the ASCII string that is sent with any email message initiated by the ENI/ENIW. Criteria for a valid email From String include:

- The From String remains at the default value unless changed by the user. See page 4-12 for default information.
- The From String must contain an “@” symbol.
- The From String cannot contain any spaces or special ASCII characters.
- The maximum length of the From String is 64 characters. Any additional characters are ignored.
- To configure the From String, initiate a message with a string element as the data. The message instruction procedure is shown on page 4-24.

Node 248 - Save/Reset Function

Depending on the value of the Save/Reset option, the ENI/ENIW performs the following operations when receiving a 485CIF/PLC2 Unprotected Write message of one element (integer) to Node 248.

Table 4.8 Save/Reset Function

Value of Save/Reset	ENI/ENIW Operation
0	The ENI/ENIW immediately stops all normal operations and saves the configuration to non-volatile memory.
	IMPORTANT The ENI/ENIW may take up to 60 seconds to complete this save operation. The configuration is not permanently saved until the Save command is sent.
1	The ENI/ENIW immediately stops all normal operations and performs a soft reset.
2	The ENI/ENIW immediately stops all normal operations, performs a soft reset, and returns all parameters to their “out-of-box” settings.
3	The ENI/ENIW immediately stops all normal operations, performs a soft reset, and returns all parameters to their “out-of-box” settings (except for the IP address, Subnet Mask, Gateway ID, and Security Mask).

Node 245 - Configuration Security Mask

The Configuration Security Mask can limit which computers are allowed to configure the ENI or ENIW over Ethernet, based on their IP Address. A Configuration Security Mask of 000.000.000.000 or 255.255.255.255 allows any computer to configure the ENI or ENIW over Ethernet. Otherwise, the Configuration Security Mask allows user to select an IP Address, or range of IP Addresses that may be used for configuration over Ethernet. The mask is configured as follows:

If a Configuration Security Mask is set to 192.168.15.255 and an IP address of 203.129.75.23 is received, the packet is rejected because 203.129.75 does not equal 192.168.15. The fourth octet (23) is 'don't care'.

If an IP Address of 192.168.15.76 is received, the packet is processed because the upper three octets match. The fourth octet is still 'don't care'.

If a Configuration Security Mask is set to 192.168.255.76 all source IP Addresses that equal 192.168.xxx.76 will be accepted.

This procedure describes the application of the Configuration Security Mask. The Configuration Security Mask is configured by sending a message instruction to the ENI/ENIW, or by using the ENI/ENIW Configuration Utility.

1. Configure a 485CIF/PLC2 write message in the Allen-Bradley controller.
2. Set the destination (target) node to 245. Using node address 245 directs this message to the Configuration Security Mask function.
3. The local integer file must be set up for 4 integer locations.

Node 244 - SMTP Email Authentication Checkbox (Series D Only)

Many open mail servers now require user authentication for email. Node 244 allows you to enable or disable the email authentication feature (series D units only).

The ENI/ENIW performs the following Email Authentication configuration operations when receiving a 485CIF/PLC2 Unprotected Write message of one element (integer) to Node 244.

- 0 = Disabled
- 1 = Enabled

Node 243 - SMTP Email Authentication Password (Series D Only)

Many open mail servers now require user authentication for email. Node 243 allows a 45 character Password to be defined for email service (series D units only). Criteria for the Password includes:

- SMTP Email Authentication must be enabled. See Node 244 on page 4-20.
- The Password remains at the default value unless changed by the user. See page 4-12 for the Password default values.
- The Password cannot contain any spaces or special ASCII characters.
- The maximum length of the Password is 45 characters. Any additional characters are ignored.
- To configure the Password, initiate a message with a string element as the data. See the message instruction procedure on page 4-25.

Node 242 - SMTP Email Authentication Username (Series D Only)

Many open mail servers now require user authentication for email. Node 242 allows a 45 character username to be defined for email service (series D units only). Criteria for Username includes:

- SMTP Email Authentication must be enabled. See Node 244 on page 4-20.
- The Username remains at the default value unless changed by the user. See page 4-12 for the Username default.
- The Username cannot contain any spaces or special ASCII characters.
- The maximum length of the Username is 45 characters. Any additional characters are ignored.
- To configure the Username, initiate a message with a string element as the data. See the message instruction procedure on page 4-25.

Node 241 - Ethernet Speed and Duplex Setting (Series D Only)

This node allows speed and duplex settings of 10 Mbps or 100 Mbps and half-duplex or full-duplex to be forced. Auto negotiation may also be selected with this node.

The ENI/ENIW performs the following Ethernet speed/duplex configuration operations when receiving a 485CIF/PLC2 Unprotected Write message of one element (integer) to Node 241.

- 0 = Auto Negotiate
- 1 = 10 Mbps half-duplex
- 2 = 10 Mbps full-duplex
- 3 = 100 Mbps half-duplex
- 4 = 100 Mbps full-duplex

Configuring ENI/ENIW Data Parameters

This example illustrates how to configure the ENI/ENIW's TCP/IP address (Node 250).

TIP

This procedure can also be used for any parameter that requires integer numbers (nodes 50 to 150, 241, 244, 245, 250, 251, 252 and 253).

1. Create an integer data file. Inside the file arrange your TCP/IP data in groups of 4 words (as illustrated in file N50 below).

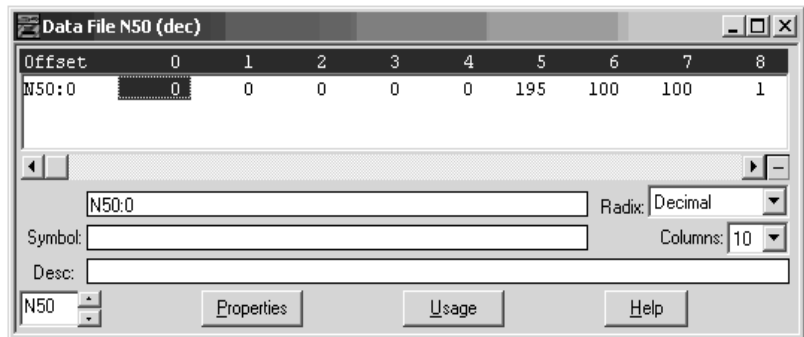

2. Create your message logic using whatever conditional instructions you may need. In this MicroLogix example, bit B3:0/8 is used to condition the message instruction and message file 10, element 1 is used to manage the message session.

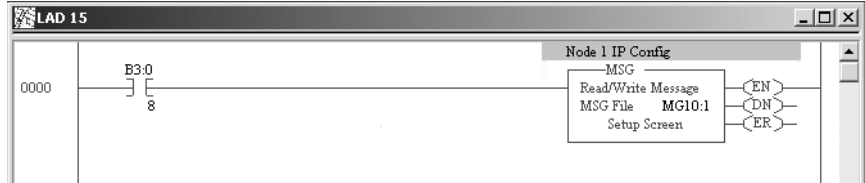

3. Open the message instruction and enter the appropriate variables. The variables are described in Table 4.9.

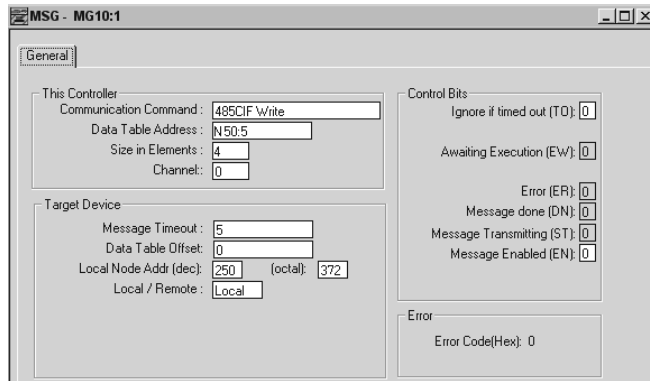

Table 4.9 Message Instruction Variables for Configuring ENI/ENIW Data Parameters

Variable	Setting
This Controller Parameters:	
Communication Command	For the ENI/ENIW configuration, this must be set to: <ul style="list-style-type: none"> • 485CIF for MicroLogix and SLC • a PLC2 Unprotected Write command for CompactLogix and PLC-5
Data Table Address	In this example we are using integer file 50, element 5 (instruction starts at N50:5) to set the ENI/ENIW's IP address to 195.100.100.1.
Size in Elements	For all ENI/ENIW TCP/IP data configuration, always set this to 4 (4 words).
Channel	The RS-232 communication channel that is connected to the ENI/ENIW, typically 0 or 1.
Target Device Parameters:	
Message Timeout	Leave this value at the default.
Data Table Offset	Always 0.
Local Node Addr (dec).	This is the destination node address, in this example it is 101.
Local/Remote	Always Local.

4. With the controller in Run, initiate the message. The new TCP/IP information is transmitted to the ENI/ENIW.

ATTENTION

At this point, the new configuration has NOT been saved to permanent memory. See Node 248 information on page 4-19 for instructions.

Configuring ENI/ENIW String Parameters

Configuring the ENI/ENIW Email From String

This example illustrates configuring the ENI/ENIW Email From String (Node 249). To configure the Email From String, initiate a message with a String element as the data.

IMPORTANT

Email messages can only be initiated by controllers that support String elements. Therefore, this functionality cannot be used with the MicroLogix 1000 family of controllers.

EXAMPLE

Node 249 - Email From String

Node 249 holds the ASCII string that will be sent with any email message initiated by the ENI/ENIW. To configure the Email From String, initiate a message with a string element as the data. To do this, follow the procedure below.

TIP

This procedure can also be used for any parameter that requires string data (nodes 150 to 199, 242, 243, and 249).

1. Create a valid string file element as illustrated below. This example has data file 25 configured for string elements. In File ST25, element 0 has a valid email from string, Station_0@My_Company.com.

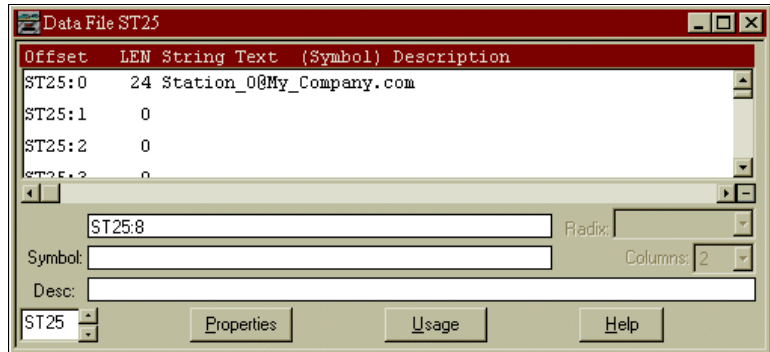

2. Create your message logic using whatever conditional instructions you may need. This example uses bit B3:0/7 to condition the MSG instruction and message file 10, element 16 to manage the message session.

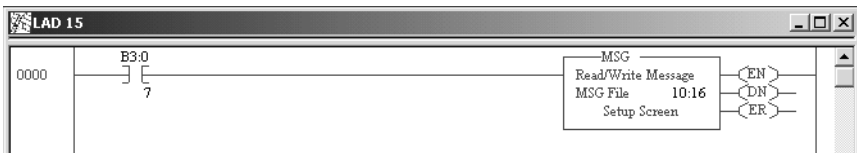

3. Open the message instruction and enter the appropriate variables. The variables are described in Table 4.10.

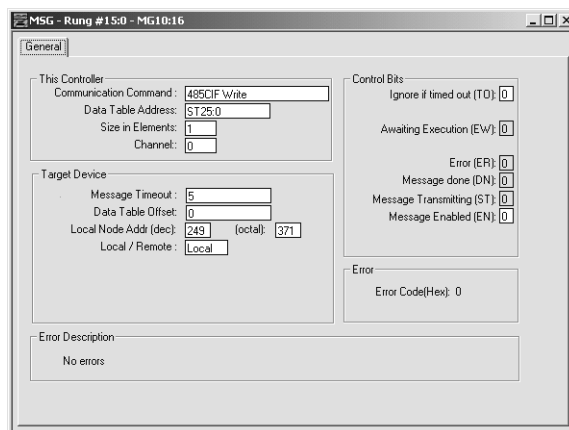

Table 4.10 Message Instruction Variables for Configuring ENI/ENIW String Parameters

Variable	Setting
This Controller Parameters:	
Communication Command	For the ENI/ENIW configuration, this must be set to: <ul style="list-style-type: none"> • 485CIF for MicroLogix and SLC • a PLC2 Unprotected Write command for CompactLogix and PLC-5
Data Table Address	In this example we are using string file 25, element 0 (ST25:0)
Size in Elements	For all ENI/ENIW parameters that require a string configuration, always set this to 1.
Channel	The RS-232 communication channel that is connected to the ENI/ENIW, typically 0 or 1.
Target Device Parameters:	
Message Timeout	Leave this value at the default.
Data Table Offset	Always 0.
Local Node Addr (dec).	This is the destination node address, in this example it is 249.
Local/Remote	Always Local.

Peer-to-Peer Messaging

This chapter describes messaging between the ENI/ENIW and DF1 devices. The following topics are covered:

- Messaging Between the ENI/ENIW and DF1 Devices
- Message to Configuration Nodes (Nodes 100 to 149) and Sending a Message to a Destination Controller (Nodes 0 to 49)

Messaging Between the ENI/ENIW and DF1 Devices

The ENI/ENIW can route a DF1 message received from the attached controller to a compatible destination TCP/IP device, using DF1 node addresses 0 through 49. ENI/ENIW Node addresses 100 through 149 store TCP/IP destination addresses. When the ENI/ENIW receives a write message to nodes 100 to 149, it stores the TCP/IP destination address in the corresponding map register.

To configure the destination TCP/IP addresses, you can use either the ENI/ENIW Configuration Utility, or you can send a 485CIF/PLC2 message to each node as described in this section.

The table below illustrates the relationship between messages and their corresponding configuration addresses.

Table 5.1 Message Routing

ENI/ENIW receives read or write 485CIF/PLC2 message to	ENI/ENIW TCP/IP route configuration	Message forwarded to destination node TCP/IP address
Node 0	Node100	111.222.233.200 (stored at Node 100)
Node 1	Node101	111.222.233.201 (stored at Node 101)

IMPORTANT

When the ENI/ENIW receives a 485CIF/PLC2 write message to a configuration node address (100 through 149), it closes any open communications currently active on that connection and reconfigures the IP address to match the new configuration.

If the received data matches the current configuration, the ENI/ENIW closes any open communications with the destination device.

You must wait at least one second before sending a new message to that node address or you may receive a connection error.

If the ENI/ENIW receives a 485CIF/PLC2 read message to any of its configuration addresses (nodes 100 to 149), the ENI/ENIW responds with the current configuration of that node/address.

Using the configuration shown in Table 5.1; if the controller initiates a read or write message to node 0, the ENI/ENIW forwards the request to the TCP/IP address at Node 100 (111.222.233.200).

When the ENI/ENIW receives a message from the attached controller to Node Address 0 to 49, it looks up the TCP/IP address associated with the address at Nodes 100 to 149. The ENI/ENIW preserves the original DF1 address when sending back a reply.

The following table illustrates the relationship between configuration addresses and their corresponding messaging address.

Table 5.2 Peer-to-Peer Message Routing

Node Number ⁽¹⁾	Function	Node Number	Routing Table	Data Type
0	DF1 Route 0 MSG	100	Route 0 IP Address	Integer (4 words)
1	DF1 Route 1 MSG	101	Route 1 IP Address	Integer (4 words)
2	DF1 Route 2 MSG	102	Route 2 IP Address	Integer (4 words)
3	DF1 Route 3 MSG	103	Route 3 IP Address	Integer (4 words)
↓	↓	↓	↓	↓
49	DF1 Route 49 MSG	149	Route 149 IP Address	Integer (4 words)

(1) See the IMPORTANT note below about assigning Nodes to various devices.

Message to Configuration Nodes (Nodes 100 to 149) and Sending a Message to a Destination Controller (Nodes 0 to 49)

IMPORTANT

In the ENI/ENIW, node addresses 45 through 49 are dedicated for sending messages to any Logix controllers with integral Ethernet ports. In addition, when sending messages to a ControlLogix controller via a 1756-ENBT, the controller **MUST** be in slot 0 of the ControlLogix chassis for the message to be delivered to it.

Node addresses 0 through 44 are to be used for all other Ethernet devices, such as other MicroLogix controllers connected to ENI/ENIW modules or other controllers with integral Ethernet ports, such as SLC 5/05, PLC-5E, and MicroLogix 1100.

To configure the route address (nodes 100 to 149), write a 485CIF/PLC2 message with 4 integer data words. An example is shown in the next section of this chapter.

The procedure to send configuration data (nodes 100 to 149), or data (nodes 0 to 49) is exactly the same as discussed previously in 'Configuring ENI/ENIW Data Parameters' on page 4-22.

Open the message instruction and enter the appropriate variables. The variables are described in Table 5.3 on page 5-4.

The screenshot shows a configuration window titled "MSG - MG10:7" with a "General" tab. The window is divided into three main sections:

- This Controller:**
 - Communication Command: 500CPU Write
 - Data Table Address: N20:10
 - Size in Elements: 1
 - Channel: 0
- Target Device:**
 - Message Timeout: 5
 - Data Table Address: N7:20
 - Local Node Addr (dec): 5 (octal): 5
 - Local / Remote: Local
- Control Bits:**
 - Ignore if timed out (TO): 0
 - Awaiting Execution (EW): 0
 - Error (ER): 0
 - Message done (DN): 0
 - Message Transmitting (ST): 0
 - Message Enabled (EN): 0

Table 5.3 Message Instruction Variables for Sending a Message to a Destination Controller

Variable	Setting
This Controller Parameters:	
Communication Command	Use any command supported by your controller and the target device.
Data Table Address	Use any valid file.
Size in Elements	Use any valid size.
Channel	The RS-232 communication channel that is connected to the ENI/ENIW, typically 0 or 1.
Target Device Parameters:	
Message Timeout	Leave this value at the default.
Data Table Address	Use any valid file.
Local Node Addr (dec).	The destination node address, Nodes 0 to 49 (decimal).
Local/Remote	Always Local.

Email Messages (Node 50 to 99)

This chapter describes using the ENI/ENIW's email feature. The following topics are included:

- Overview
- Configuring Email
- Sending an Email Message

Overview

The ENI/ENIW is capable of transmitting email messages generated by the attached controller. This provides an extremely versatile mechanism to report alarms, status, and other data-related functions.

To send an email message, the controller generates a 485CIF/PLC2 write message, with a string element as the data, to a node number that correlates to the email destination address.

IMPORTANT

Email messages can only be initiated by controllers that support String elements. Therefore, this functionality cannot be used with the MicroLogix 1000 family of controllers.

ENI/ENIW email behavior in a system is described by the following diagram.

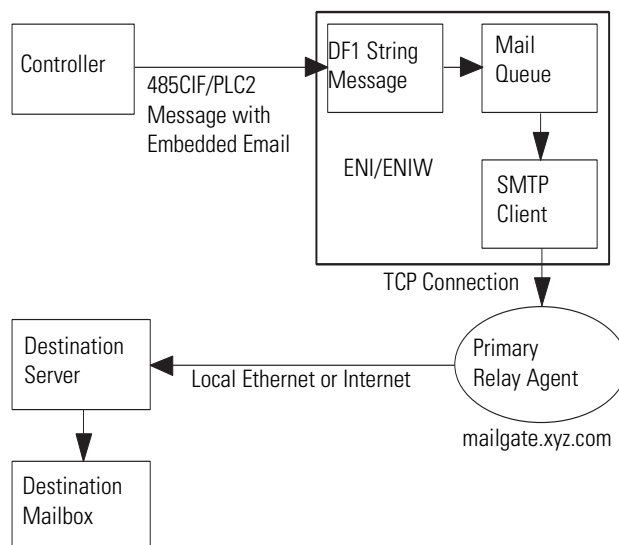

Configuring Email

SMTP Email Address

To configure the email function, at least two parameters must be configured:

- **SMTP Mail Server IP address** - configured by sending a write message to node 251 (email server). See page 4-15 for more information.

IMPORTANT

The ENI/ENIW only accepts the configuration in the form of 4 elements (words) from an Integer file.

- **A “From” String** - configure by sending a write message to node 249 (from string). The string element text can be stored in a String File as shown below. The string element text (ASCII characters) contains the verbatim “from” string. See page 4-24 for more information.

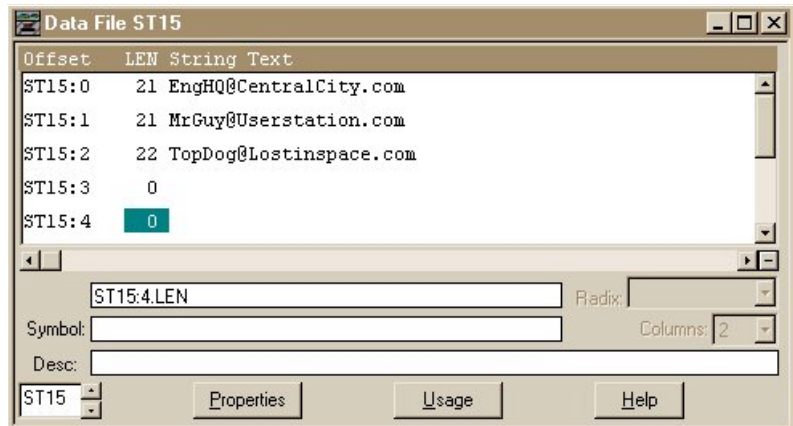

For series D ENI/ENIW only:

- SMTP Authentication -- can be enabled or disabled by sending a write message to node 244. See page 4-20 for more information.
- SMTP Username -- if SMTP Authentication is enabled, Username can be configured by sending a write message to node 242. See page 4-21 for more information.
- SMTP Password -- if SMTP Authentication is enabled, Password can be configured by sending a write message to node 243. See page 4-21.

Destination Addresses

The ENI/ENIW stores email addresses; it does not store the email messages. To store a destination address, write a message to a specific node number (nodes 150 to 199). The message data must be a string element that contains a valid email ASCII text string address, as illustrated in ST15:2 through ST15:5 in the example below.

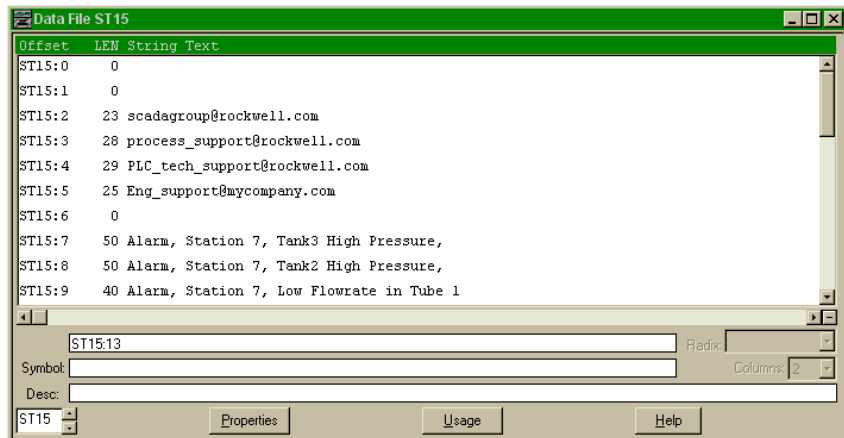

IMPORTANT

Remember the following when setting up destination addresses:

- The ENI/ENIW can store up to 50 email addresses.
- Email addresses can be up to 45 characters long; exceeding this will result in an error.
- The email address must contain an “@” character.
- Email addresses cannot contain any spaces or any other special ASCII characters other than the “@” character.

Message Text

To send the actual email message, the controller generates a write message, with a string element as the data (see ST15:7 to ST15:9 in the example above) to a node number (50 to 99) that correlates to the email address (150 to 199).

Message Fields (to, from, subject)

The ENI/ENIW includes the “to”, “from”, and “subject” fields in the body of the message.

The default “from” text is ENI0.0.0.0@eni1761.org (ENI192.168.1.254@ENI1761.org for series D). This can be changed in the ENI/ENIW configuration, Node 249. See page 6-2 or Chapter 4.

The standard format of the “subject” line is:

Subject: 1761ENI.MSG(*plus the first 32 characters of text*)

For example, if the message text was “The quick brown fox jumped over the lazy dog’s back”, the “subject” line would read:

Subject 1761ENI.MSG(The quick brown fox jumped over)

Sending an Email Message

The ENI/ENIW uses a pair of node addresses to send email or data messages over TCP/IP. To send email, two sets of addresses are used as illustrated in the table below. Node numbers 150 to 199 are used to define or store the actual email address, and nodes 50 to 99 are used to send the string element to the email recipient. The maximum size of the message is 1 string element of 82 bytes.

Table 6.1 Email Address Configuration

Email Message	Email Address Configuration	Description
Node 50	Node 150	The data within the message is sent to Node 50 and forwarded to the email address stored at Node 150.
Node 51	Node 151	The data within the message is sent to Node 51 and forwarded to the email address stored at Node 151.
Node 52	Node 152	The data within the message is sent to Node 52 and forwarded to the email address stored at Node 152.
↓	↓	↓
Node 98	Node 198	The data within the message is sent to Node 98 and forwarded to the email address stored at Node 198.
Node 99	Node 199	The data within the message is sent to Node 99 and forwarded to the email address stored at Node 199.

IMPORTANT

The ENI/ENIW does not support non-printable ASCII characters and may exhibit unpredictable behavior when these characters are used in an email message. Avoid using non-printable ASCII characters such as Carriage Return, Line Feed, Tabs, etc.

TIP

The procedure to send configuration strings (nodes 150 to 199), or message strings (nodes 50 to 99) is exactly the same as discussed, “Configuring ENI/ENIW String Parameters” on page 4-24.

1. Start by configuring a MSG instruction.

The screenshot shows a configuration window for a MSG instruction. The window title is "MSG - Rung #2:0 - MG10:16". The "General" tab is active. The configuration is divided into three main sections:

- This Controller:**
 - Communication Command: 485CIF Write
 - Data Table Address: ST15:5
 - Size in Elements: 1
 - Channel: 0
- Target Device:**
 - Message Timeout: 10
 - Data Table Offset: 0
 - Local Node Addr (dec): 50, (octal): 62
 - Local / Remote: Local
- Control Bits:**
 - Ignore if timed out (TO): 0
 - Awaiting Execution (EW): 0
 - Error (ER): 0
 - Message done (DN): 0
 - Message Transmitting (ST): 0
 - Message Enabled (EN): 0
- Error:**
 - Error Code(Hex): 0

- Open the message instruction and enter the appropriate variables. The variables are described in Table 6.2.

Table 6.2 Message Instruction Variables for Sending an Email Message

Variable	Setting
This Controller Parameters:	
Communication Command	485CIF/PLC2
Data Table Address	Any valid string, such as ST25:21 as shown below.
Size in Elements	1
Channel	The RS-232 communication channel that is connected to the ENI/ENIW, typically 0 or 1.
Target Device Parameters:	
Message Timeout	Increase this value to 10 or greater to avoid MSG timeouts.
Data Table Offset	Always 0.
Local Node Addr (dec).	This is the destination node address. Nodes 50 to 99 send email messages; nodes 150 to 199 configure the email address.
Local/Remote	Always Local.

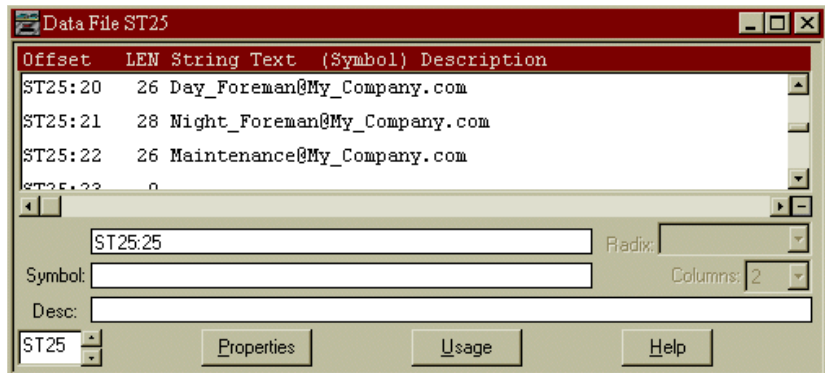

1761-NET-ENIW Web Server Capabilities

This chapter covers using the ENIW's web server features. It describes:

- web browser compatibility
- pages and file types
- defining URL links
- displaying device data on web pages
- ENIW update timer
- posting data to the device
- displaying event data
- using the ENIW Utility to configure the ENIW's web server functionality

You can access information from the ENIW via your web browser. Simply enter the ENIW's TCP/IP address into the address field of your browser.

Web Browser Compatibility

Because the ENIW standard web pages use frames and a cascading style sheet, your browser must support both of these features. The minimum web browser versions are Netscape® 4.7 and Microsoft® Internet Explorer 5.5.

Series D ENIW Web Pages

Series D 1761-NET-ENIW units feature revised format web pages, and the addition of a Diagnostics page. The example graphics and descriptions included in this section are representative of series D units. While the page style and format are different from the series B and C ENIW units, the functionality is similar, except for the addition of the diagnostics page.

The web pages served by the 1761-NET-ENIW consist of two frames. The upper frame is common for all pages, and includes the graphic elements shown below:



The lower frame is scrollable and consists of a group of static and dynamic web pages in tabbed format. The page tabs are labelled:

- Home
- Data View 1 through 4
- Events
- Diagnostics
- Reference

Home Page

The Home page displays a titled, bulleted list of 17 URL links. The first seven links have fixed URLs, providing links to the four Data View pages, the Event page, the Diagnostics page, and the Reference page. The remaining links can be defined by the user as described on page 7-3.

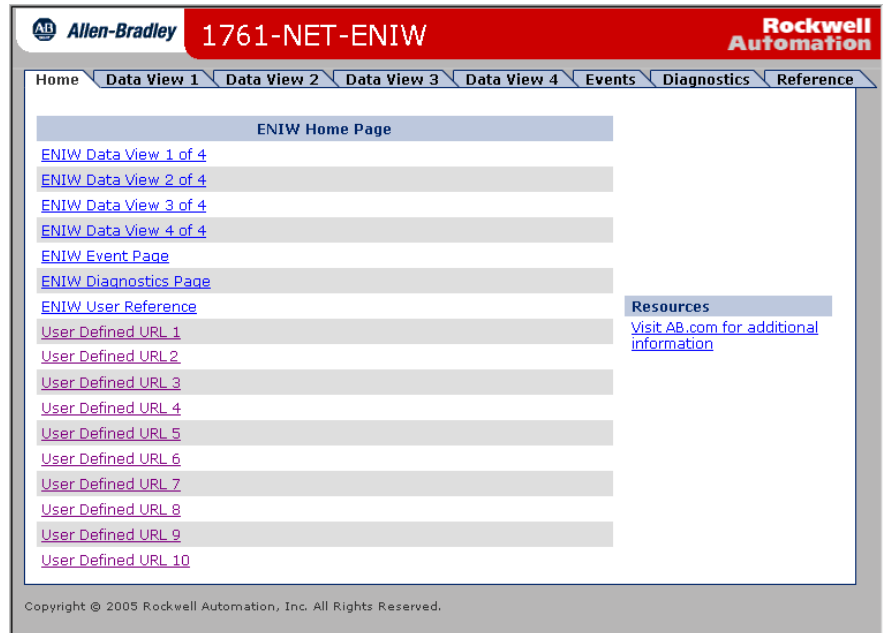

The ENIW Home Page title and the first four links (Data View Pages 1 through 4) can be renamed using the ENI/ENIW Configuration Utility or through the use of write message instructions from the attached controller.

Use a write message of a single string to the offset elements of node 200 as specified in the table below. For SLC or MicroLogix 485CIF Write MSG instruction, enter the offset value in decimal. For Logix

PLC-2 Unprotected Write MSG instruction, enter the element value in octal.

Table 7.1 Renaming Home Page and Data View Pages

Item	Affected Pages	Default Title	Element ⁽¹⁾	Offset ⁽²⁾
Home Page Title	Home Page	ENIW Home Page	0200	1
Page 1 User String	Home and Data View Page 1	Data View Page 1 of 4	05600	23
Page 2 User String	Home and Data View Page 2	Data View Page 2 of 4	06200	25
Page 3 User String	Home and Data View Page 3	Data View Page 3 of 4	06600	27
Page 4 User String	Home and Data View Page 4	Data View Page 4 of 4	07200	29

(1) Use with Logix PLC-2 Unprotected Write MSG instruction.

(2) Use with SLC/MicroLogix 485CIF Write MSG instruction.

The ENIW allows limited HTML formatting. For example, the string 'Go to Allen-Bradley website' would create a bold title.

IMPORTANT

The ENIW does not validate HTML code or provide protection against HTML coding errors.

The links to the ENIW Event Page, ENIW Diagnostics Page, and ENIW User Reference Page cannot be changed.

Defining URL Links

In addition to the 7 URL links already discussed, the ENIW Home Page includes 10 user-defined links that can be customized for your application. These links can be configured using the ENI/ENIW Configuration Utility or using write messages from the attached controller.

To define these links, use write messages to elements of node 200, as listed in Table 7.2. The first write message contains the title of the link and the second write message contains the URL. Each string may be up to 45 characters in length. For SLC or MicroLogix 485CIF Write MSG instruction, enter the offset value in decimal. For Logix PLC-2 Unprotected Write MSG instruction, enter the element value in octal.

EXAMPLE

When defining User Link 1 as a link to the Allen-Bradley website, ST Offset 3 is the user text displayed, in this case 'Go to AB main website'; ST Offset 4 is the URL, in this case 'http://www.ab.com'.

The ENIW allows limited HTML formatting. For example, the string 'Go to Allen-Bradley website' would create a bold title.

IMPORTANT

The ENIW does not validate the URL.

Table 7.2 Defining URL Links on the Home Page

Node 200		Defines	For User Link
Offset ⁽¹⁾	Element ⁽²⁾		
3	0600	Title	1
4	01000	URL	
5	01200	Title	2
6	01400	URL	
7	01600	Title	3
8	02000	URL	
9	02200	Title	4
10	02400	URL	
11	02600	Title	5
12	03000	URL	
13	03200	Title	6
14	03400	URL	
15	03600	Title	7
16	04000	URL	
17	04200	Title	8
18	04400	URL	
19	04600	Title	9
20	05000	URL	
21	05200	Title	10
22	05400	URL	

(1) Use with SLC/MicroLogix 485CIF Write MSG instruction.

(2) Use with Logix PLC-2 Unprotected Write MSG instruction.

TIP

Unused links cannot be removed from the list. Rename them 'reserved' to indicate they are not used.

Links may also be configured with the ENI/ENIW Configuration Utility.

Displaying Device Data

The four Data View pages show data pushed to the ENIW by the attached device. If no data has been written to the ENIW by the attached device or configuration utility, these pages display empty cells. The integer and floating-point data on this page is volatile and is cleared every time the ENIW boots.

Each of the four Data View pages are titled with either the default "Data View Page 1 of 4" etc., or with user-defined page names. See page 7-3 for information on how to rename the Data View pages.

Data View pages display string data in column 1 and either integer or floating point data in column 2.

Figure 7.1 Data View Page

The screenshot shows a web browser window titled "1761-NET-ENIW - Microsoft Internet Explorer provided by Rockwell Automation". The address bar shows "http://10.90.92.172". The page header includes the Allen-Bradley logo and "1761-NET-ENIW" in a red banner, with the Rockwell Automation logo on the right. A navigation menu contains "Home", "Data View 1", "Data View 2", "Data View 3", "Data View 4", "Events", "Diagnostics", and "Reference". The main content area is titled "ENIW Data View 1 of 4" and contains a table with the following data:

Data Description	Writes from Controller	Writes to Controller	
Descriptive text; Data View Page 1 Line 1	68	<input type="text"/>	N50:00
Descriptive text; Data View Page 1 Line 2	59	<input type="text"/>	N50:01
Descriptive text; Data View Page 1 Line 3	43	<input type="text"/>	N50:02
Descriptive text; Data View Page 1 Line 4	60	<input type="text"/>	N50:03
Descriptive text; Data View Page 1 Line 5	65	<input type="text"/>	N50:04
Descriptive text; Data View Page 1 Line 6	1	<input type="text"/>	N50:05
Descriptive text; Data View Page 1 Line 7	68	<input type="text"/>	N50:06
Descriptive text; Data View Page 1 Line 8	8.0000000	<input type="text"/>	F51:00
Descriptive text; Data View Page 1 Line 9	3.4560001	<input type="text"/>	F51:01
Descriptive text; Data View Page 1 Line 10	0.0000000	<input type="text"/>	F51:02

String Data

String Data for the Data View pages is written to Node 201, offset elements 1 to 40 as described in Table 7.3. Strings are left-justified.

For SLC or MicroLogix 485CIF Write MSG instruction, enter the offset value in decimal. For Logix PLC-2 Unprotected Write MSG instruction, enter the element value in octal.

Figure 7.2 Example Write to First String on Second Data View Page

MSG - MG9:0 : (1 Elements)

General

This Controller

Channel: 0 (Integral)

Communication Command: 485CIF Write

Data Table Address: ST10:0

Size in Elements: 1

Target Device

Message Timeout: 5

Data Table Offset: 11

Local Node Addr (dec): 201 (octal): 311

Local / Remote: Local

Control Bits

Ignore if timed out (TO): 0

Awaiting Execution (EW): 0

Error (ER): 0

Message done (DN): 0

Message Transmitting (ST): 0

Message Enabled (EN): 0

Error

Error Code(Hex): 0

Error Description

No errors

Integer Data

Integer data for the Data View pages is written to Node 202, offset elements 0 to 27, as described in Table 7.3. Integers are displayed as right-justified, signed decimal numbers from -32768 to +32767.

IMPORTANT

The 1761-NET-ENIW does not support either 485CIF Writes or PLC2 (Unprotected Writes) for displaying integer or floating-point device data. Instead, the web page DST of the ENIW uses the SLC-type write (Protected Type Logical Write with three address fields), which allows the data type and element index to be relevant.

Figure 7.3 Example Write to First Integer on Second Data View Page

The screenshot shows a configuration window titled "MSG - MG9:1 : (1 Elements)". The "General" tab is active. The "This Controller" section includes: Channel: 0 (Integral), Communication Command: 500CPU Write, Data Table Address: N7:0, and Size in Elements: 1. The "Target Device" section includes: Message Timeout: 5, Data Table Address: N7:7, Local Node Addr (dec): 202 (octal): 312, and Local / Remote: Local. The "Control Bits" section includes: Ignore if timed out (TO): 0, Awaiting Execution (EW): 0, Error (ER): 0, Message done (DN): 0, Message Transmitting (ST): 0, and Message Enabled (EN): 0. The "Error" section shows Error Code(Hex): 0. The "Error Description" section shows "No errors".

Floating-point Data

Floating-point data for the Data View pages is written to Node 203, offset elements 0 through 11, as described in Table 7.3. Floating-points in column 2 are right-justified with 7 significant digits plus the decimal point. If an exponent is required, it is displayed as 'e±xx' with one significant digit to the left of the decimal point. The valid range is $\pm 1.175495e-38$ to $\pm 3.402823e+38$.

Figure 7.4 Example Write to First Floating-Point on Second Data View Page

The screenshot shows a configuration window titled "MSG - MG9:2 : (1 Elements)". The "General" tab is active. The "This Controller" section includes: Channel: 0 (Integral), Communication Command: 500CPU Write, Data Table Address: F8:0, and Size in Elements: 1. The "Target Device" section includes: Message Timeout: 5, Data Table Address: F8:3, Local Node Addr (dec): 203 (octal): 313, and Local / Remote: Local. The "Control Bits" section includes: Ignore if timed out (TO): 0, Awaiting Execution (EW): 0, Error (ER): 0, Message done (DN): 0, Message Transmitting (ST): 0, and Message Enabled (EN): 0. The "Error" section shows Error Code(Hex): 0. The "Error Description" section shows "No errors".

Writing Data to the ENIW

The following table summarizes how string, integer, and floating-point device data is written to the ENIW.

Table 7.3 Writing Device Data to ENIW

Data Type	Displayed in		Write to Node	Data View 1		Data View 2		Data View 3		Data View 4	
	Column	Row		Offset ⁽¹⁾	Element ⁽²⁾	Offset ⁽¹⁾	Element ⁽²⁾	Offset ⁽¹⁾	Element ⁽²⁾	Offset ⁽¹⁾	Element ⁽²⁾
String	1	1	201	1	0200	11	02600	21	05200	31	07600
		2		2	0400	12	03000	22	05400	32	10000
		3		3	0600	13	03200	23	05600	330260	10200
		4		4	01000	14	03400	24	06000	34	10400
		5		5	01200	15	03600	25	06200	35	10600
		6		6	01400	16	04000	26	06400	36	11000
		7		7	01600	17	04200	27	06600	37	11200
		8		8	02000	18	04400	28	07000	38	11400
		9		9	02200	19	04600	29	07200	39	11600
		10		10	02400	20	05000	30	07400	40	12000
Integer	2	1	202	0		7		14		21	
		2		1		8		15		22	
		3		2		9		16		23	
		4		3		10		17		24	
		5		4		11		18		25	
		6		5		12		19		26	
		7		6		13		20		27	
Floating-Point	2	8	203	0		3		6		9	
		9		1		4		7		10	
		10		2		5		8		11	

(1) Use with SLC/MicroLogix 485CIF Write MSG instruction.

(2) Use with Logix PLC-2 Unprotected Write MSG instruction.

Auto-Refresh of Data View Pages

By default, each Data View page has an update frequency of 10 seconds. You can enter a refresh time in seconds (5 to 9999) and post this information to the ENIW by clicking anywhere within the frame.

Figure 7.5 Auto-refresh Field

The screenshot shows a configuration interface with the following elements:

- Input field: "Enter auto-refresh rate in seconds" with the value "10". An arrow points to this field.
- Input field: "Password required to submit writes" with the value "DISABLE".
- Text: "Only values CHANGED will be affected" with a "Write to Device" button.
- Text: "Clear all values" with a "Clear Values" button.
- Text: "Update Timer" with the value "6602".

TIP

To avoid excessive loading of the Ethernet network, set the refresh rate as long as is practical for your application and set the value to 9999 when not in use.

ENIW Update Timer

The ENIW provides a counter displaying the time, in seconds, since the last PLC write to the ENIW. The counter resets to 0 whenever the ENIW detects a valid write on one of the following nodes:

- 201 (Strings)
- 202 (Integers)
- 203 (Floating-points)
- 204 (Event Strings)
- 205 (Null String to Clear)

The counter displays a maximum value of 65,535 seconds. Once the counter reaches that maximum, it displays a value of 65,535 until it detects a valid write. The counter is viewable on all four of the ENIW's Data View pages.

Figure 7.6 ENIW Update Timer

The screenshot shows a configuration interface with the following elements:

- Input field: "Enter auto-refresh rate in seconds" with the value "10".
- Input field: "Password required to submit writes" with the value "DISABLE".
- Text: "Only values CHANGED will be affected" with a "Write to Device" button.
- Text: "Clear all values" with a "Clear Values" button.
- Text: "Update Timer" with the value "6936". An arrow points to this field.

■ Posting Data to the Device

Each of the four Data View pages has the option for user updates to the attached device using 500CPU/SLC-type write messages. Each of these pages protects data using a unique, case-sensitive password containing a maximum of 8 characters. You must enter the correct password to enable device update.

Setting Passwords for Data View Pages

Passwords for the Data View pages are configured using 485CIF string writes to elements of Node 200, as listed in Table 7.4.

For SLC or MicroLogix 485CIF Write MSG instruction, enter the offset value in decimal. For Logix PLC-2 Unprotected Write MSG instruction, enter the element value in octal.

Table 7.4 Setting Passwords

To set a password for:	write a string to Node 200:	Default password
Page 1	offset 24, element 06000	none; writes disabled
Page 2	offset 26, element 06400	
Page 3	offset 28, element 07000	
Page 4	offset 30, element 07400	

A page's password can configure the ENIW to disable device update or to remove the password protection. To disable device update, enter a null string in the password field. To allow device update, enter a case-sensitive string of one to eight characters in the password field. To permit widespread access, use a "*" password.

Passwords may also be configured from the ENI/ENIW Configuration Utility.

Posting Data

Values entered in column three of the Data View pages are written by the ENIW to the attached device once you've entered the password after displaying the page and clicking on the Write to Device button. The ENIW writes one value at a time to the data table addresses shown in the table below. (Multiple values are not combined into one SLC type Write message). The Data Table addresses are also reflected in column four of each user page.

Table 7.5 Data Table Addresses for Data View Pages

Row	Data Table Addresses			
	Page1	Page2	Page3	Page4
1	N50:0	N50:7	N50:14	N50:21
2	N50:1	N50:8	N50:15	N50:22
3	N50:2	N50:9	N50:16	N50:23
4	N50:3	N50:10	N50:17	N50:24
5	N50:4	N50:11	N50:18	N50:25
6	N50:5	N50:12	N50:19	N50:26
7	N50:6	N50:13	N50:20	N50:27
8	F51:0	F51:3	F51:6	F51:9
9	F51:1	F51:4	F51:7	F51:10
10	F51:2	F51:5	F51:8	F51:11

Integer data, written to N50 can be in the range of -32768 to +32767. Floating point data, written to F51, can be any valid 32-bit floating point number. However, ASCII representation is limited to 7 characters plus the decimal and any exponents.

Values that do not change are not written to the device. The data is not validated by the ENIW. Failed writes are indicated by six question marks (??????).

TIP

The device updates run at a slightly higher priority than regular EtherNet/IP network traffic. However, the ENIW does not guarantee delivery or write performance and will discard data after the standard DF1 retry and timeout periods.

Display Event Data

The Event page is a dynamic page that displays lines buffered by the ENIW as a last specified number of events (Event Log) as shown below.

Figure 7.7 Example Event Page

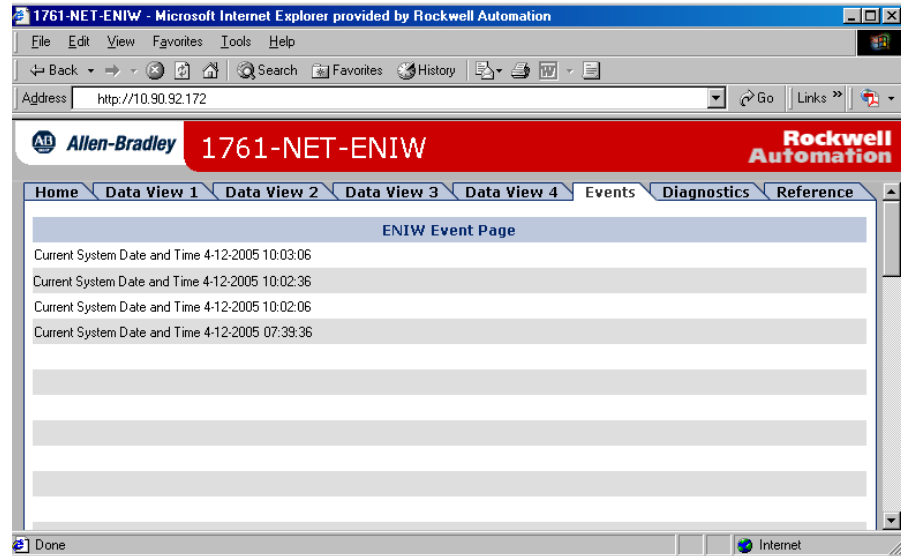

The Event page displays a log of events in a buffered list composed of up to 50 string elements. Each string is displayed in a single line on the page.

The event log displays the last number (n) of strings received, with the newest message at the top. Once the buffer is full, each new string received overwrites the oldest.

Strings written by the attached device to the ENIW to node 204 at element 0 are added to the Event Log.

A string written to node 205 clears the buffer.

Display Diagnostic Data

A Diagnostics page has been added to series D ENI/ENIW units. The diagnostics page provides module specific information, as well as a dynamic display of ENI/ENIW Ethernet connection utilization.

The ENI/ENIW can support 6 concurrent TCP/IP connections; 2 incoming; 2 outgoing; and two that can be allocated as either incoming or outgoing.

Each TCP/IP connection simultaneously supports:

- 4 CIP connections
- 5 Unconnected sends

Figure 7.8 Diagnostic Page

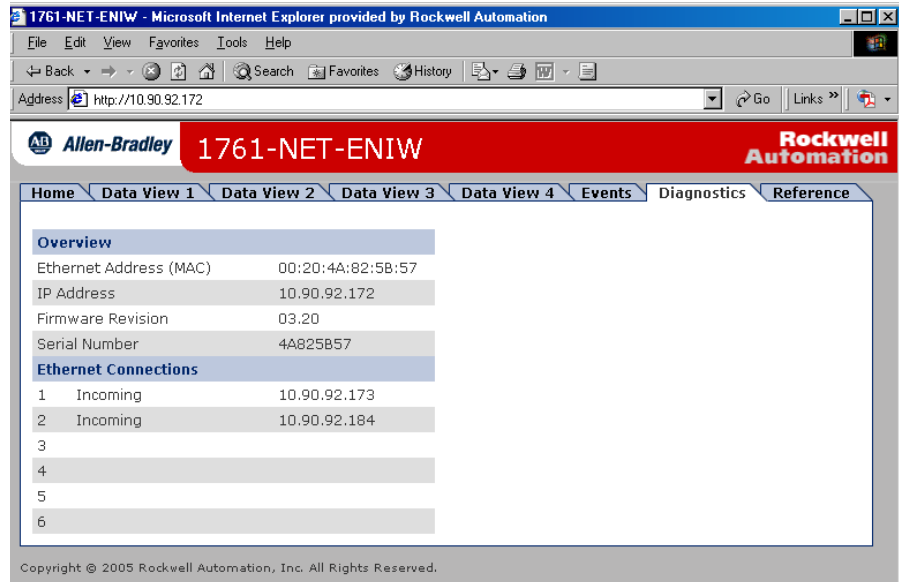

Display Configuration

The reference page displays a summary of ENIW configuration details. It details the configuration nodes used to read or write ENIW configuration.

Figure 7.9 Example Reference Page

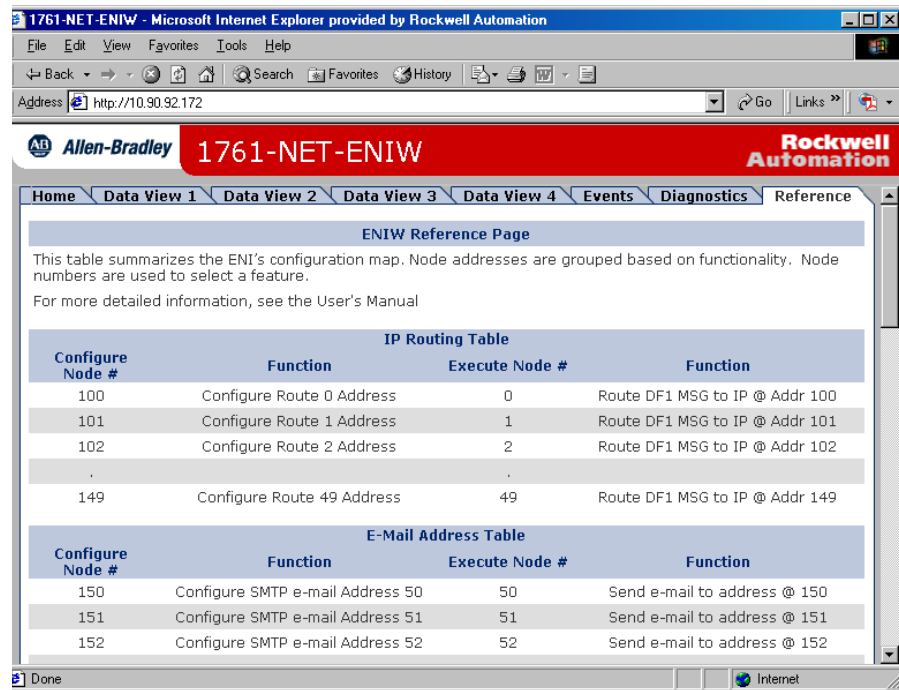

Use the ENIW Utility to Configure the ENIW's Web Server Functionality

The ENI/ENIW Utility includes two tabs for configuring the ENIW's web pages: Web Config and Web Data Desc. These two tabs allow you to title the home page and Data View pages, to enter URL links, and to enter data descriptions for the Data View pages, as described below.

Configure the Home Page

Use the Web Config tab to enter the title of your home page and to customize the last 10 URL links, by entering the title of the link and the URL as show below.

Figure 7.10 Home Page Configuration

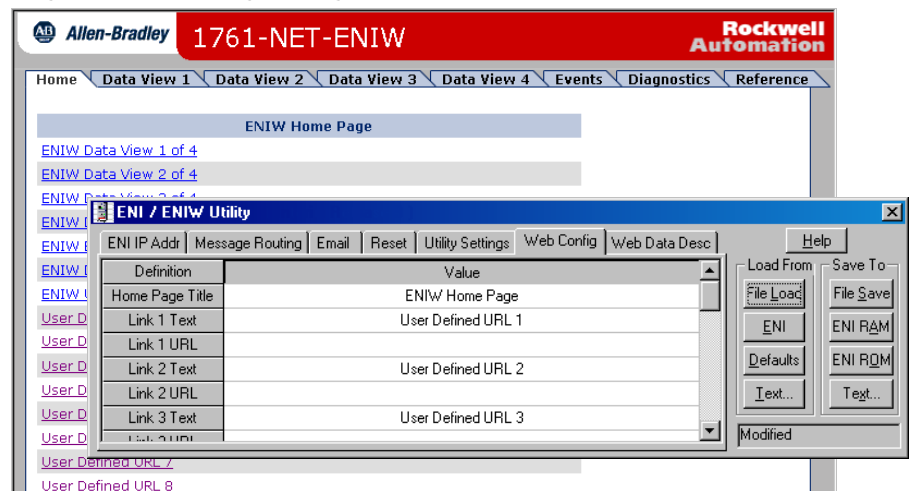

Configure Data View Pages

Use the Web Config tab to enter page titles and passwords, if desired, for the four Data View pages.

Figure 7.11 Enter Data View Page Titles and Set Passwords

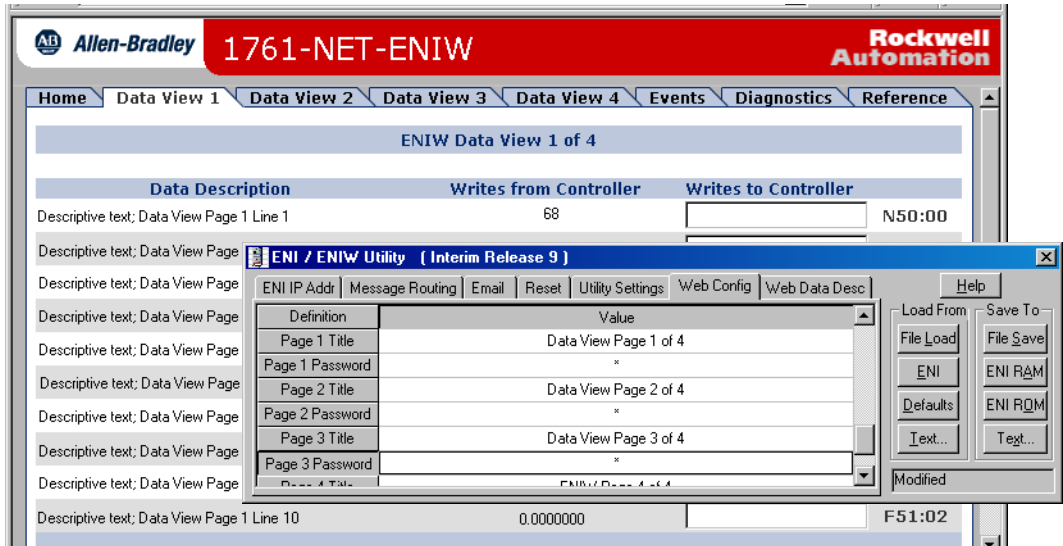

The Web Data Desc tab allows you to enter data descriptions for the ten rows/lines of data on each of the four Data View pages. Descriptions can be 45 characters in length.

Figure 7.12 Enter Web Data Descriptions

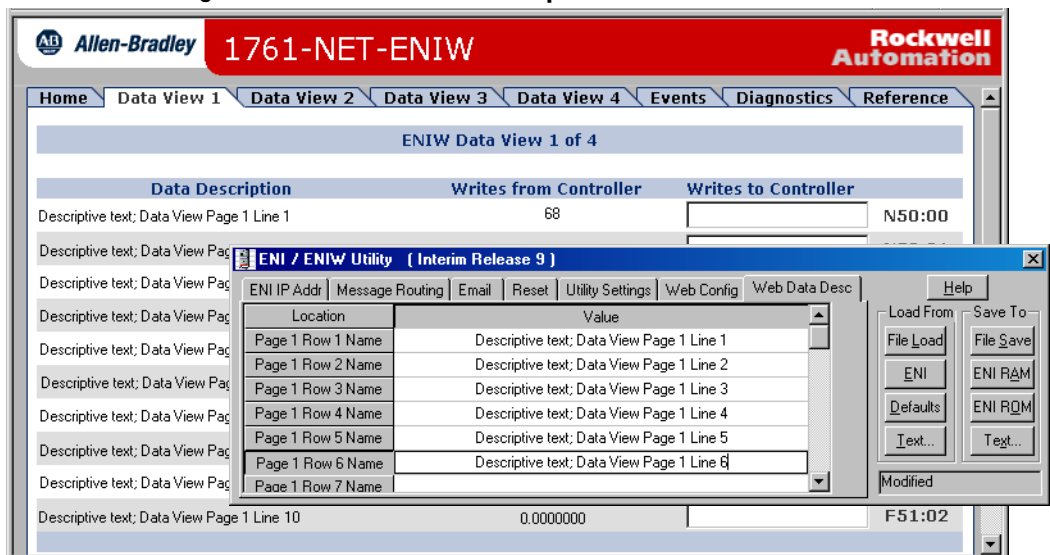

Connecting CompactLogix Controllers on Ethernet

The chapter contains an example of using the ENI/ENIW on an Ethernet network. It is arranged as follows:

- System Diagram
- Purpose
- Scope
- General CompactLogix Messaging Guidelines
- Configure ENI #1
- Configure ENI #2
- Download To The CompactLogix Controller Through Two Series A ENIs
- Download to the CompactLogix Controller Through a ENI/ENIW Series B/C/D via Ethernet
- Create MSG Programs for the SLC 5/05 and the ControlLogix Controllers

System Diagram

Figure 8.1 Example ENI/ENIW Network

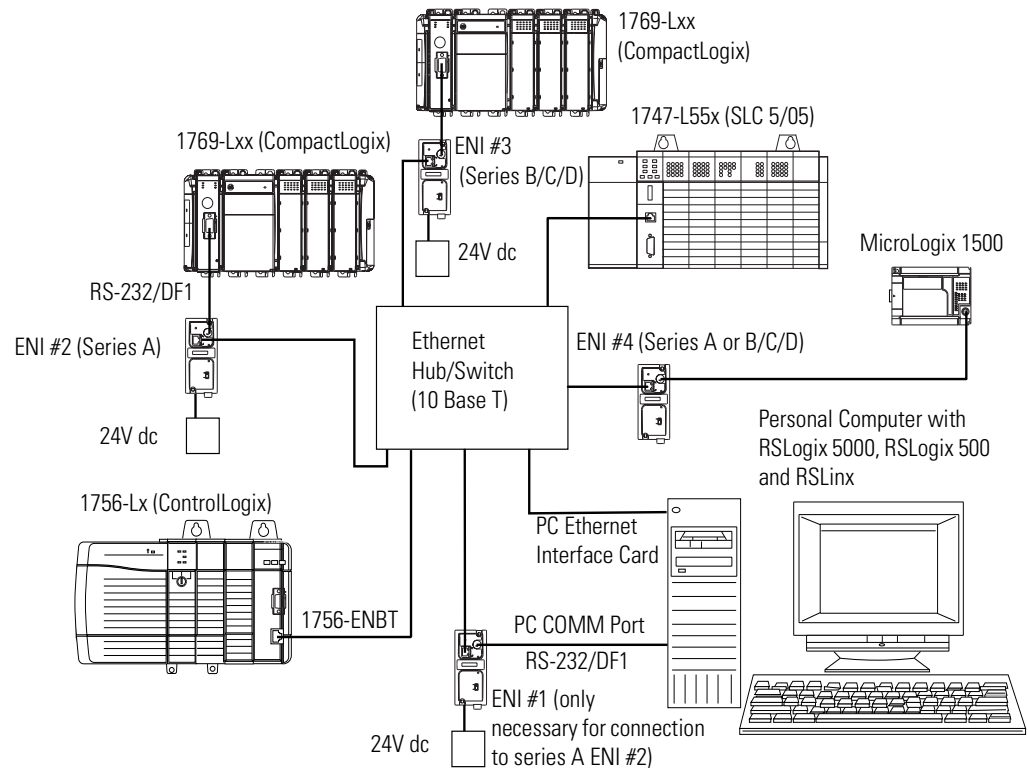

The computer must include the following software:

- RSLogix5000
- RSLinx, version 2.31.00 or later
- RSLogix500
- ENI/ENIW Configuration Utility

The Ethernet Interface Card in the computer is used to connect directly to the SLC 5/05 controller (channel 1), to the ControlLogix controller via the 1756-ENBT card, and to the CompactLogix controller via a series B/C/D ENI/ENIW. Alternatively, the computer's COMM Port can be used to connect to the CompactLogix controller via two ENI/ENIW modules.

IMPORTANT

If the CompactLogix controller is connected to a ENI series A, then you must connect a second ENI/ENIW to your PC's RS-232 port (as shown in the example network on page 8-2) in order to go online with it using RSLogix 5000. If the CompactLogix controller is connected via a ENI/ENIW series B/C/D, then you may go online with it using RSLogix 5000 through the PC's Ethernet card.

Purpose

Provide Ethernet connectivity for CompactLogix controllers via the RS-232 serial port and the ENI/ENIW module.

Scope

Connecting CompactLogix controllers on Ethernet requires one ENI/ENIW per CompactLogix controller. The ENI/ENIW converts RS-232 hardware connections and DF1 full-duplex protocol to Ethernet hardware connections and EtherNet/IP protocol.

The ENI/ENIW must be configured with IP addresses assigned to node numbers 0 to 49. The Destination Node Address in DF1 messages is then used by the ENI/ENIW to route the message to the proper device on Ethernet.

This application example shows how to configure the ENI/ENIW module and how to send messages from the CompactLogix controller to the other controllers on Ethernet. This example also shows how to initiate messages from the Ethernet controllers to the CompactLogix controller. Messages sent to the ENI/ENIW module's IP address will be delivered to the serial port of the CompactLogix controller.

TIP

In the ENI/ENIW, node addresses 45 through 49 are dedicated for sending messages to any Logix controllers with integral Ethernet ports. In addition, when sending messages to a ControlLogix controller via a 1756-ENBT, the controller **MUST** be in slot 0 of the ControlLogix chassis for the message to be delivered to it.

Node addresses 0 through 44 are to be used for all other Ethernet devices, such as other MicroLogix controllers connected to ENI/ENIW modules or other controllers with integral Ethernet ports, such as SLC 5/05, PLC-5E, and MicroLogix 1100.

For this example, we will assign the following IP addresses to the devices on Ethernet:

Table 8.1 Example IP Addresses for Ethernet Devices

Device	Node Address (for L20 MSG)	IP Address
SLC-5/05	1	131.200.50.92
1756-ENBT	45	131.200.50.93
1761-NET-ENI #2	N/A	131.200.50.94
1761-NET-ENI #1	N/A	131.200.50.95
Computer Ethernet Card	N/A	131.200.50.96

IMPORTANT

The IP addresses in Table 8.1 were arbitrarily assigned for this example and should only be used on an isolated Ethernet network as in this example. Contact your system administrator for unique IP addresses if you are connecting your Ethernet devices to your company's Ethernet network.

General CompactLogix Messaging Guidelines

Rungs 0 and 1, shown in Figure 8.2, of the CompactLogix controller's ladder program show an example of throttling two message (MSG) instructions. In this case, sending a MSG to the SLC 5/05, and then when it's complete (Done bit set), initiating a MSG to the 1756-ENBT/ControlLogix controller and so on. The two MSG instructions toggle, with only one outstanding MSG at a time.

This is recommended for the CompactLogix controller to keep the amount of user memory needed for incoming and outgoing messages to a minimum. Each message requires approximately 1.1K bytes of user memory, allocated when the message is to be sent or received. If two messages were enabled at the same time, 2.2K bytes of user memory would need to be available.

Figure 8.2 Throttling Message Instructions

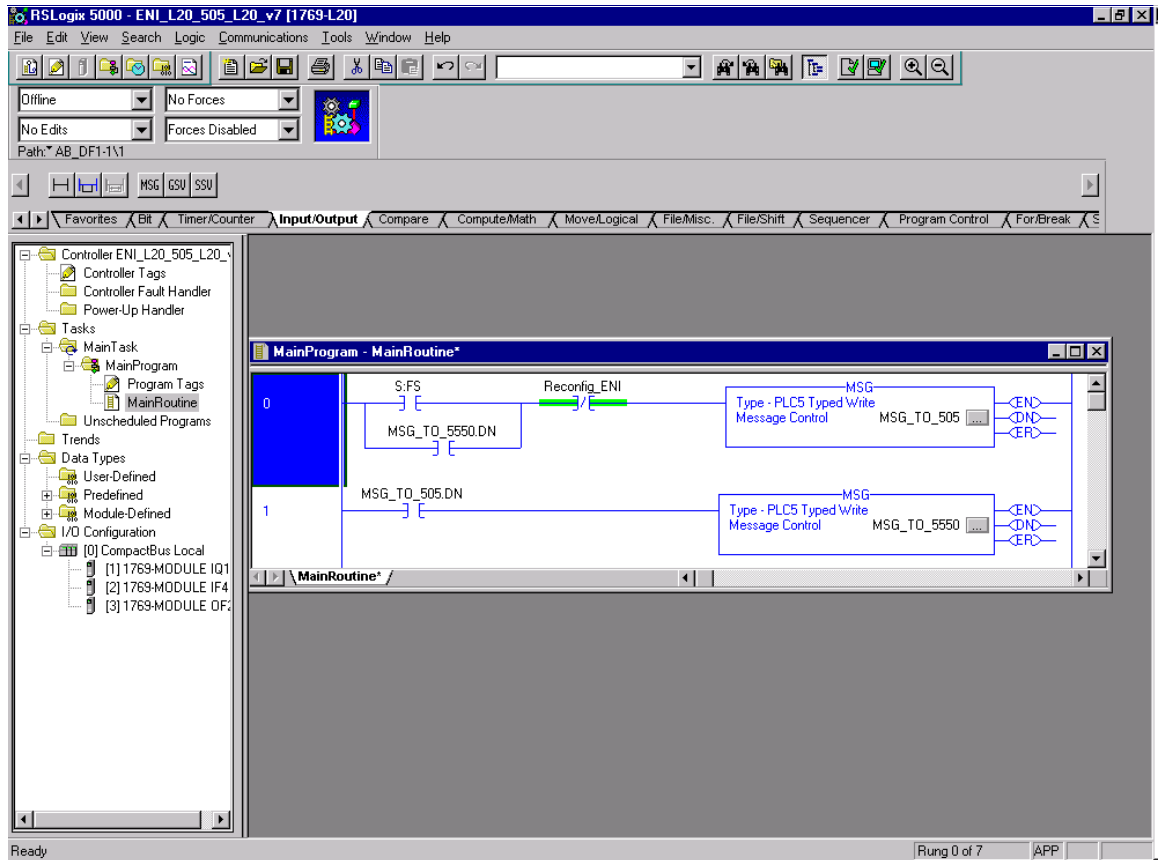

Configure ENI #1

The ENI/ENIW Configuration Utility, free software designed for configuring the 1761-NET-ENI/1761-NET-ENIW, is available for download from www.ab.com/micrologix.

TIP

If the CompactLogix controller is connected to a series B/C/D ENI/ENIW and your computer has an Ethernet network connection, you may skip directly to Configure ENI #2 on page 8-7.

First, configure the ENI/ENIW module connected to the computer. This is ENI #1 per Figure 8.1. A 1761-CBL-PM02 serial cable is used to connect a computer serial communication port to the RS-232 mini-DIN serial port on the ENI/ENIW. The ENI/ENIW Configuration Utility is

used to configure this ENI/ENIW. When you start the ENI/ENIW Configuration Utility, the following screen appears:

Figure 8.3 ENI/ENIW Configuration Utility ENI IP Addr Screen

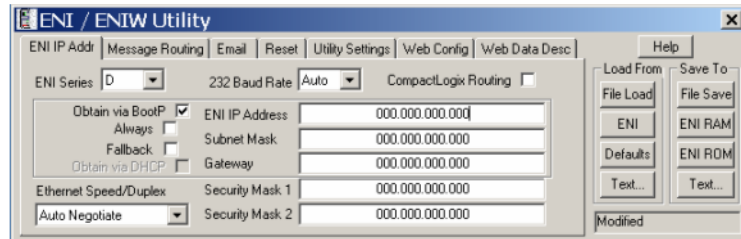

For this example, we use 38400 baud on all serial connections. We also assign IP addresses to all Ethernet products rather than using BOOTP.

IMPORTANT

The ENI series listed on the ENI IP Addr tab determines which fields are available to modify. If you attempt to save a higher series configuration to a lower series ENI, the save will fail. However, a lower series configuration can be saved to a higher series ENI.

The “ENI IP Addr” tab and the “Message Routing” tab in the ENI/ENIW Configuration Utility must be modified for the purposes of this example. The IP address for the ENI/ENIW connected to the CompactLogix controller (ENI #2) is the only address we need to add to the ENI #1 Message Routing table. The other two Ethernet devices are accessed by the computer via the computer’s Ethernet card. Set up the two ENI #1 tabs as follows:

Figure 8.4 ENI #1 Configuration - ENI IP Addr Screen

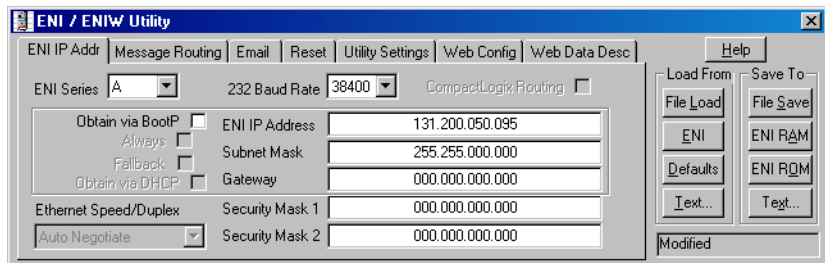
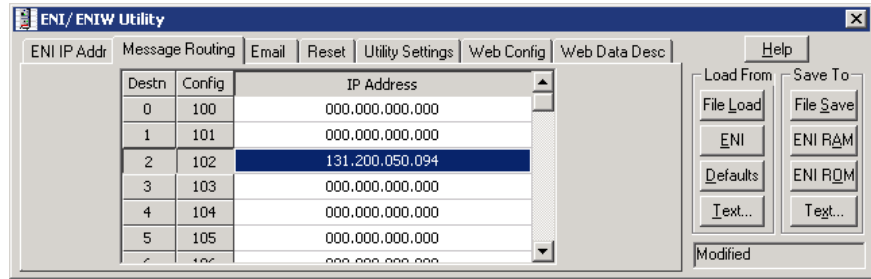
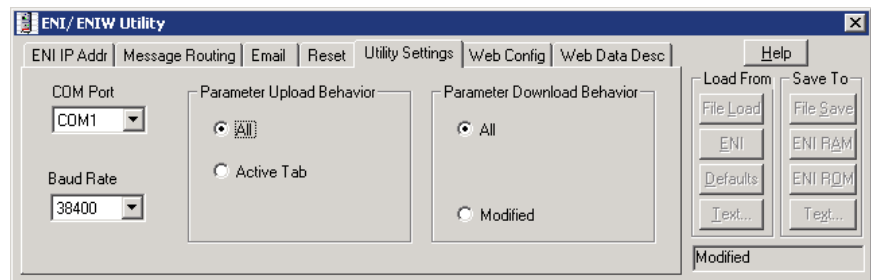

Figure 8.5 ENI #1 Configuration - Message Routing Screen

Before we download our configuration to ENI #1, we must configure the “Utility Settings” tab in the ENI/ENIW Configuration Utility. Choose the following settings.

Figure 8.6 ENI #1 Configuration - Utility Settings Screen

Then, connect the serial cable between your computer and ENI #1 and click on the ENI IP Addr tab. From this tab, under the “Save To” column, click the ENI ROM button. This downloads your configuration parameters to ENI #1 and saves it to non-volatile memory.

Configure ENI #2

ENI #2 is connected to the CompactLogix controller. This ENI/ENIW must be configured with its own IP address (131.200.50.94 for this example) and we must add the IP addresses of the SLC 5/05 controller and the 1756-ENBT/ControlLogix controller to its Message Routing table. The Message Routing table allows for up to 50 IP addresses to

be linked to DF1 destination node addresses, for the following purposes:

Table 8.2 Message Routing

Nodes	Function
0 to 44	Use when sending messages to any Ethernet device, other than Logix controllers with integral Ethernet ports, that supports the same command set as the CompactLogix controller, i.e. SLC 5/05, PLC-5E and other ENI/ENIW modules. We will use the PLC-5 Typed Write commands for this example. CIP commands are not supported by the ENI/ENIW.
45 to 49	Use when sending messages to Logix controllers with integral Ethernet ports. When sending to a ControlLogix Controller via a 1756-ENBT, the controller MUST be in slot 0 of the ControlLogix chassis for the message to be delivered to it.

At this point we need to configure ENI #2 as we did ENI #1, using the ENI/ENIW Configuration Utility.

You could also use the method outlined in Chapter 5 to configure ENI #2. This method sends configuration Messages from the CompactLogix controller via the DF1 link. If for any reason this ENI/ENIW would need to be replaced, it could then be easily and quickly configured via messages from the CompactLogix controller. A ladder program to accomplish this is shown on page 8-10.

Configure ENI #2 Via the ENI/ENIW Configuration Utility

When you start the ENI/ENIW Configuration Utility, the following screen appears:

Figure 8.7 ENI/ENIW Configuration Utility ENI IP Addr Screen

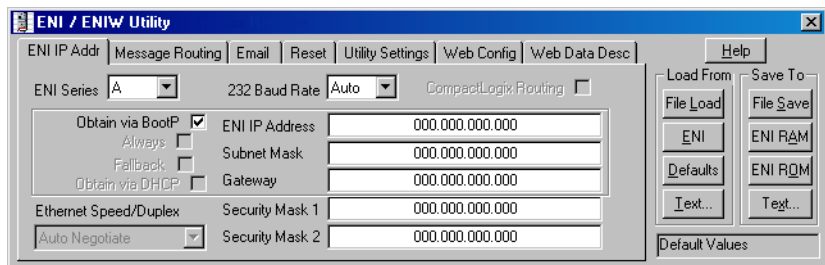

For this example, we use 38400 baud on all serial connections. The “232 Baud Rate” field on the “ENI IP Addr tab” must be left at “Auto” for the series B/C/D ENI/ENIW to detect that a CompactLogix controller is attached to it, and that it should use bridged mode, allowing RSLogix 5000 to upload/download/go online with the CompactLogix from Ethernet. We also assign IP addresses to all Ethernet products rather than using BOOTP.

The “ENI IP Addr” tab and the “Message Routing” tab in the ENI/ENIW Configuration Utility must be modified for the purposes of this example. We need to add the addresses of the SLC 5/05 and the 1756-ENBT to the ENI #2 Message Routing table. These addresses are taken from Table 3.1 on page 3-2. Set up the two ENI #2 tabs as follows:

Figure 8.8 ENI #2 Configuration - ENI IP Addr Screen

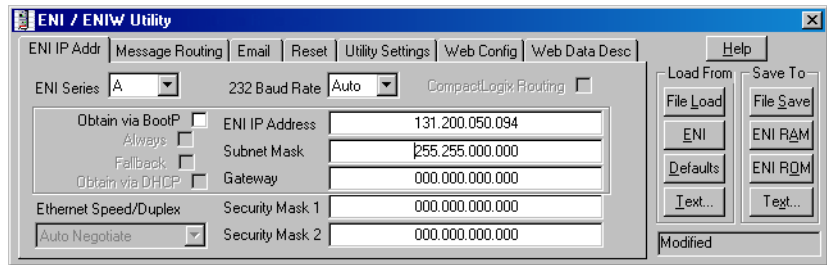
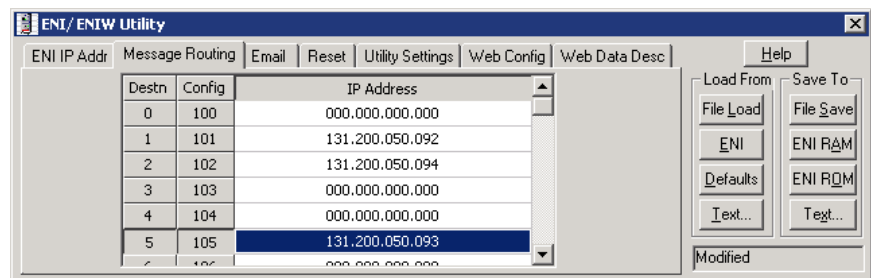
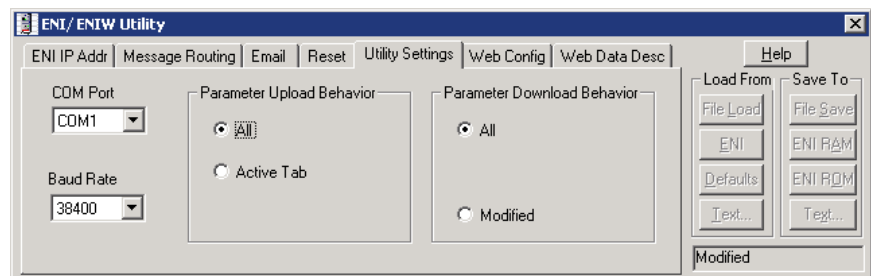

Figure 8.9 ENI #2 Configuration - Message Routing Screen



Before we download our configuration to ENI #2, we must configure the “Utility Settings” tab in the ENI/ENIW Configuration Utility. Choose the following settings.

Figure 8.10 ENI #2 Configuration - Utility Settings Screen



Then, connect the serial cable between your computer and ENI #2 and click on the ENI IP Addr tab. From this tab, under the “Save To” column, click the ENI ROM button. This downloads your configuration parameters to ENI #2 and saves it to non-volatile memory.

Configuration Via Ladder Logic

Rungs 2 through 8, on page 8-10, and the rungs 0 and 1 shown on page 8-5 in this application example, make up the ladder program for the CompactLogix controller. Details of each MSG instruction follow.

Figure 8.11 ENI #2 Configuration - RSLogix 5000 Ladder Program

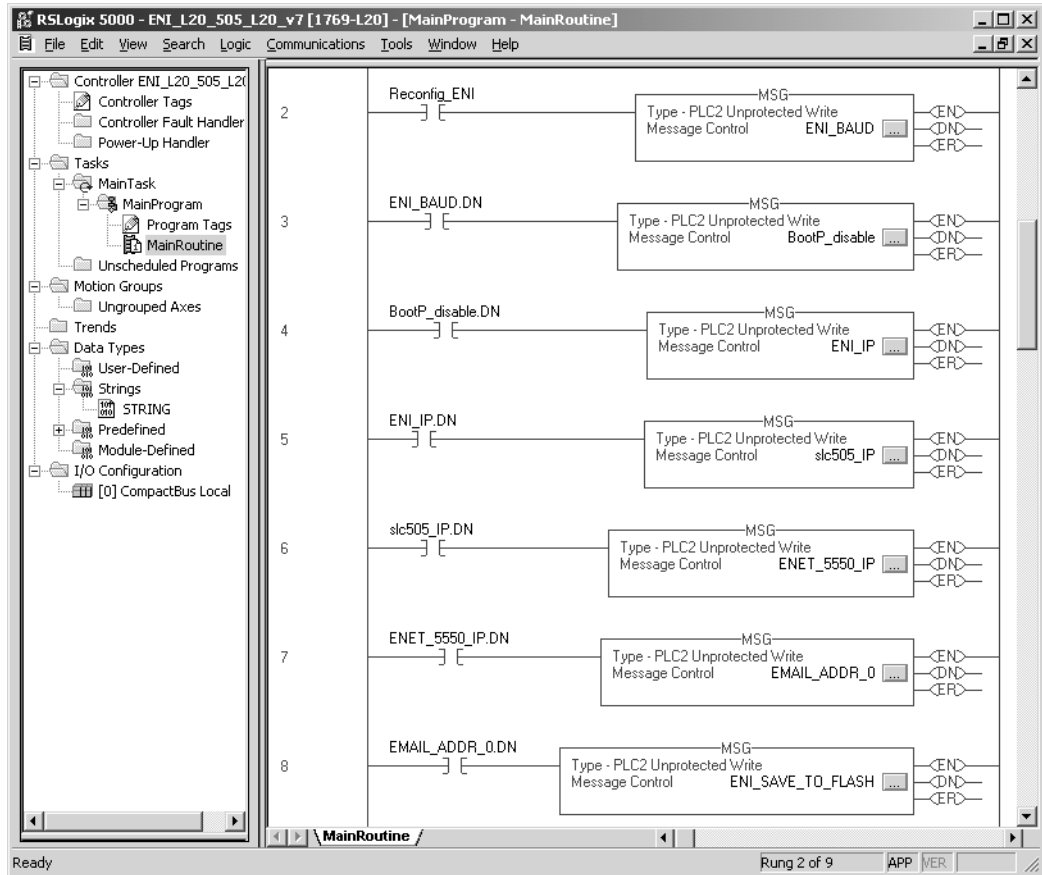

In the above program, Rung 2 initiates the string of configuration messages with input instruction 'Reconfig_ENI'. This could be an alias to an input connected to a pushbutton for example, for quick configuration of the ENI/ENIW module.

In an actual user application, additional logic should be included to handle MSG error conditions (not shown in Figure 8.11).

The 7 rungs used to configure ENI #2 are defined as follows:

Table 8.3 ENI #2 Configuration - Rung Descriptions

Rung	Function
2	This rung initiates the process and configures the ENI/ENIW module's Serial port for bridge mode at 38400 Baud.
3	This rung is initiated by the Done bit of the previous MSG and it disables BOOTP.
4	This rung configures the ENI/ENIW with its own IP address.
5	This rung adds the IP address of the SLC 5/05 controller to the ENI/ENIW module's Message Routing table at DF1 node 1. This means that any message sent by the CompactLogix controller with a DF1 destination address of 1, will be sent to the SLC 5/05 controller on Ethernet.
6	This rung adds the IP address of the 1756-ENBT module to the ENI/ENIW module's Message Routing table at DF1 node 45. This means that any message sent by the CompactLogix controller with a DF1 destination address of 45, will be sent to the 5550 controller in slot 0, via the 1756-ENBT module on Ethernet.
7	This rung adds an email address to the ENI/ENIW module's email routing table at DF1 node 50. This means that any email message sent by the CompactLogix controller with a DF1 destination address of 50 will be sent to this email address.
8	This rung instructs the ENI/ENIW module to save the configuration data sent to it in non-volatile memory.

The following table contains the information needed to send messages to the ENI/ENIW to configure it for this example. For a complete list of ENI/ENIW configurable features, please refer to Chapters 4 and 5.

Table 8.4 ENI #2 Configuration - Message Instructions Parameters

Configuration Node Number	Configuration Function	Data Type	Message Node Number	Message Length (bytes)	Message Function
101	Configure Route 1 Address	Integers	1	8	Route DF1 MSG to IP at Address 1
145	Configure Route 45 Address	Integers	45	8	Route DF1 MSG to IP at Address 2
150	Configure Email Address	Integers ⁽¹⁾ Strings ⁽²⁾	50	84 5 to 49 ⁽²⁾	Route email message to Address 50
248	Save/Reset	Integer	N/A	2	0 = save configuration to flash
250	TCP/IP Config.	Integer	N/A	8	Assign an IP Address to the ENI/ENIW
252	BOOTP	Integer	N/A	2	1 = disable BOOTP/DHCP
253	Baud Rate	Integer	N/A	2	106 = bridge mode at 38400 Baud

(1) First integer must contain the number of characters (45 maximum) in the email address. The second integer contains the first two ASCII characters of the email address. The third integer contains the next two ASCII characters, and so on, until the complete email address has been entered. All remaining integers in the integer array must be zero.

(2) For ENI/ENIW series B FRN 2.20 or higher, you may use a string variable of length 5 bytes (for 1 character) to 49 bytes (for 45 characters). The first 4 bytes of a CompactLogix string element contains the number of characters in the string (1 to 45).

The Message Instructions for the CompactLogix controller, Rungs 2 through 8, used to configure the ENI/ENIW module, must be “PLC2 Unprotected Write” Message Type. The “Destination Element” can be any valid PLC2 command value. “010” is used in this example because it is the first available value that the software will allow. This parameter is not used by the ENI/ENIW, but must be a valid value for RSLogix 5000 to accept it.

An example of the MSG Configuration tab and the Communication tab for the MSG instruction used to configure the IP address for the ENI/ENIW (Rung 4) are as follows:

Figure 8.12 ENI #2 Configuration - Message Configuration Tab

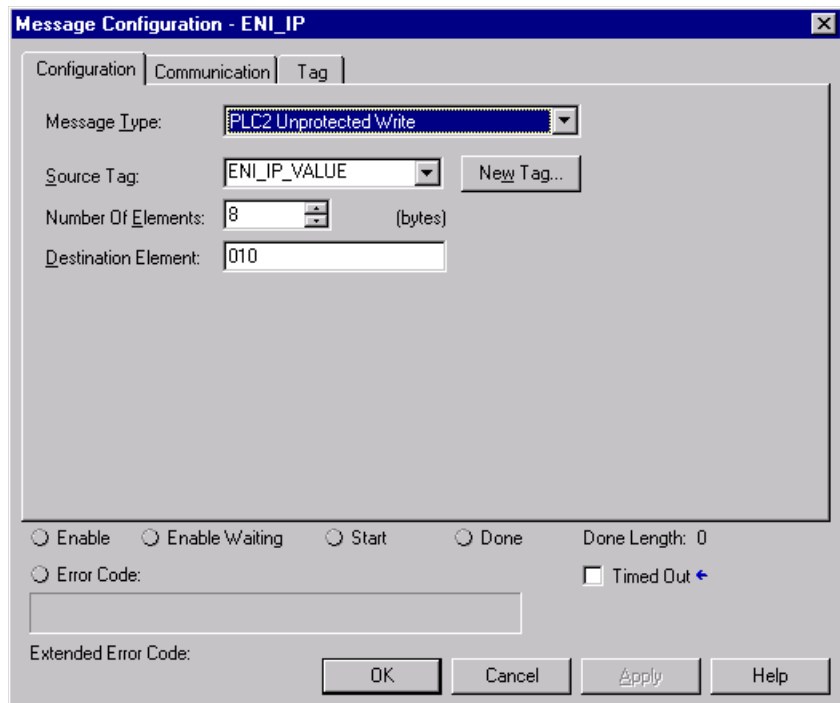
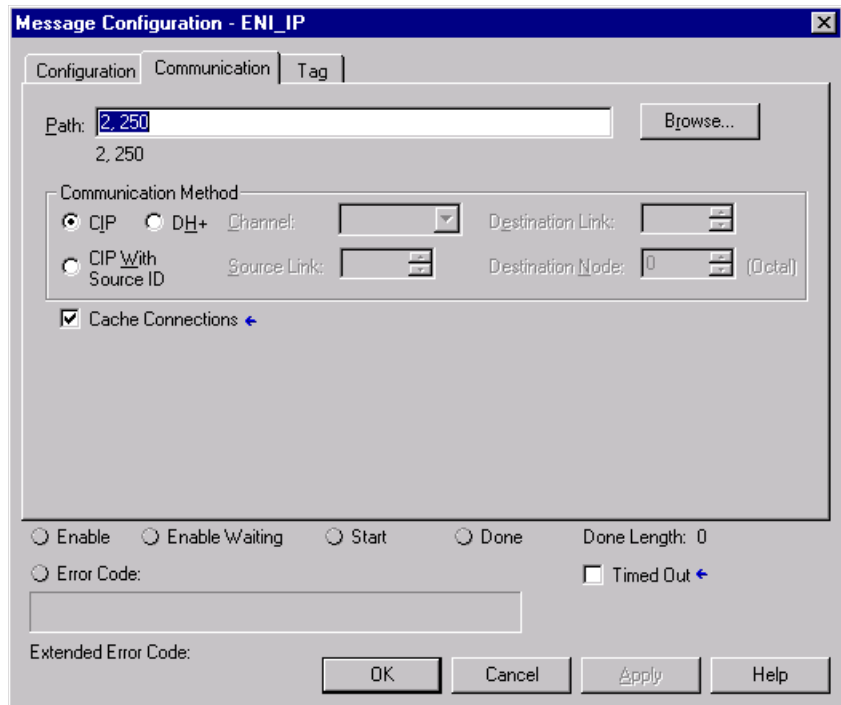

Figure 8.13 ENI #2 Configuration - Message Communication Tab



The MSG length is 8 bytes or 4 integer words. These 4 words contain the IP address for ENI #2 and are stored in tag ENI_IP_VALUE, which is a tag address containing 4 integer words. This is shown in the CompactLogix controller's tag database shown below. On the MSG Instruction's Communication tab above, the path is "2,250", where the 2 represents the CompactLogix controller's serial port and the 250 tells the ENI/ENIW module that the 4 words of data contain its IP address.

TIP

The 2 in the Path shown in the screen above (2, 250) directs the MSG to Channel 0 of the CompactLogix controller. Use 3 for Channel 1 of the CompactLogix 1769-L3x controller.

Figure 8.14 CompactLogix5320 Controller's Tags

Tag Name	Value	Force Mask	Style	Type
BootP_disable	{...}	{...}		MESSAGE
BootP_disable_value	1		Decimal	INT
ENET_5550_IP	{...}	{...}		MESSAGE
ENET_5550_IP_VALUE	{...}	{...}	Decimal	INT[4]
ENET_5550_IP_VALUE[0]	131		Decimal	INT
ENET_5550_IP_VALUE[1]	200		Decimal	INT
ENET_5550_IP_VALUE[2]	50		Decimal	INT
ENET_5550_IP_VALUE[3]	93		Decimal	INT
ENI_BAUD	{...}	{...}		MESSAGE
ENI_BAUD_VALUE	106		Decimal	INT
ENI_IP	{...}	{...}		MESSAGE
ENI_IP_VALUE	{...}	{...}	Decimal	INT[4]
ENI_IP_VALUE[0]	131		Decimal	INT
ENI_IP_VALUE[1]	200		Decimal	INT
ENI_IP_VALUE[2]	50		Decimal	INT
ENI_IP_VALUE[3]	94		Decimal	INT
ENI_SAVE_TO_FLASH	{...}	{...}		MESSAGE
ENI_SAVE_TO_FLASH_VALUE	0		Decimal	INT
slc505_IP	{...}	{...}		MESSAGE
slc505_IP_VALUE	{...}	{...}	Decimal	INT[4]
slc505_IP_VALUE[0]	131		Decimal	INT
slc505_IP_VALUE[1]	200		Decimal	INT
slc505_IP_VALUE[2]	50		Decimal	INT
slc505_IP_VALUE[3]	92		Decimal	INT

As indicated in Table 8.4, the MSGs in Rungs 2, 3 and 8 are 2 bytes or 1 integer word in length. Their Paths are '2,253', '2,252' and '2,248' respectively; where 253 represents Baud Rate, 252 represents BOOTP Enable/Disable, and 248 represents the Save function.

The single integer data value for these messages is shown in Table 8.4. "0" is the value for the Save MSG data tag (ENI_SAVE_TO_FLASH_VALUE), which instructs the ENI/ENIW to save its configuration to non-volatile memory. "106" is the value for the Baud Rate MSG data tag (ENI_BAUD_VALUE) which instructs the ENI/ENIW to begin communicating on its RS-232 port at 38400 Baud. "1" is the value to disable BOOTP (BootP_disable_value).

As shown in Table 8.4, the MSGs in Rungs 5 and 6 assign IP addresses to node numbers in the ENI/ENIW module's Message Routing Table. These two MSG Instructions are the same as the MSG Instruction in Rung 3, except the paths are 2,101 and 2,145 and the data tags have different names; this time containing the IP addresses of the SLC 5/05 (101) and 1756-ENBT module (145).

The MSG in Rung 7, shown in Table 8.4, configures an email address into node 50 of the email table, using a path of 2, 150. For the ENI prior to series B FRN 2.20, the ASCII email address is encoded into an integer array tag of size 42 (INT[41]) as follows:

1. In element 0 of the integer array, enter the number of ASCII characters in the new email address.
2. Change the radix of element 1 to ASCII.
3. Type in the first two ASCII characters of the email address in single quotes.
4. Change the radix of the next element to ASCII.
5. Type in the next two ASCII characters of the email address in single quotes.
6. Repeat steps 4 and 5 until the entire email address is entered.

TIP

For an odd number of characters, the last element should look like 'x\$00', where x is the last character in the email address.

7. Leave all remaining elements at zero.

Figure 8.15 Enter an Email Address

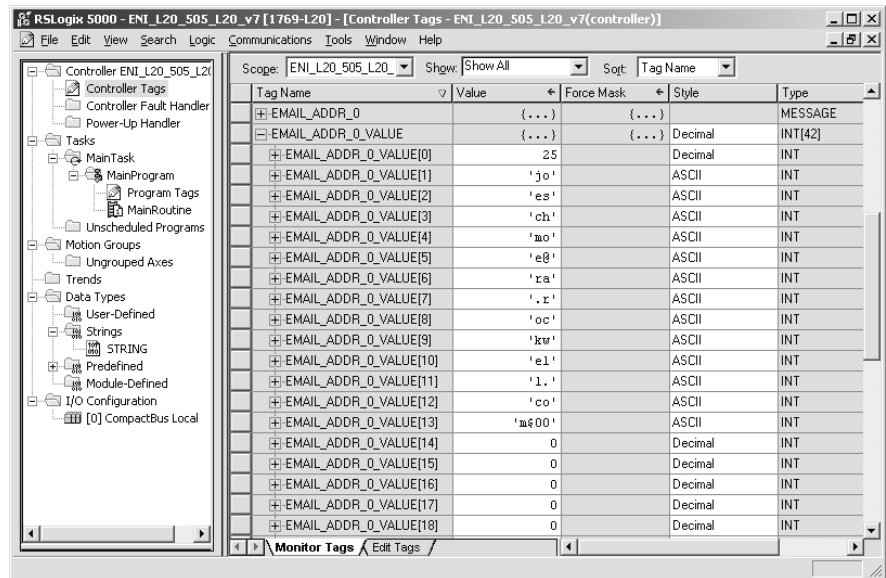

Enter your CompactLogix ladder program per Rungs 0 through 8 as shown and described above. Be sure to enter your IP addresses for ENI #2, the SLC 5/05, and the 1756-ENBT into the proper tags in the controller's tag database. Before saving your program, enter the

Controller Properties window by clicking on the Edit pull-down menu and select Controller Properties. Click on the System Protocol tab and change Error Detection from BCC to CRC and the Baud Rate from 19200 to 38400. Click APPLY, then OK. If you fix the baud rate in the ENI/ENIW, it assumes CRC error detection.

If you do not change this parameter in your CompactLogix controller, it will not be able to communicate with the ENI/ENIW. The Baud Rate of 38400 is being used to increase the upload/download speed.

Finally, since Logix controllers do not use the structured data table addressing scheme used by PLC and SLC controllers, we must map file numbers used in the commands sent to any Logix controller to tag names within them. For example, a MSG sent by an SLC 5/05 controller to the CompactLogix controller uses a PLC-5 Typed Write command. The target data table address used is N12:0. This file 12 must be mapped to a valid tag name in the CompactLogix. Since the MSG is 20 integer words in length, a tag in the CompactLogix controller called “Data_From_505” was created as a 20 integer word tag.

While offline in the CompactLogix controller project, click on the Logic pull-down menu and select “Map PLC/SLC Messages”. The following screen appears:

Figure 8.16 File Mapping in RSLogix 5000

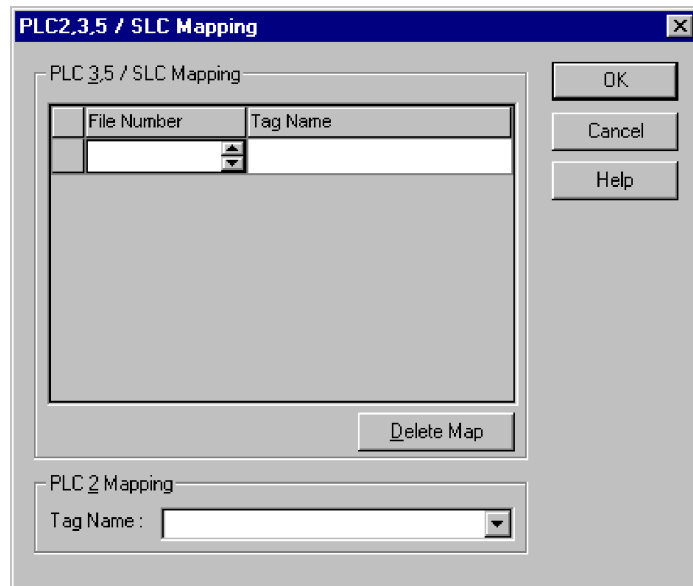

In the File Number column, enter 12. Under the Tag Name, click on the right side in the white box to reveal your Controller Tags and select the tag name you created for this purpose (“Data_From_505” for this example). More than one entry may be mapped. When finished,

your Map PLC/SLC screen for the CompactLogix controller should look like the following:

Figure 8.17 File Mapping for the CompactLogix Controller in RSLogix 5000

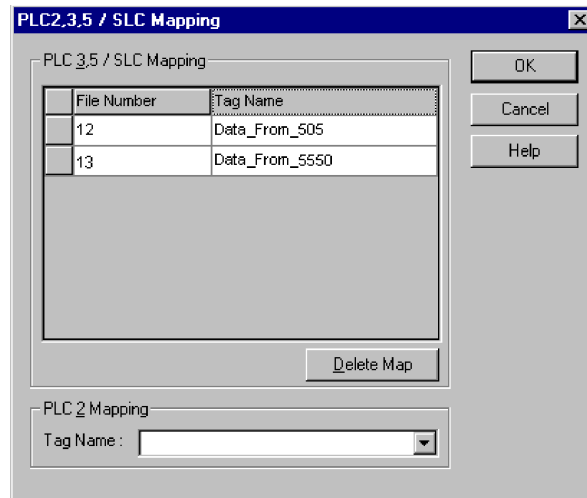

Save your program.

Download To The CompactLogix Controller Through Two Series A ENIs

The ladder program written for the CompactLogix controller can be downloaded to the controller via the two ENI modules. A full-duplex DF1 driver must be configured in RSLinx to initiate the download through ENI #1.

1. Open RSLinx.
2. Open the configure drivers dialog box.
3. Select RS-232 DF1 devices. Click Add New.

- Configure AB_DF1-1 driver to match the example below.



- Click OK when the AB_DF1-1 driver is configured.
- If you have set up the ENI Message Routing table with IP addresses in entries between 1 and 31, those devices should respond when you browse the AB_DF1 driver.

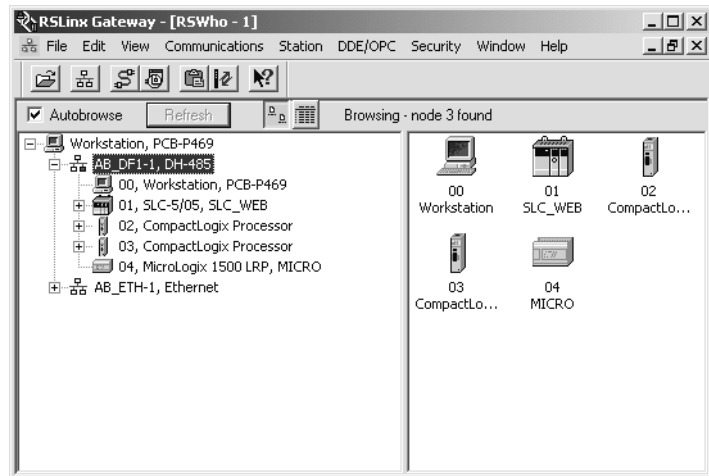

Start RSLogix 5000. Open the CompactLogix program created earlier. Click on the Communications pull-down menu and select Who Active. From the Who Active screen. Click on the + sign left of “AB_DF1-1, DF1”. The CompactLogix controller should appear. Single-click on it to highlight it, then click Download. Your program should download to the controller. You should be online with the controller when the download is complete.

Download to the CompactLogix Controller Through a ENI/ENIW Series B/C/D via Ethernet

In order to download your programs to the CompactLogix controller directly through the ENI/ENIW series B/C/D to the SLC 5/05 controller and to the ControlLogix controller via Ethernet, you must configure an Ethernet driver in RSLinx.

IMPORTANT

You must use RSLinx version 2.31.00 or newer to browse with the 1761-NET-ENI/1761-NET-ENIW series B/C/D via Ethernet to a CompactLogix controller.

Follow these steps to configure RSLinx for Ethernet operation.

1. Open RSLinx and open the driver configuration dialog.

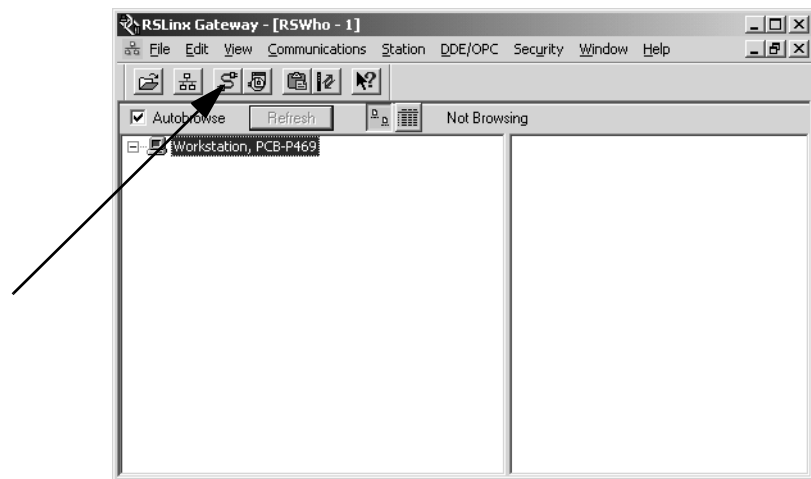

2. The “Configure Dialog” will open, select Ethernet devices from the available drivers, and then click “OK” to load the driver into RSLinx.

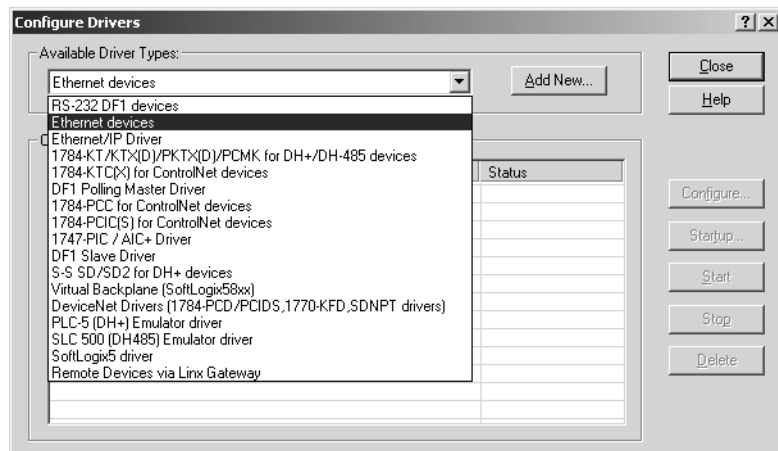

Once the Ethernet driver is loaded, either highlight and select “Configure” or simply double click on the Ethernet driver.

- Click “OK” to accept the default driver name.

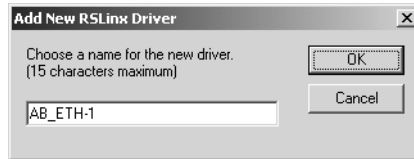

At that point the station mapping screen will appear as illustrated here. Double click on the row below “**Host Name**”, and enter the TCP/IP addresses that match the devices on your network that you will need access to.

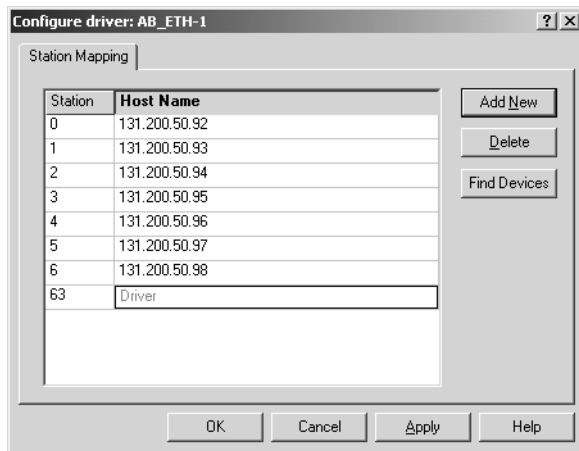
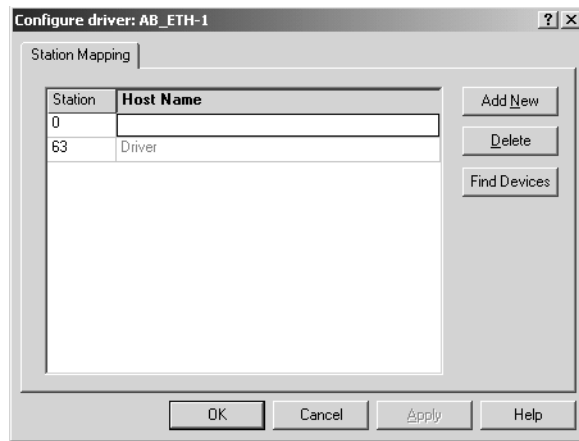

When you are done entering the stations, click OK to close the station mapping window.

- Open the Who Active screen by clicking on the Communications pull-down menu and selecting Who Active.

If your system is properly connected, you should be able to click on the + sign left of the AB_ETH-1 driver you created to establish Ethernet communications with the ENI/ENIW series B,

the 1756-ENET, and the SLC 5/05 controller. The DF1 port is displayed underneath the ENI/ENIW series B/C/D. Clicking on the + sign left of the DF1 port should display the CompactLogix controller.

Close RSWho. Minimize, but do not close, RSLinx.

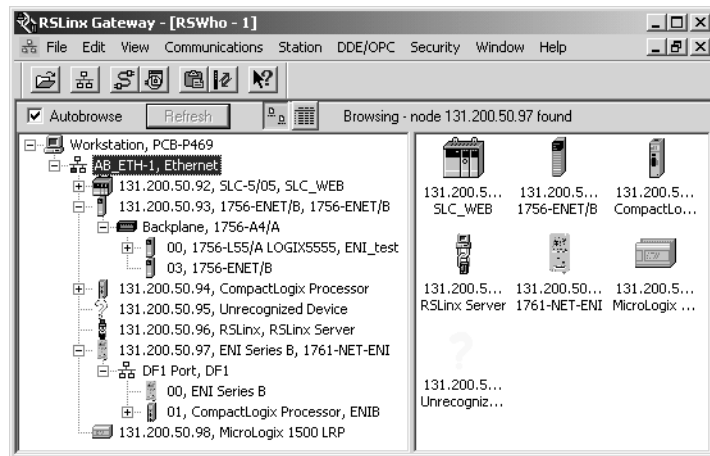

Create MSG Programs for the SLC 5/05 and the ControlLogix Controllers

You must create MSG ladder programs for the other two controllers on Ethernet. The following is the MSG ladder program for the SLC 5/05 controller, developed with RSLogix 500. Following the ladder program are four additional screens showing the two tabs for each MSG Instruction. The first MSG illustrates a typical message to a ControlLogix controller. The second MSG shows how to message to a CompactLogix through a series A ENI. Before saving your program, be sure to configure Channel 1 with its IP address, subnet mask and disable BOOTP. Then, save your program.

Figure 8.18 SLC 5/05 Controller Ladder Program

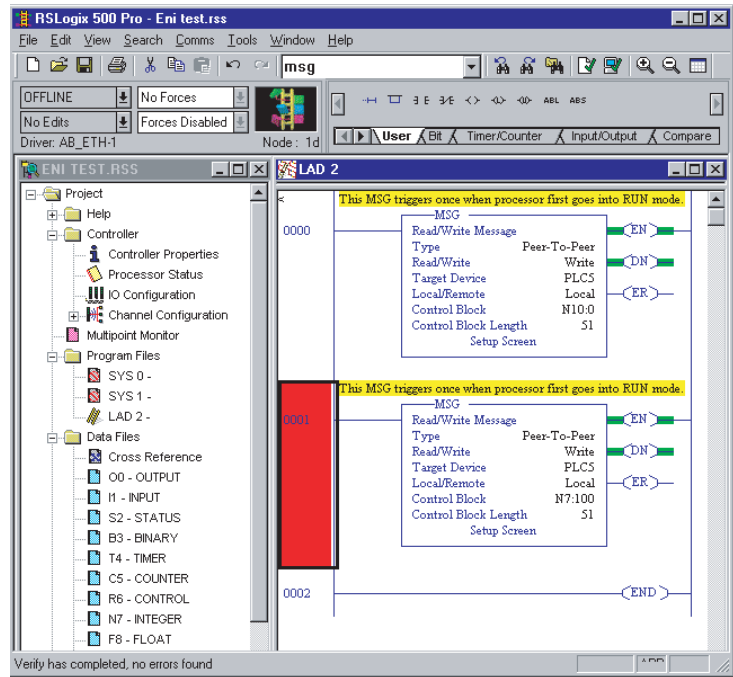

Figure 8.19 SLC 5/05 Rung 0 MSG to ControlLogix via 1756-ENBT

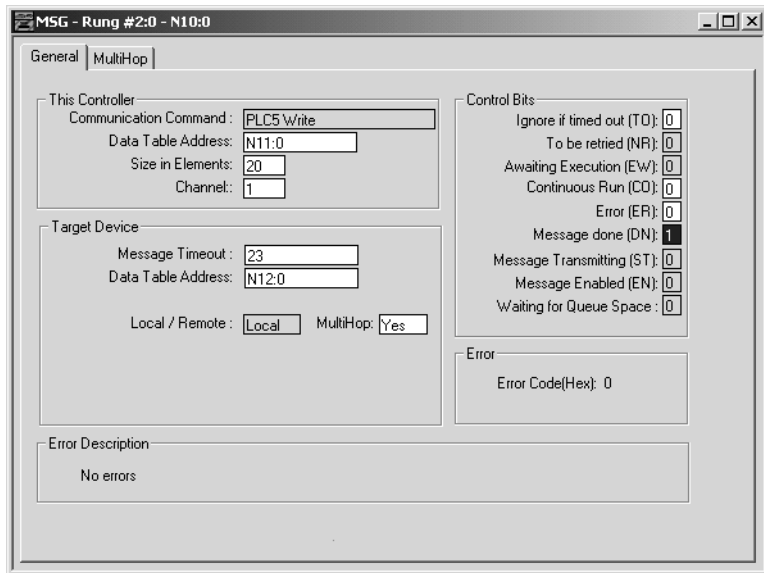

Figure 8.20 SLC 5/05 Rung 0 MSG 'Multihop' Tab

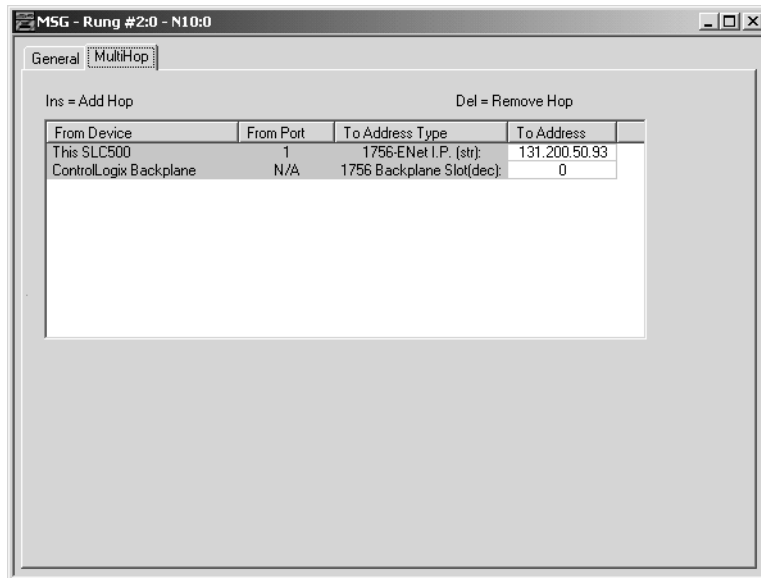

Figure 8.21 SLC 5/05 Rung 1 MSG to CompactLogix via ENI Series A

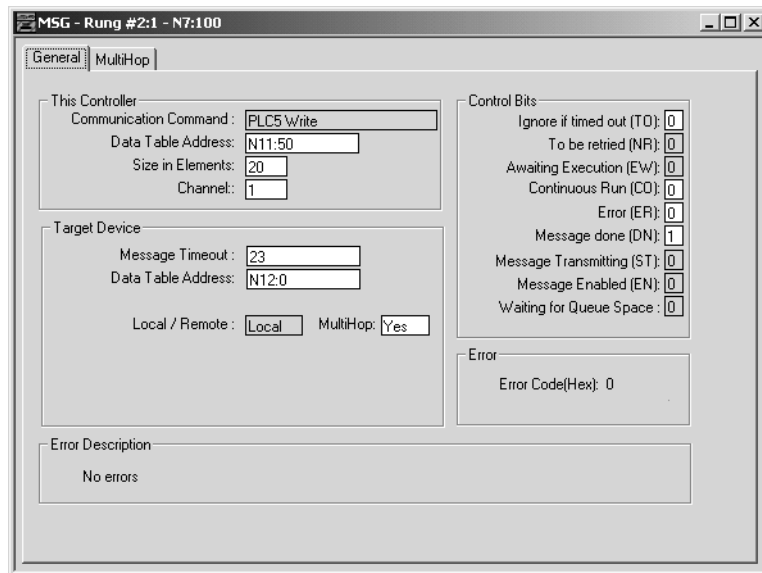

Figure 8.22 SLC 5/05 Rung 1 MSG 'Multihop' Tab

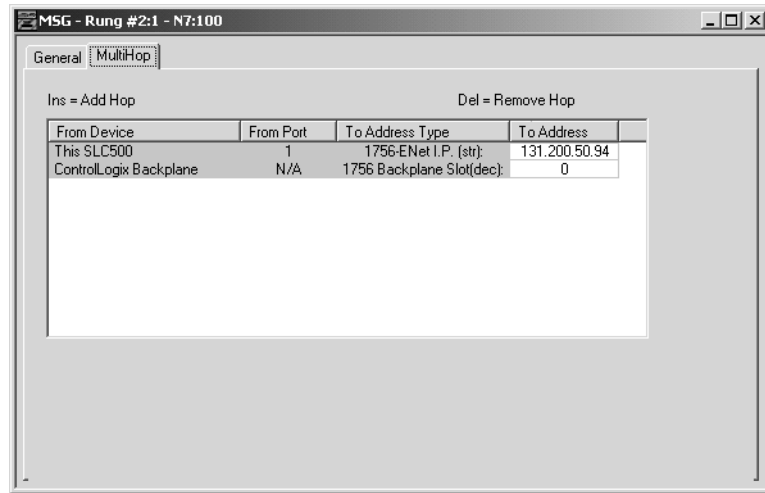

Figure 8.23 on page 8-24 shows the MSG ladder program for the ControlLogix controller, developed with RSLogix 5000. Following the ladder program are six additional screens showing the two tabs for each MSG Instruction. The first MSG illustrates a typical message to an SLC 5/05. The second MSG shows how to message to a CompactLogix via a series A ENI. The third MSG instruction highlights the new functionality of a ENI/ENIW series B/C/D connected to a CompactLogix controller to support the native CIP read and write commands initiated by the ControlLogix controller. As part of your program, you must configure your 1756-ENBT module with the proper IP address.

Figure 8.23 ControlLogix Controller Ladder Program

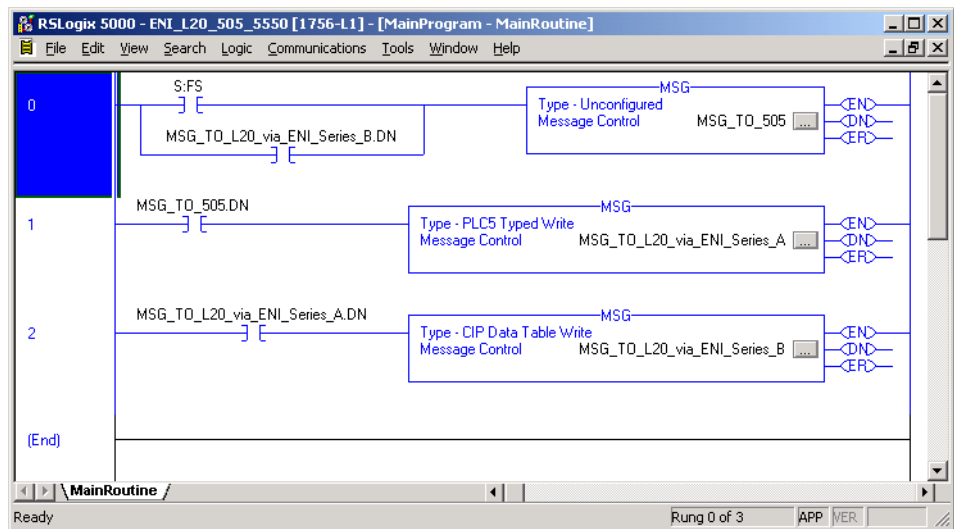

Figure 8.24 ControlLogix Controller Rung 0 Message Configuration Tab

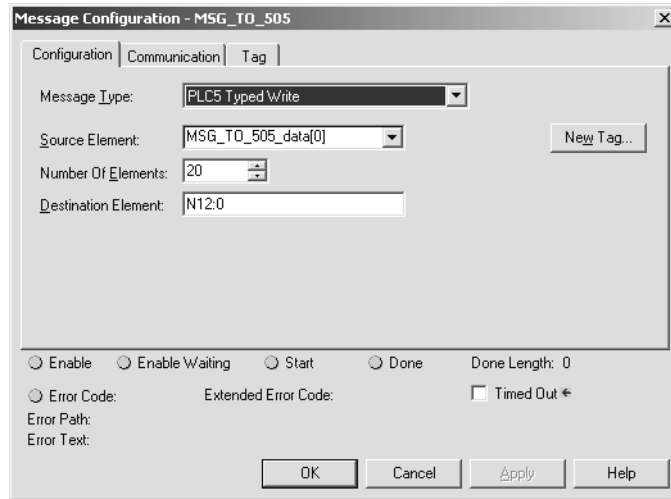

Figure 8.25 ControlLogix Controller Rung 0 Message Communication Tab

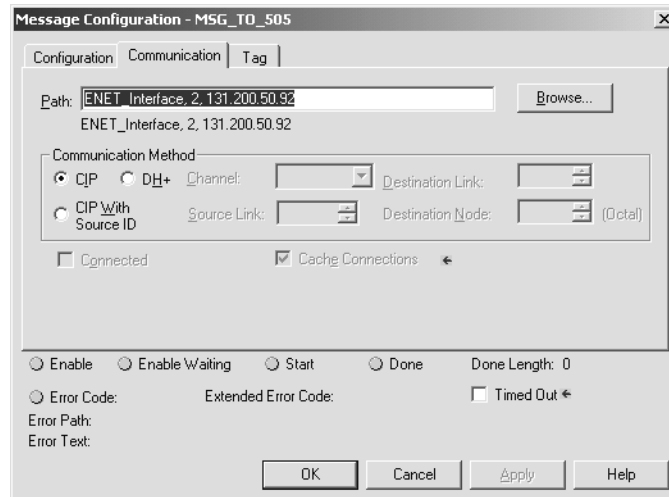

Figure 8.26 ControlLogix Controller Rung 1 Message Configuration Tab

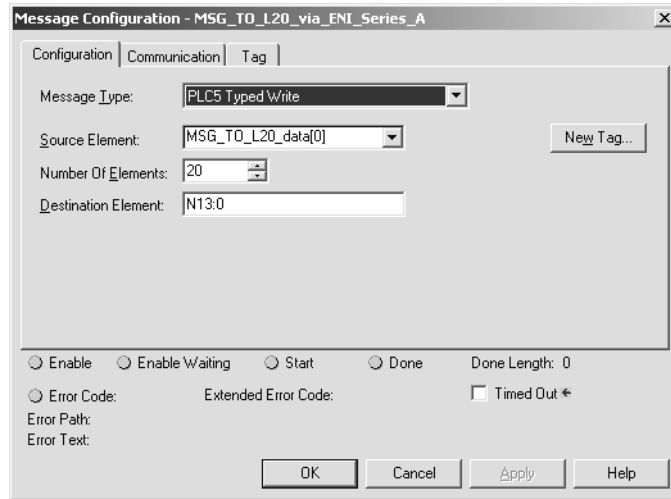

Figure 8.27 ControlLogix Controller Rung 1 Message Communication Tab

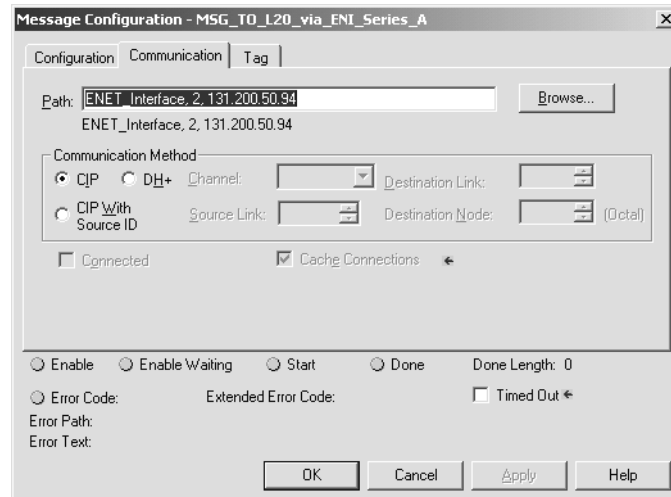
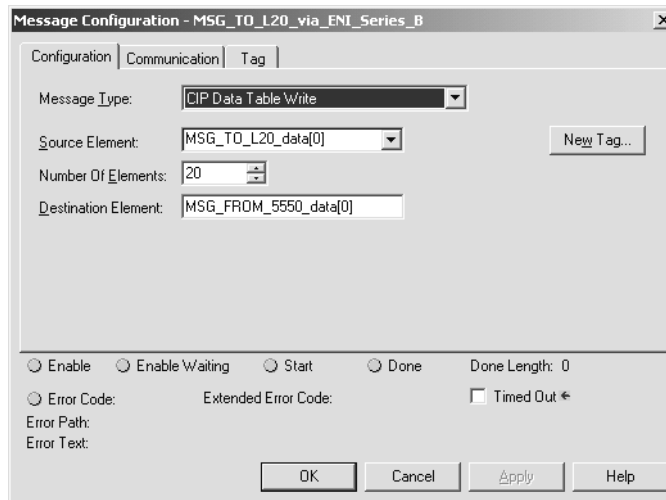
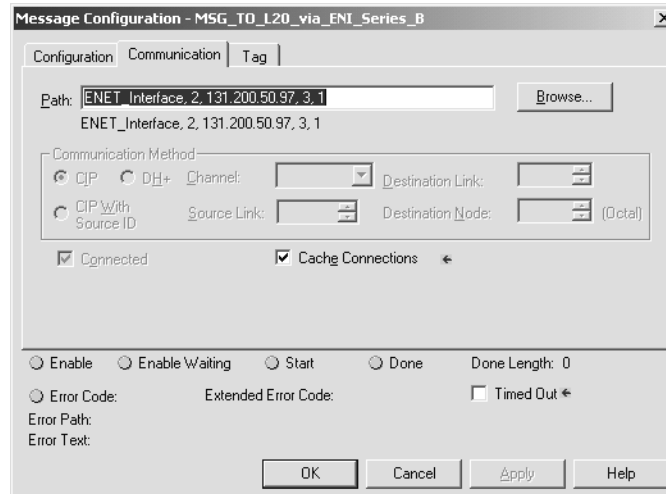
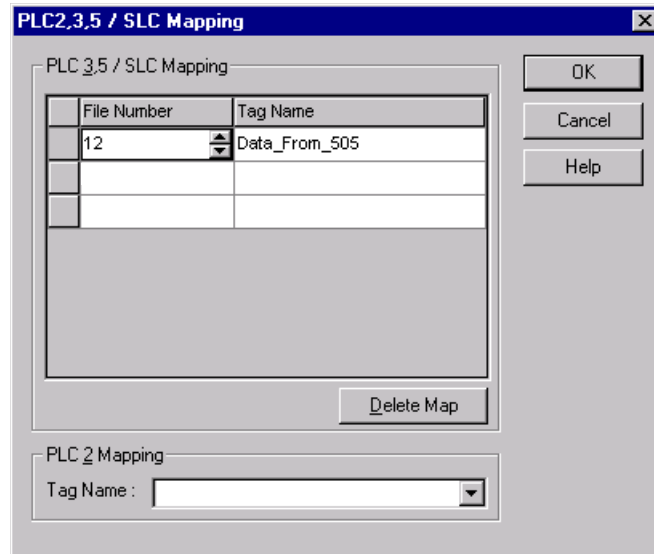

Figure 8.28 ControlLogix Controller Rung 2 Message Configuration Tab**Figure 8.29 ControlLogix Controller Rung 2 Message Communication Tab**

Where PLC_5 Typed Write commands are used, they require a PLC-5 type address to send the data to the receiving controller. Such addresses do not exist in Logix controllers, so they must be mapped to existing tags in these controllers, as described on page 8-28.

1. From the Logic pull down menu, select “Map PLC/SLC Messages”. Your mapped table for your Logix program should look like the following:

Figure 8.30 File Mapping for the ControlLogix Controller in RSLogix 5000



2. Save your program.
3. From the RSLogix 500 programming software, you should now be able to download your SLC 5/05 program. Then, from the RSLogix 5000 software you should now be able to download your ControlLogix controller program.
4. Once all programs are downloaded to their respective controllers, place each controller into the RUN mode and a MSG from each controller will be sent to each of the other controllers. Each controller will only send one MSG at any given time. Go online with the CompactLogix, SLC 5/05, and ControlLogix controllers to verify the successful completion of their messages.

Troubleshooting

This chapter covers the following Troubleshooting topics:

- Network Troubleshooting
- Using ENI/ENIW with Routers
- LED Sequence at Power-Up
- Troubleshooting Using the LED Indicators
- Error Codes Generated by the ENI/ENIW

Network Troubleshooting

Maintain ENI/ENIW Cable Connections

The UTP (unshielded twisted pair) patch cable on a switch should be labeled and treated as dedicated. Be careful when moving any cables, as port identity may be effected. If you must move the ENI/ENIW to a new port for any reason, power-cycle the ENI/ENIW. The power cycle forces a new ARP (address resolution protocol) request to be sent which should immediately associate the ENI/ENIW's IP address with the port it is connected to.

You should also discourage any field personal from treating the ports of a switch as “all the same”. This helps to prevent any problems with network communications being effected by moving cables.

Using ENI/ENIW with Routers

In order to use the ENI/ENIW with standard Ethernet routers, you must configure the IP address of the router on the local subnet into the ENI/ENIW Gateway field using either the ENI config utility or controller messaging. See Chapter 4 for details.

The target device port or socket number is a required field in the TCP/IP header. When configuring routers, you may need to specify the module port assignment. The CIP inbound port uses 44818. The outbound port assignment varies as the processor makes and breaks connections and binds sockets.

LED Sequence at Power-Up

The following LED test is performed at power-up.

Table 9.1 Series A/B LED Sequence at Power-Up (No Ethernet Connection)

LED	Power-Up Sequence
Ethernet TX/RX, Link and FAULT	1. on solid for 2 seconds
FAULT	2. flashes for 3 seconds
Ethernet TX/RX and FAULT	3. on solid for 1/4 second
RS-232 TX/RX	4. flashes if Baud Rate is configured for Auto (default)
FAULT	5. off, unless an error condition exists (see troubleshooting table on page 9-3)

Table 9.2 Series C LED Sequence at Power-Up (No Ethernet Connection)

LED	Power-Up Sequence
FAULT	1. flashes for 4 seconds
RS-232 TX/RX	2. flashes if Baud Rate is configured for Auto (default)
FAULT	3. off, unless an error condition exists (see troubleshooting table on page 9-4)

Table 9.3 Series D LED Sequence at Power-Up (No Ethernet Connection)

LED	Power-Up Sequence
Ethernet Link	1. flashes green once
Ethernet TX/RX	2. flashes amber, then solid green for 1 second
FAULT	3. flashes for 2 seconds
Ethernet TX/RX	4. flashes amber once
RS-232 TX/RX	5. flashes if Baud Rate is configured for Auto (default)
FAULT	6. off, unless an error condition exists (see troubleshooting table on page 9-5)

Troubleshooting Using the LED Indicators

The ENI/ENIW status LEDs provide a mechanism to determine the current status of the ENI/ENIW if a programming device is not present or available. The LED behavior is described in the following table.

Table 9.4 Series A/B LED Indicators

LED	Description	Color	State	Indicates
RS-232 TX/RX	RS-232 data transmission indicator	green	flashing	data is being transmitted or received over the RS-232 port
			off	no RS-232 traffic
POWER	module power	green	on	module is powered
			off	module may not be powered
LINK	Ethernet link status	green	on	the module detects a valid Ethernet connection
			off	the module does not detect a valid Ethernet connection
Ethernet TX/RX	Ethernet data transmission indicator	green	flashing steady	During normal operation (Fault LED is off) the Ethernet port is transmitting or receiving NetLinx packets. For example, if you use "Ping" or "Telnet", the Ethernet TX/RX LED will not flash. ⁽¹⁾
			flash sequence	When the Fault LED is <i>on steady</i> , the Ethernet TX/RX LED flashes the following error codes: <ul style="list-style-type: none"> • ROM Error - 1 flash, then off • RAM Error - 2 flashes, then off • Net Controller Error - 3 flashes, then off • EEPROM error: 4 flashes, then off • Duplicate IP: 5 flashes, then off When the FAULT LED is <i>flashing</i> , the Ethernet TX/RX LED flashes the following error codes: <ul style="list-style-type: none"> • Faulty Network Connection: 4 flashes, then off • ENI/ENIW Not Configured: 5 flashes, then off • Unspecified Fault: off
			off	no Ethernet traffic
FAULT	fault condition indicator	red	on	lit when a fault condition is present, possible causes <ul style="list-style-type: none"> • ROM Checksum Error • RAM Test Error • Network Controller Error • EEPROM Checksum Error • Duplicate IP (see Ethernet TX/RX LED behavior above for error codes)
			flashing	one of the following: <ul style="list-style-type: none"> • faulty network connection • ENI/ENIW does not have a valid IP address
			off	hardware is functioning normally

(1) Indicates Ethernet network traffic to/from the ENI/ENIW.

Table 9.5 Series C LED Indicators

LED	Description	Color	State	Indicates	
POWER	module power	green	on	The module is powered.	
			off	The module does not have power.	
TX/RX	RS-232 data transmission indicator	green	flashing	Data is being transmitted or received over the RS-232 port.	
			off	No RS-232 traffic.	
10	10-Base-T Ethernet link status and data transmission indicator		off	No link or continuous data activity on 10MB Ethernet.	
			amber	on	10-Base-T half-duplex: Link is good, but there is no data activity.
				flashing	10-Base-T half-duplex: Link is good with sporadic data activity. ⁽¹⁾
			green	on	10-Base-T full-duplex: Link is good, but there is no data activity.
flashing	10-Base-T full-duplex: Link is good with sporadic data activity. ⁽¹⁾				
100	100-Base-T Ethernet link status and data transmission indicator		off	No link or continuous data activity on 100MB Ethernet.	
			amber	on	100-Base-T half-duplex: Link is good, but there is no data activity.
				flashing	100-Base-T half-duplex: Link is good with sporadic data activity. ⁽¹⁾
			green	on	100-Base-T full-duplex: Link is good, but there is no data activity.
flashing	100-Base-T full-duplex: Link is good with sporadic data activity. ⁽¹⁾				
FAULT	fault condition indicator	red	on	lit when a fault condition is present, possible causes <ul style="list-style-type: none"> • Duplicated IP address on network • Network controller error 	
			flashing	one of the following: <ul style="list-style-type: none"> • faulty network connection at power up • ENI/ENIW does not have a valid IP address • No BootP/DHCP response 	
			off	Hardware is functioning normally	

(1) Network activity is not necessarily to/from the ENI/ENIW.

Table 9.6 Series D LED Indicators

LED	Description	Color	State	Indicates	
POWER	module power	green	on	The module is powered.	
			off	The module does not have power.	
RS-232 TX/RX	RS-232 data transmission indicator	green	flashing	Data is being transmitted or received over the RS-232 port.	
			off	No RS-232 traffic.	
LINK	Ethernet activity status and 10-Base-T or 100-Base-T indicator		off	No link or continuous data activity on 10MB Ethernet.	
			amber	on	10-Base-T link is good.
			green	on	100-Base-T link is good.
TX/RX	Ethernet activity status and half-duplex or full-duplex indicator		Off	No activity.	
			amber	flashing	Half-duplex data activity. ⁽¹⁾
			green	flashing	Full-duplex data activity. ⁽¹⁾
FAULT	fault condition indicator	red	on	lit when a fault condition is present, possible causes <ul style="list-style-type: none"> • Duplicated IP address on network • Network controller error 	
			flashing	one of the following: <ul style="list-style-type: none"> • faulty network connection at power up • ENI/ENIW does not have a saved IP address (uses default IP address 192.168.1.254) • No BootP/DHCP response 	
			off	Hardware is functioning normally.	

(1) Any Ethernet network activity; not necessarily to/from the ENI/ENIW.

Error Codes Generated by the ENI/ENIW

This table shows the MSG error codes that may be generated by the ENI/ENIW to the connected DF1 device.

Table 9.7 ENI/ENIW-Generated Error Codes

Error Code	Description of Error Condition
10H	Target node cannot respond because of incorrect command parameters or unsupported command. Possible causes: <ul style="list-style-type: none"> • The data size of the message is invalid. • The data format is incorrect for any of the supported PCCC messages. • Register parameters are not formatted correctly, or there is not enough data provided. • RS-232 configuration packet data is not the correct size. • The Node Address is invalid or out-of-range. • The distant ENI/ENIW, controller, or device may not be responding. • There may be a break in the connection between the ENI/ENIW devices or controllers. • BOOTP/DF1 parameter is invalid.
30H	Target node responded with: Remote station host is not there, disconnected, or shutdown.
DOH	One of the following: <ul style="list-style-type: none"> • No IP address configured for the network or ENI/ENIW not configured for Node Address used. • Bad command - unsolicited message error. • Bad address - unsolicited message error. • No privilege - unsolicited message error.

Specifications

Physical Specifications

Description	ENI/ENIW Specification
24V dc Power Source Requirement	20.4 to 26.4V dc
24V dc Current Draw	50 mA typical, 100 mA maximum
Maximum Inrush Current	200 mA
Internal Isolation	710V dc for one minute
Vibration	operating: 10 to 500 Hz, 5.0g, 0.030 in. peak-to-peak, 2 hour each axis
Shock	operating: 30g, ± 3 times each axis non-operating: 35g (DIN Rail Mount) 50g (Panel Mount), ± 3 times each axis
Operating Ambient Temperature	0° C to +60° C (+32° F to +140° F)
Storage Temperature	-40° C to +85° C (-40° F to +185° F)
Humidity	5% to 95% relative humidity (non-condensing)
Agency Certification ⁽¹⁾	<ul style="list-style-type: none"> • UL 1604 • C-UL C22.2 No. 213 • Class I Division 2 Groups A,B,C,D • CE compliant for all applicable directives • C-Tick marked for all applicable acts
<i>Radiated and Conducted Emissions:</i>	<i>EN 50081-2, Class A</i> <i>The module has passed testing at the following levels:</i>
<ul style="list-style-type: none"> • ESD Immunity (EN 61000-4-2) 	<ul style="list-style-type: none"> • 4 kV contact, 8 kV air, 4 kV indirect
<ul style="list-style-type: none"> • Radiated Immunity (EN 61000-4-3) 	<ul style="list-style-type: none"> • 10V/m, 80 to 1000 MHz, 80% amplitude modulation, and 900 MHz keyed carrier
<ul style="list-style-type: none"> • Fast Transient Burst (EN 61000-4-4) 	<ul style="list-style-type: none"> • Power supply: 2 kV, 5 kHz • RS-232 and Ethernet: 1kV, 5 kHz
<ul style="list-style-type: none"> • Surge Immunity (EN 61000-4-5) 	<ul style="list-style-type: none"> • Power Supply: 500V • Ethernet (unshielded cable): 2 kV • RS-232 and Ethernet (shielded cable): 1 kV galvanic gun
<ul style="list-style-type: none"> • Conducted Immunity (EN 61000-4-6) 	<ul style="list-style-type: none"> • Power Supply: 10V, 0.15 to 80 MHz • RS-232 and Ethernet (unshielded cable): 3V, 0.15 to 80 MHz • RS-232 and Ethernet (shielded cable): 10V, 0.15 to 80 MHz

(1) Shielded Ethernet cable required for marine certification.

Series C and D Ethernet Specifications

Communication Rate: Auto-negotiates 10 Mbps, full- or half-duplex and 100 Mbps, full- or half-duplex

Connector: 10/100-Base-T

MicroLogix Web Site

Visit <http://www.ab.com/micrologix> for more information on MicroLogix products. You can find a variety of application information and White Papers covering specific technical topics.

Dimensions

Product Dimensions

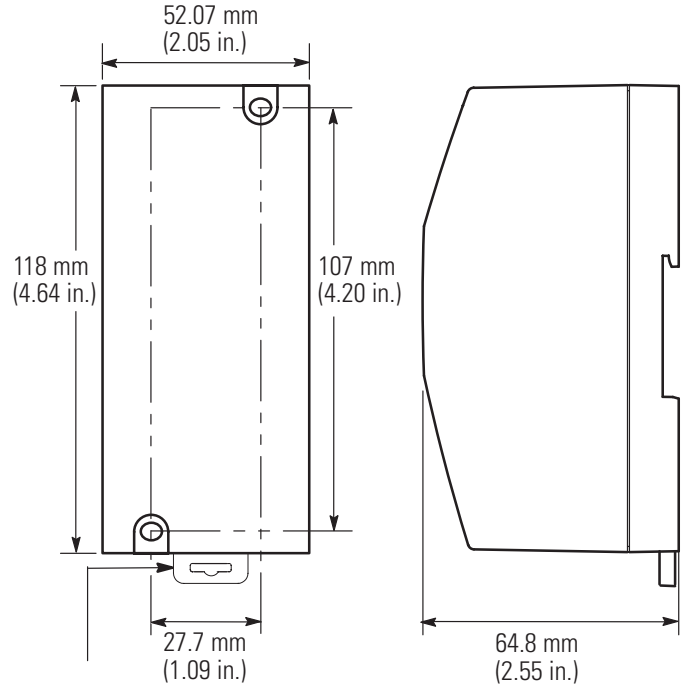

Allow 15 mm (0.6 in.) clearance for DIN rail latch movement during installation and removal.

Mounting Dimensions

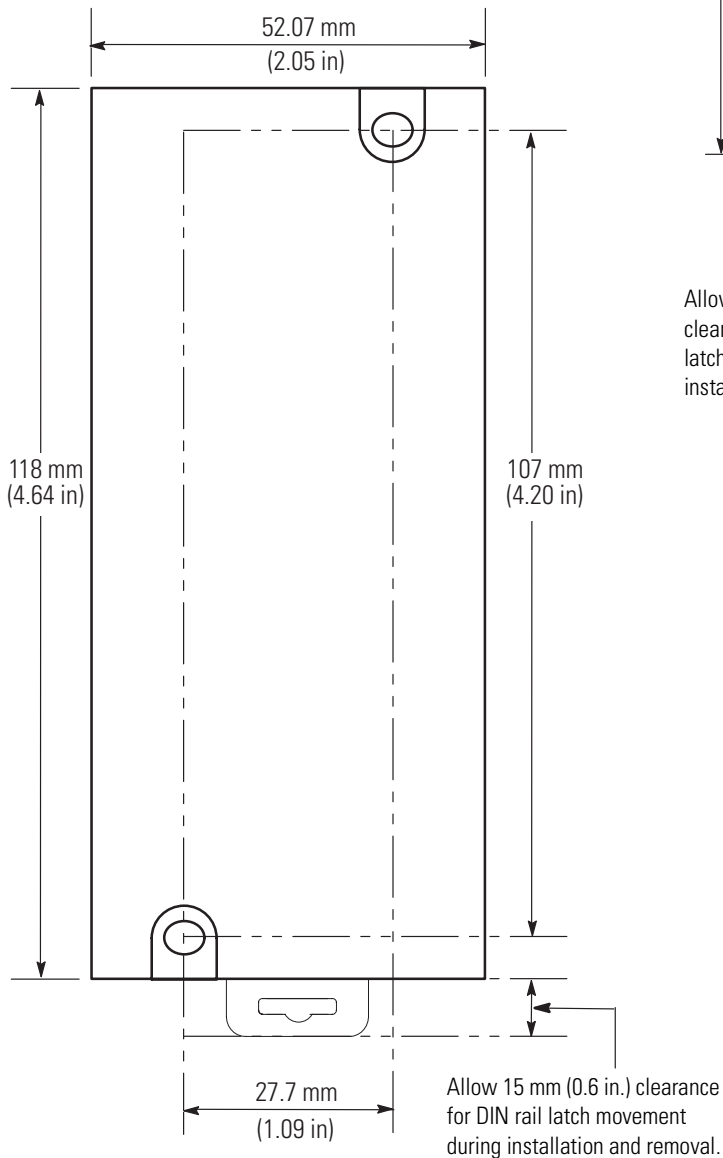

BOOTP Configuration Method (default)

BOOTP (Bootstrap protocol) is a low-level protocol that provides configuration information to other nodes on a TCP/IP network with DOS, Microsoft Windows, Windows NT, Windows 9x, VMS, and HP-UNIX platforms. BOOTP configuration files let you automatically assign IP addresses to the ENI/ENIW. You can also set Subnet Masks and Gateway addresses using BOOTP.

DHCP (Dynamic Host Configuration Protocol) is a newer protocol used for the same purpose as BOOTP. DHCP provides more flexibility in the management of network addresses. DHCP enables individual devices on an IP network to extract their configurations from a server. Specifically, DHCP allows the device to extract this information from a server that has no exact information about the individual devices until they request the information. The overall purpose of DHCP is to reduce the work necessary to administer a large IP network.

To use BOOTP or DHCP, a BOOTP/DHCP Server must exist on the local Ethernet Subnet. The server is a computer that has BOOTP/DHCP Server software installed and running.

TIP

If you do not have BOOTP/DHCP Server capabilities on your network, and you want to dynamically configure the ENI/ENIW, you can download the Rockwell Automation BOOTP/DHCP Utility from www.ab.com/networks/bootp/index.html.

The BOOTP/DHCP Server Utility provides you with an interface from which you can select a module and interactively assign it an IP address. It also allows you to assign an IP address to a device in cases where an installation-wide BOOTP/DHCP server is not being used, or where alternative means of assigning IP addresses are less convenient or not available.

When the ENI/ENIW receives a configuration message via BOOTP, it uses the data within the message to configure its TCP/IP parameters.

Table B.1 TCP/IP Parameters

Function	Format	Notes
IP Address	Integer	This is a unique IP Address for the ENI/ENIW. Format is aaa.bbb.ccc.ddd. Default is 000.000.000.000.
Subnet Mask	optional ⁽¹⁾	If not sent, the default mask is derived from the class of the IP address. See page 4-17 for more information on the subnet mask.
Gateway	optional ⁽¹⁾	Only needed if a Gateway is present on the Subnet. Default is 000.000.000.

(1) Depending upon whether your BOOTP server allows these optional fields to be included, you might not be able to configure these parameters. If that is the case, configure them using the soft configuration method. See page 4-1 for more information. If you do not need to define a Subnet Mask or Gateway, simply ignore these parameters.

ENI/ENIW BOOTP Operation

When BOOTP is enabled, the following events occur at power-up:

- The ENI/ENIW broadcasts a BOOTP-request message containing its hardware address over the local network or subnet.
- The BOOTP server compares the hardware address with the addresses in its look-up table.
- The BOOTP server sends a message back to the ENI/ENIW with the IP address and other network information that corresponds to the hardware address it received.

With all hardware and IP addresses in one location, you can easily change IP addresses in the BOOTP configuration file if your network needs change.

The ENI/ENIW allows the BOOTP request to be disabled by clearing the BOOTP Enable parameter. See Node 252 - BOOTP Configuration on page 4-15.

Using the Rockwell BOOTP/DHCP Utility

The Rockwell BOOTP/DHCP utility is a standalone program that incorporates the functionality of standard BOOTP software with a user-friendly graphical interface. It is located in the **Utils** directory on the **RSLogix 5000** installation CD. It can also be downloaded from www.ab.com/networks/bootp/index.html web page. The device must have BOOTP enabled (factory default) to use the utility.

To configure your device using the BOOTP utility, perform the following steps:

1. Run the BOOTP software. In the **BOOTP Request History** panel you will see the hardware addresses of devices issuing BOOTP requests.

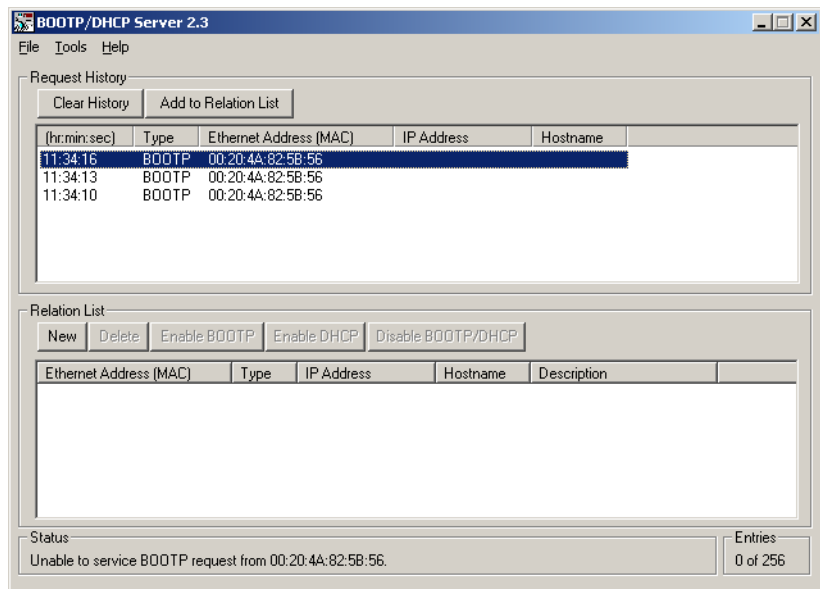

2. Double-click on the hardware address of the device you want to configure. You will see the **New Entry** pop-up window with the device's Ethernet Address (MAC).

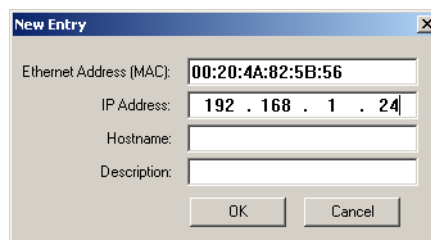

3. Enter the **IP Address**, **Subnet Mask**, and **Gateway** you want to assign to the device, and click on **OK**.

The device will be added to the **Relation List**, displaying the Ethernet Address (MAC) and corresponding IP Address, Subnet Mask, and Gateway (if applicable).

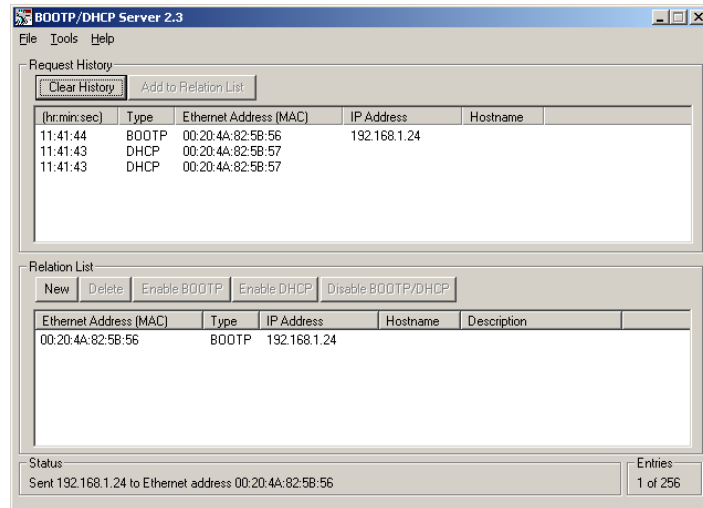

1761-NET-ENI/ENIW Performance Considerations

Ethernet/IP Connections

The ENI/ENIW supports 6 concurrent TCP/IP connections: 2 incoming, 2 outgoing and 2 that can be allocated as incoming or outgoing. Connection use can be viewed on the Diagnostics tab of the ENI/ENIW web page (series D only).

Each TCP/IP connection simultaneously supports up to:

- 4 CIP connections
- 5 Unconnected sends

Packet Size Limitations

Each TCP/IP connection has its own DF1 queue. Each DF1 queue has 10 message buffers. The size of each message buffer is 580 bytes.

Using SLC-type reads, the following array sizes can be read over Ethernet via the ENI/ENIW using the RSLinx OPC Test Client:

- MicroLogix - 248 bytes of data
- SLC 500 - 236 bytes of data
- CompactLogix - 250 bytes of data

These limitations are due to serial port packet size limitations of the respective controllers, not the ENI/ENIW.

Data Throughput

In tests performed using the RSLinx OPC Test Client, the ENI/ENIW (series D) was connected to a MicroLogix 1500 with channel 0 set to 38.4 kbaud. The Ethernet port was connected to the computer through a 10/100 Mbps switch.

Number of Packets	Packet Size (Words)	Packet Rate (packet/s)
1	1	31
2	1	62
3	1	75
4	1	86
5	1	88
6	1	94
7	1	94

The maximum number of minimum-sized packets per second that can be transmitted through the ENI/ENIW (series D) at 100 Mbps to a MicroLogix 1500 at 38.4 kbaud is 94 (94 words/second).

Number of Packets	Packet Size (Words)	Packet Rate (packet/s)
1	100	7
2	100	14
3	100	15
4	100	15

The maximum number of 100-word packets per second that can be transmitted through the ENI/ENIW (series D) at 100 Mbps to a MicroLogix 1500 at 38.4 kbaud is 15 (1500 words/second).

Autobaud

A feature that allows a communications port to automatically synchronize to the device or network that it is attached to. This feature typically minimizes the amount of configuration required, and also makes it easier to replace devices.

Auto BCC/CRC

Sends a test message during autobaud to detect which Error Detecting setting to use, BCC or CRC. This will not occur for fixed baud rate settings. The ENI/ENIW uses CRC for fixed baud rates.

Baud Rate

The speed of communication between devices on a network. All devices must communicate at the same baud rate. Most DF1 devices default to 19,200 baud.

CIP (Common Industrial Protocol)

DHCP (Dynamic Host Configuration Protocol)

DF1 Full-Duplex

DF1 is a standard (open) point-to-point communication protocol. Virtually all Allen-Bradley controllers (Logix, PLC-5, SLC, MicroLogix) that have an RS-232 communications port support DF1.

DF1 Protocol

A peer-to-peer link-layer protocol that combines features of ANSI X3.28-1976 specification subcategories D1 (data transparency) and F1 (two-way simultaneous transmission with embedded responses).

ENI (Ethernet Network Interface)

Allen-Bradley catalog number 1761-NET-ENI and 1761-NET-ENIW. The ENI allows you to connect DF1 devices to Ethernet networks. The ENIW adds web server capabilities.

Ethernet Network

A local area network with a baseband communication rate of 10/100/1000M bits per second.

Full-duplex

A high-performance protocol that allows simultaneous two-way data transmission. For point-to-point applications only.

IP (Internet Protocol)

IP specifies the format of packets and the addressing scheme. Most networks combine IP with a higher-level protocol called Transport Control Protocol (TCP), which establishes a virtual connection between a destination and a source.

IP by itself is something like the postal system. It allows you to address a package and drop it in the system, but there's no direct link between you and the recipient. TCP/IP, on the other hand, establishes a connection between two hosts so that they can send messages back and forth for a period of time.

IP Address

A 32-bit address assigned to hosts that want to participate in a TCP/IP internet. IP addresses are the abstraction of physical hardware addresses, with a network and host partition which makes routing efficient.

NetLinx Services

The NetLinx services occur over the well-known port 0xAF12 and define a connection protocol that exists after a TCP/IP connection is established. It also defines a set of services and packet formats to support the protocol.

Network

A series of stations (nodes) connected by some type of communication medium. A network may be made up of a single link or multiple links.

Node

Also called a station. An address or software location on the network.

MTA (Mail Transfer Agent)

The software function responsible for delivering outgoing mail to its final destination.

PCCC (Programmable Controller Communications Commands)**RS-232**

An EIA standard that specifies electrical, mechanical, and functional characteristics for serial binary communication circuits.

Security Mask

The Security Mask, when configured, allows you to restrict incoming TCP/IP and/or UDP messages to have source IP addresses that are within some prescribed range. For example, if you wanted to restrict all message sources to be from within a company's allocated IP address range, a Security Mask could be configured that would block any IP address outside that range.

SMTP (Simple Mail Transfer Protocol)

This protocol defines the interface and commands with the Mail Transfer Agent and defines how the ENI/ENIW will deliver the outgoing mail.

Single-Hop/ Multi-Hop

Term that refers to how many "different" networks a message must traverse to reach its destination. For the ENI/ENIW, a single-hop message is one whose source and destination nodes are both TCP/IP end points.

TCP (Transmission Control Protocol)

TCP is one of the main protocols in TCP/IP networks. Whereas the IP protocol deals only with packets, TCP enables two hosts to establish a connection and exchange streams of data. TCP guarantees delivery of data and also guarantees that packets will be delivered in the same order in which they were sent.

TCP/IP (Transmission Control Protocol/Internet Protocol)

The suite of communications protocols used to connect hosts on the Internet. TCP/IP uses several protocols, the two main ones being TCP and IP. TCP/IP is built into the UNIX operating system and is used by the Internet, making it the de facto standard for transmitting data over networks.

UCMM (Unconnected Message Manager)

The UCMM is an object defined in the CIP protocol. This object is responsible for handling connection requests and unconnected message traffic.

UTP (Unshielded Twisted Pair)

A type of cable used in Ethernet systems.

A

- Auto BCC/CRC**
 - definition Glossary-1
- Autobaud**
 - CRC with bridge function 4-14
 - definition Glossary-1
 - restrictions 4-14
- Auto-Refresh** 7-9

B

- Baud Rate**
 - configuring 4-14
 - definition Glossary-1
 - with bridge function 4-14
- BOOTP Configuration** 4-15, B-1

C

- Cables** 2-2, 2-6, 2-7
- CE Mark** 2-1
- CIP**
 - definition Glossary-1
- Com Port Redirector**
 - download 4-1, 4-8
 - redirect com port 4-8–4-11
- Common Techniques Used in this Manual** P-2
- Compatibility** 1-7
- Configuration** 4-1
 - BOOTP 4-15
 - controller messaging 4-12
 - e-mail 6-2
 - list of parameters 4-12
 - over Ethernet 4-8–4-11
 - via BOOTP B-1
 - via message instruction 5-2
- Configuration Utility** 4-1
- Connections**
 - allocation of Ethernet connections 3-1
 - Ethernet switch 2-6

D

- data view pages**
 - data table addresses 7-11
 - displaying data 7-5
 - posting data 7-10
- DF1 Full-Duplex**
 - definition Glossary-1
 - messaging 5-1

DF1 Protocol

- default settings 1-5
- definition Glossary-1

DHCP B-1

- configuration 4-15, B-3
- definition Glossary-1

diagnostic page

- example 7-13

diagnostics page 7-12**Dimensions** A-2**E**

- EDS file download** 3-7
 - E-Mail Message Fields** 6-4
 - E-Mail Messages** 6-1
 - E-Mail Server** 4-15
 - E-Mail, sending a message** 6-4
 - EMC Directive** 2-1
 - ENI**
 - configuration 4-1
 - definition Glossary-1
 - functional overview 3-2
 - LED indicators 1-2
 - operating modes 1-7
 - operation 3-1
 - overview 1-1
 - port identification 2-5
 - product drawing 1-2
 - ENI Configuration Utility** 4-1
 - Ethernet Connections** 2-5
 - Ethernet Hardware Address** 4-13
 - Ethernet Network**
 - connections 1-8
 - definition Glossary-1
 - ENI connection 1-1
 - example 8-1
 - Ethernet Port** 1-2
 - event page**
 - displaying data 7-11
 - Example**
 - using the CompactLogix serial port to connect to an Ethernet network 8-1
 - Explosion Hazard** 2-2
-
- F**
 - Fault LED** 1-2, 1-3, 1-4
 - From String** 4-19, 6-2
 - Full-Duplex**
 - definition Glossary-1

G**Grounding** 2-3**H****Hardware Address** 1-2, 4-13**Hardware Features** 1-2**Hazardous Location** 2-2**I****Installation and Wiring** 2-1**Integer Files** 4-22**IP**

definition Glossary-2

IP Address

assigning 1-5

definition Glossary-2

ENI write-on area 1-2

L**LED Indicators** 1-2**LED indicators**

series A/B 1-2

series C 1-3

series D 1-4

LED Sequence at Power-Up 9-2**Link LED** 1-2**Low Voltage Directive** 2-1**M****Manuals, Related** P-2**Memory Map** 3-2**Messaging** 4-12, 5-1**Mounting** 2-3

dimensions A-2

MTA

definition Glossary-2

N**Netlinx Services**

definition Glossary-2

Network

definition Glossary-2

Node

definition Glossary-2

O**Operating Modes** 1-7**Operation** 3-1**P****Password Protection**

disabling device update 7-10

Password-Protection

removing 7-10

PCCC

definition Glossary-2

Peer Connections 3-1**Peer-to-Peer Messaging** 5-1**Posting Data** 7-10**Power LED** 1-2, 1-3, 1-4**Power Supply Wiring** 2-3**Product Overview** 1-1**Publications, Related** P-2**Purpose of this Manual** P-1**R****redirect com port** 4-8–4-11**Reference page** 7-13**Related Publications** P-2**RS-232**

cables 2-7

connector 2-7

default settings 1-5

definition Glossary-2

ENI port 1-2

pin assignments 2-7

RSLinx 3-4**S****Safety Considerations** 2-2**Save/Reset** 4-19**Security Mask** 4-17

definition Glossary-3

series B

features 1-7

series D

features 1-8

Single-Hop

definition Glossary-3

SMTP

definition Glossary-3

SMTP E-Mail Address 6-2**Specifications** A-1

String Files 4-24
Subnet Mask 4-17

T

TCP
definition Glossary-3
TCP/IP
configuration 4-15
definition Glossary-3
Troubleshooting
maintain ENI connections 2-6
procedure 9-1
TX/RX LED (Ethernet) 1-2, 1-4
TX/RX LED (RS-232) 1-2, 1-3, 1-4

U

UCMM
definition Glossary-3
URL links
unused links 7-4
UTP
definition Glossary-3

W

Web Browser Compatibility 7-1
Wiring 2-1

Rockwell Automation Support

Rockwell Automation provides technical information on the web to assist you in using our products. At <http://support.rockwellautomation.com>, you can find technical manuals, a knowledge base of FAQs, technical and application notes, sample code and links to software service packs, and a MySupport feature that you can customize to make the best use of these tools.

For an additional level of technical phone support for installation, configuration and troubleshooting, we offer TechConnect Support programs. For more information, contact your local distributor or Rockwell Automation representative, or visit <http://support.rockwellautomation.com>.

Installation Assistance

If you experience a problem with a hardware module within the first 24 hours of installation, please review the information that's contained in this manual. You can also contact a special Customer Support number for initial help in getting your module up and running:

United States	1.440.646.3223 Monday – Friday, 8am – 5pm EST
Outside United States	Please contact your local Rockwell Automation representative for any technical support issues.

New Product Satisfaction Return

Rockwell tests all of our products to ensure that they are fully operational when shipped from the manufacturing facility. However, if your product is not functioning and needs to be returned:

United States	Contact your distributor. You must provide a Customer Support case number (see phone number above to obtain one) to your distributor in order to complete the return process.
Outside United States	Please contact your local Rockwell Automation representative for return procedure.

Allen-Bradley and MicroLogix are trademarks of Rockwell Automation.
Microsoft is a registered trademark of Microsoft Corporation.
Netscape is a registered trademark of Netscape Communications Corporation.

www.rockwellautomation.com

Power, Control and Information Solutions Headquarters

Americas: Rockwell Automation, 1201 South Second Street, Milwaukee, WI 53204-2496 USA, Tel: (1) 414.382.2000, Fax: (1) 414.382.4444

Europe/Middle East/Africa: Rockwell Automation, Vorstlaan/Boulevard du Souverain 36, 1170 Brussels, Belgium, Tel: (32) 2 663 0600, Fax: (32) 2 663 0640

Asia Pacific: Rockwell Automation, Level 14, Core F, Cyberport 3, 100 Cyberport Road, Hong Kong, Tel: (852) 2887 4788, Fax: (852) 2508 1846

Publication 1761-UM006E-EN-P - August 2005

Supersedes Publication 1761-UM006D-EN-P - March 2004

Copyright © 2005 Rockwell Automation, Inc. All rights reserved. Printed in the U.S.A.