

Coupling Module for Remote Bus

Publication No.
D KWL 6315 92 E, Edition 01/94
Replacing D KWL 6315 92 E, Edition 09/92

88FT05/R1200

Application

This module is used in conjunction with the 88TK05 station bus coupling module to couple the PROCONTROL station to the remote bus.

It is coupled to the 88TK05 station bus coupling module via an RS485 interface.

Coupling to the remote bus can be done using one channel or two channels (see block diagram "Station connections").

The RS485 interface is suitable to connect a maximum of four PROCONTROL stations located in two mechanically coupled cabinets.

Features

This module can be used, together with the 88TK05 station bus coupling module, in any PROCONTROL cabinet.

The module is equipped with

- a standard interface for the PROCONTROL remote bus branch line
- an RS485 interface for the 88TK05 station bus coupling module
- a module data interface for the 88TK05 station bus coupling module

The module transfers station bus data to and from the remote bus.

The 88FT05 module does not use any module address in the PROCONTROL station.

Via the RS485 interface, it is supplied with its operating voltage US (+24 V). The external terminating resistors of the RS485 interface are fed by the 88FT05 module.

The telegrams received from the remote bus are monitored for distorted characters. This guarantees fault-free transfer.

The telegram transmitters are monitored for excessively long telegram sending, and the noise transmitters are monitored for excessively long noise signals.

The transmission levels of telegram transmitters and of noise transmitters are measured and are transferred through the RS485 interface to the 88TK05 station bus coupling module. The 88TK05 monitors these transmission levels.

The module generates the baseband (within 0.1 ... 2 MHz) required for telegram transmission on both remote bus channels, as well as the noise signal (within 5 ... 7 MHz) required for acknowledgement and event detection. It converts the bi-phase signals of the remote bus into the series-mode signals (TTL level) of the RS485 interface and vice versa.

The 24 V supply of the transmitter output stages can be disconnected by an ESP signal of the RS485 interface using a relay.

Module design

The module mainly consists of:

- Channel selection circuit
- Remote bus modem
- Level multiplexer
- Manchester encoder/decoder
- Noise signal logic
- RS485 interface
- Module data interface

Channel selector circuit

The channel selector circuit allows to connect two (redundant) remote bus channels to the bus coupling module.

Channel selection is permanent as soon as a complete receive SYN symbol is recognized. This symbol indicates the beginning of a data telegram arriving via the remote bus. This way, the selector circuit is switched to the respective channel.

An incomplete receive SYN symbol does not effect any channel change-over.

Remote bus modem

This modem is used to condition and adapt the data signals to the PROCONTROL remote bus.

The modem generates the noise signals required for acknowledgement and event detection.

At the remote bus modem inputs DA1N, DA2N (for remote bus channel A) or DB1N, DB2N (for remote bus channel B), the transmitted signal is taken over by the Manchester encoder and is transferred further – through an output stage with data filter – to remote bus modem outputs FAA, FAB for remote bus channel A, or to outputs FBA, FBB for remote bus line B.

Through a data filter, the received signal is forwarded to a following equalizing amplifier.

From remote bus modem outputs IEA (for remote bus channel A) or IEB (for remote bus channel B), the received data are transmitted to the Manchester decoder carrying out the signal conversion required for the RS485 interface.

The noise signal for telegram acknowledgement and event indication is transmitted by the noise signal logic using remote bus modem inputs RA1N, RA2N (for remote bus channel A) or RB1N, RB2N (for remote bus channel B).

These signals are amplified, filtered through a bandpass filter, and superimposed – using an output stage at the remote bus modem outputs FAA, FAB (for remote bus channel A) or FBA, FBB (for remote bus channel B) – to the signals of the telegram transmitter output stages.

Using outputs SPA and RPA (for remote bus channel A) or SPB and RPB (for remote bus channel B), the remote bus modem transmits the transmission levels of the telegram transmitters and noise transmitters back to the level multiplexer of the module.

Signal ESP of the RS485 interface activates the 24 V supply of the transmission output stages, jointly for both remote bus channels, using a high signal level. For this purpose, using remote bus modem input NA, it energizes a relay which will switch on the output stages.

Level multiplexer

The level multiplexer applies the transmission level and the noise level of the active remote bus channel to signal SP and RP of the RS485 interface. Evaluating the transmission level and signalling the fault to the PROCONTROL system takes place on the 88TK05 station bus coupling module.

Manchester encoder/decoder

For each remote bus channel a separate Manchester encoder/decoder is provided.

The Manchester encoder converts signals RA, DA and TA, which are received from the RS485 interface, into the remote bus modem signals DA1N, DA2N, DB1N and DB2N. Additionally, these signals are given SYN symbols.

Signals DA1N, DA2N or DB1N and DB2N will become active only after they have been released by the 88TK05 station–bus coupling module together with signals SE1 or SE2 respectively from the RS485 interface and if the transmitter monitoring function did not respond.

The Manchester decoder converts signal IEA or IEB received from the remote bus modems into signals RA, DA, TA for the RS485 interface. In addition, the SYN symbols of these signals are removed.

Signals RA, DA, TA will become active only after they have been released by the channel selector circuit.

Furthermore, a character distortion in the received data signals causes the reception monitoring function to render signals RA, DA, TA inactive. This is recognized by the 88TK05 module and the data are not being evaluated. Instead, the 88TK05 prompts repeated output of the telegram. Thus, no data are lost.

Noise signal logic

The noise signal logic generates the noise signal (5 ... 7 MHz) as required for event signalling and telegram acknowledgement.

remote bus modem signals RA1N, RA2N or RB1N, RB2N are generated from a noise signal of limited frequency and amplitude, signal RE (noise transmitter ON) of the RS485 interface, and a control signal issued by the channel selector circuit.

RS485 interface

In this circuit section, conditioning and adaptation of the signals to the 88TK05 station–bus coupling module take place.

All signals of this interface will be transmitted with their true and inverse values.

This interface according to RS485 includes the following signals:

SE1+, SE1–,	Telegram transmitter remote bus channel A ON
SE2+, SE2–,	Telegram transmitter remote bus channel B ON
RE+, RE–,	Noise transmitter ON
DA+, DA–,	Telegram data
RA+, RA–,	Telegram frame
TA+, TA–,	Telegram clock pulse
SP+, SP–,	Checkback signal for transmission level of the active remote bus channel
RP+, RP–,	Checkback signal for noise level of the active remote bus channel
FS+, FS–,	Signal "Remote bus coupling disturbed"
ESP+, ESP–,	Inhibit output stages
ANB+, ANB–,	Signal "Active remote bus channel" (channel A = 1, channel B = 0)
SGD, SGD,	Reference conductor RS485 interface
US, US,	+24 V for 88FT05
Z, Z,	Reference conductor for +24 V.

Module data interface

This interface is used for transmitting internal module data to the 88TK05 station bus coupling module.

When several 88TK05 station–bus coupling modules are connected to one 88FT05 remote-bus coupling module, this interface may be connected to the first 88TK05 station–bus coupling module only.

Diagnosis and annunciation functions

The module is not equipped with any light–emitting diodes for disturbance annunciations. Disturbances are indicated on the 88TK05 station–bus coupling module.

The signal coming from the general disturbance line and the signals transmitted to the CDS are shown in Figure 1.

Reception monitoring on the 88FT05 and the 88TK05

The reception monitoring function on the 88FT05 monitors the telegrams received for distorted characters.

When the reception monitoring function responds, transmission of frame, data, and clock pulse (RA, DA, TA) is canceled on the RS485 interface between 88FT05 and 88TK05 until the next valid SYN symbol is received.

Then the cancel detector of the reception monitoring function on the 88TK05 will respond. The 88TK05 module indicates the presence of this disturbance by entering "Acknowledged error on remote bus" (bit 8) into its diagnosis register.

Transmitter monitoring on the 88FT05 and the 88TK05

The 88TK05 station bus coupling module which controls the telegram transmitters and the noise transmitters on the 88FT05 module, monitors the telegram transmitters of the active remote bus channel for absence of the transmission signal level and excessively long telegram transmission, i.e. telegram frames exceeding 63 μ s. It also monitors the noise transmitters of the active remote bus channel for absence of the noise signal level.

The transmitter monitoring function of the 88FT05 module monitors the telegram transmitter of the active remote bus channel for excessively long telegram transmission, i.e. transmission of more than 64 telegrams without interruption by reception of a complete telegram. It also monitors the noise transmitter of the active remote bus channel for an excessively long noise signal, i.e. any occasion where the noise transmitter remains ON for more than 10 ms without any interruption.

An excessively long transmission telegram, overly long telegram transmission, or an excessively long noise signal causes the 88FT05 module to permanently disconnect the drivers of the disturbed telegram transmitter until the end of the cycle, using the signals SE1 or SE2.

Reconnection of the drivers through the 88TK05 using signals SE1 or SE2 will be effected after the telegram "Start cycle" has been received.

After the transmitter monitoring function for the telegram or noise transmitters has responded three consecutive times, the drivers of the disturbed telegram or noise transmitter will remain disconnected.

Each of the disturbances described above is indicated by the entry "Transmit path fault" (bit 9) in the diagnostic register (GA60/61) of the 88TK05 module.

Disturbance signals to the annunciation system

The annunciation system and the CDS control diagnostic system receive the disturbance signals from the station bus coupling module via the PROCONTROL bus.

It includes all disturbances which are recognized by the transmitter monitoring functions on the 88FT05 module.

Status annunciations

Green light–emitting diodes on the front panel indicate the following operating statuses of the active remote bus channel:

TS	Telegram transmission
QES	Acknowledgement and event transmitter active
A	Remote bus channel A active
B	Remote bus channel B active.

Annunciation lamp TS signals transmission of telegrams to the remote bus.

Annunciation lamp QES indicates acknowledgement of received remote bus telegrams and signalling of events from station–bus modules to the master station.

Annunciation lamps A and B indicate activity on the respective remote bus channel.

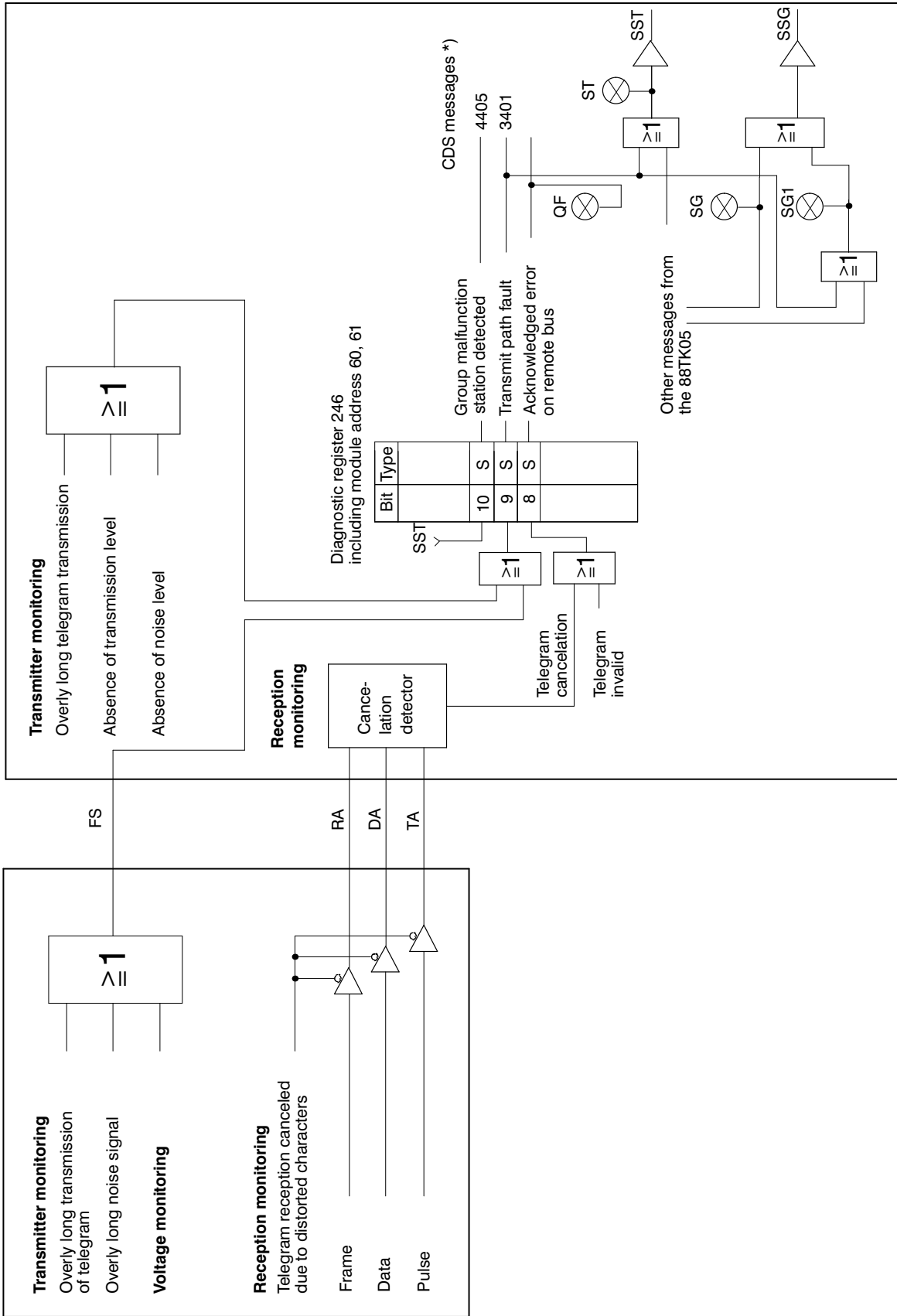

Figure 1: 88FT05 diagnostic messages

Length of the remote bus lines

The maximum permissible length of the remote bus line is dependent on the number of the remote bus junction modules 88FK05 used and on the dimensioning of the noise receiver in the master station modem module 88FV01/R0100/R0200.

The bus range chart shows the permissible remote bus length in relation to the number of remote bus junction modules 88FK05 for the versions R0100 and R0200 of the master station modem module 88FV01.

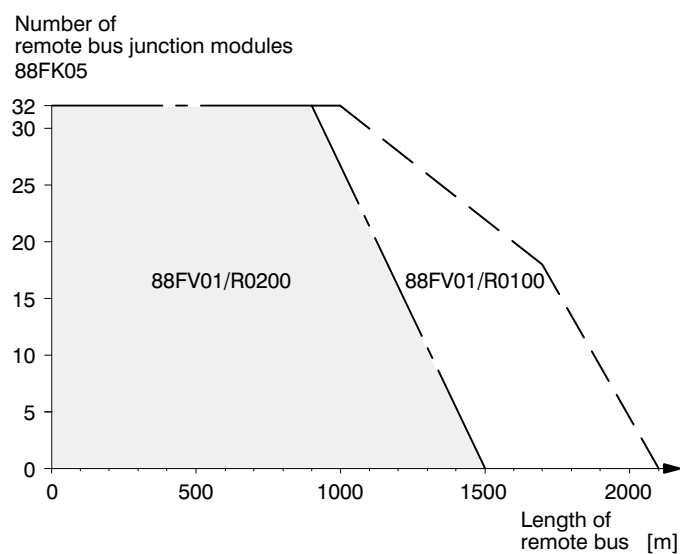

Figure 2: Bus range chart

Function diagram

X11 includes a standard interface for the remote bus branch line.

Terminal designations

The printed-circuit board is provided with connectors X11 and X21.

X21 includes an RS485 interface, a module data interface for station-bus coupling module 88TK05, as well as an UD voltage supply for the external terminating resistors of the RS485 interface.

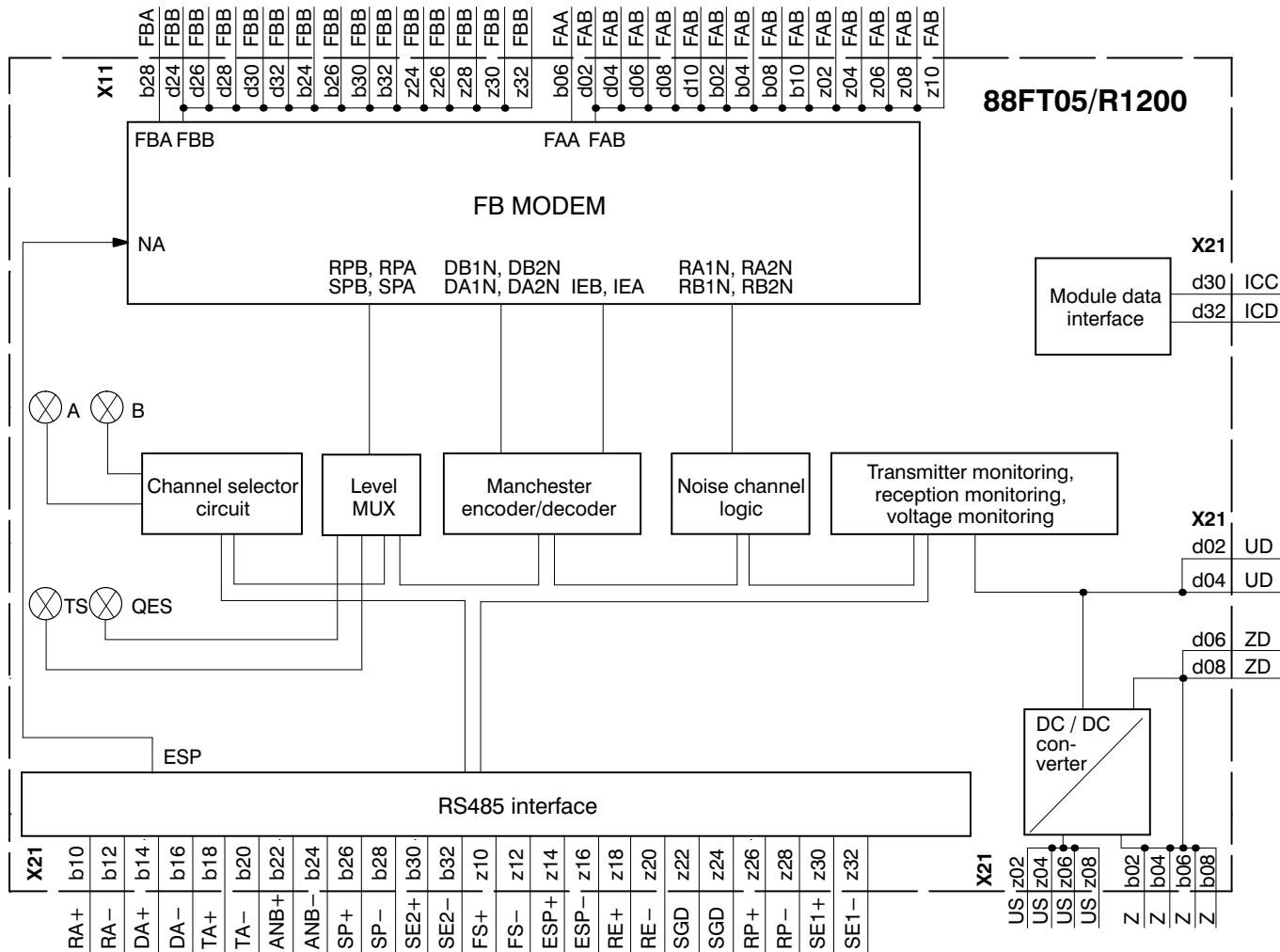

Block diagram of station connections

Single-channel station bus coupling

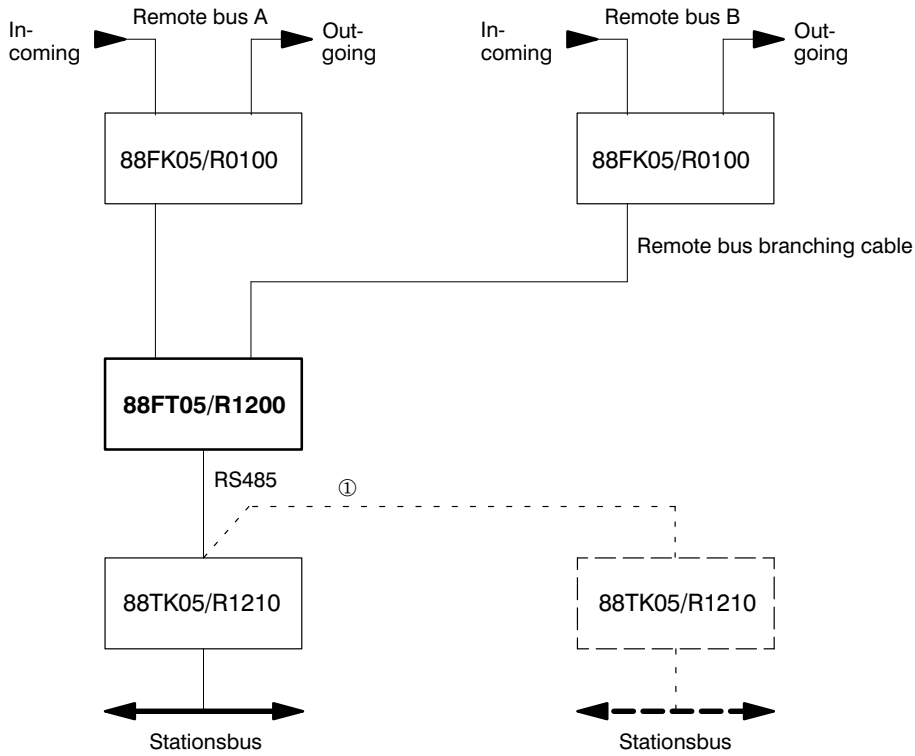

Dual-channel station bus coupling

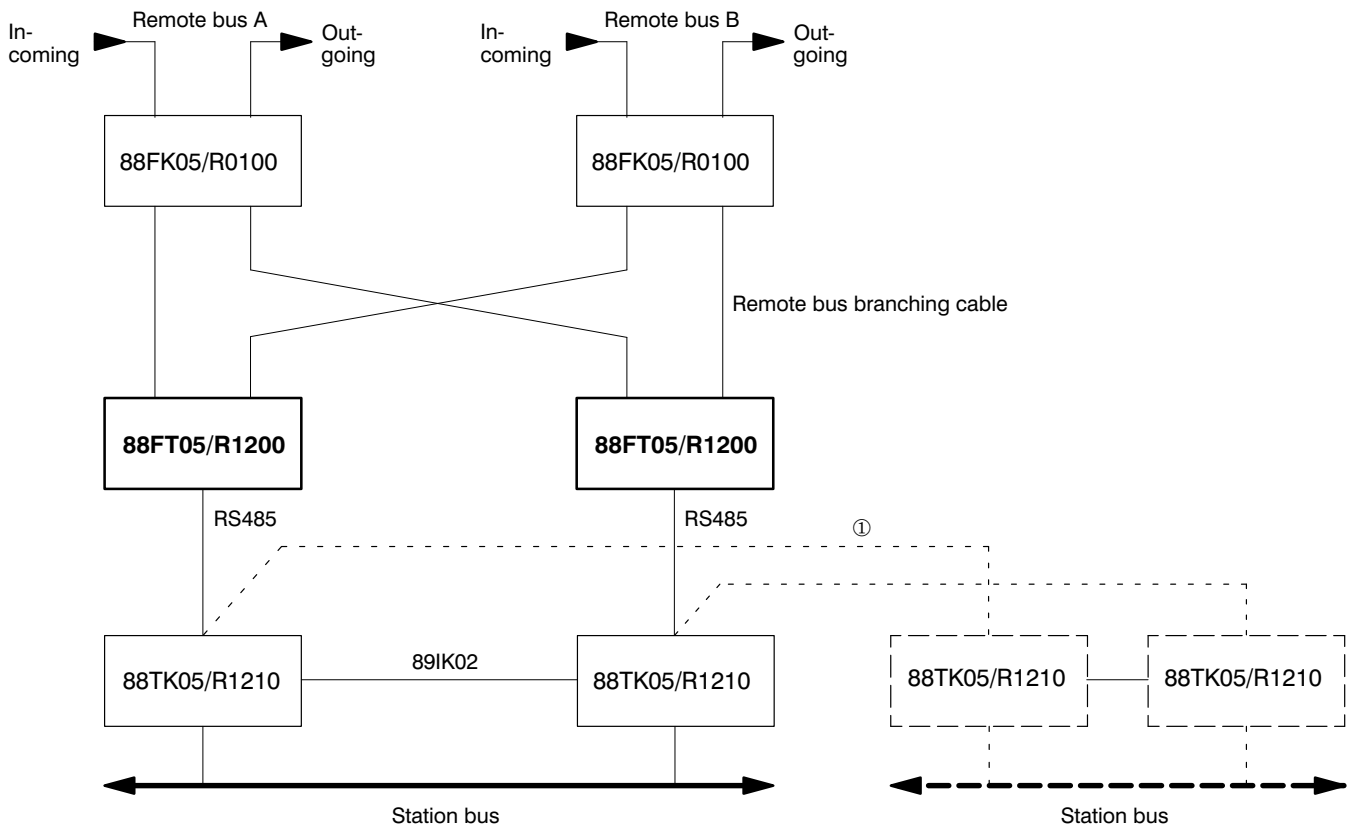

① A maximum of four stations can be connected in two neighbouring cabinets.

Mechanical design

Board size: 6 units, 2 divisions, 160 mm deep

Connectors: X11, X21 acc. to DIN 41 612
 2 x 48-pole edge-connector, type F
 X1 acc. to MIL-C-24 308
 1 x 37-pole female connector, type HDP 20

Weight: approx. 0.5 kg

View of connector side:

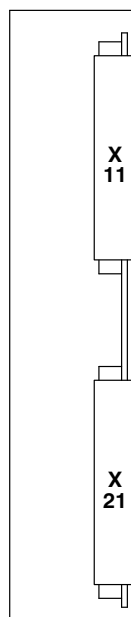

Contact assignments of connector X21

View of contact side:

	<i>d</i>	<i>b</i>	<i>z</i>
02	UD	Z	US
04	UD	Z	US
06	ZD	Z	US
08	ZD	Z	US
10		RA+	FS+
12		RA-	FS-
14		DA+	ESP+
16		DA-	ESP-
18		TA+	RE+
20		TA-	RE-
22		ANB+	SGD
24		ANB-	SGD
26		SP+	RP+
28		SP-	RP-
30	ICC	SE2+	SE1+
32	ICD	SE2-	SE1-

Contact assignment of connector X11

View of contact side:

	<i>d</i>	<i>b</i>	<i>z</i>
02	FAB	FAB	FAB
04	FAB	FAB	FAB
06	FAB	FAA	FAB
08	FAB	FAB	FAB
10	FAB	FAB	FAB
12			
14			
16			
18			
20			
22			
24	FBB	FBB	FBB
26	FBB	FBB	FBB
28	FBB	FBA	FBB
30	FBB	FBB	FBB
32	FBB	FBB	FBB

View of module side and module front

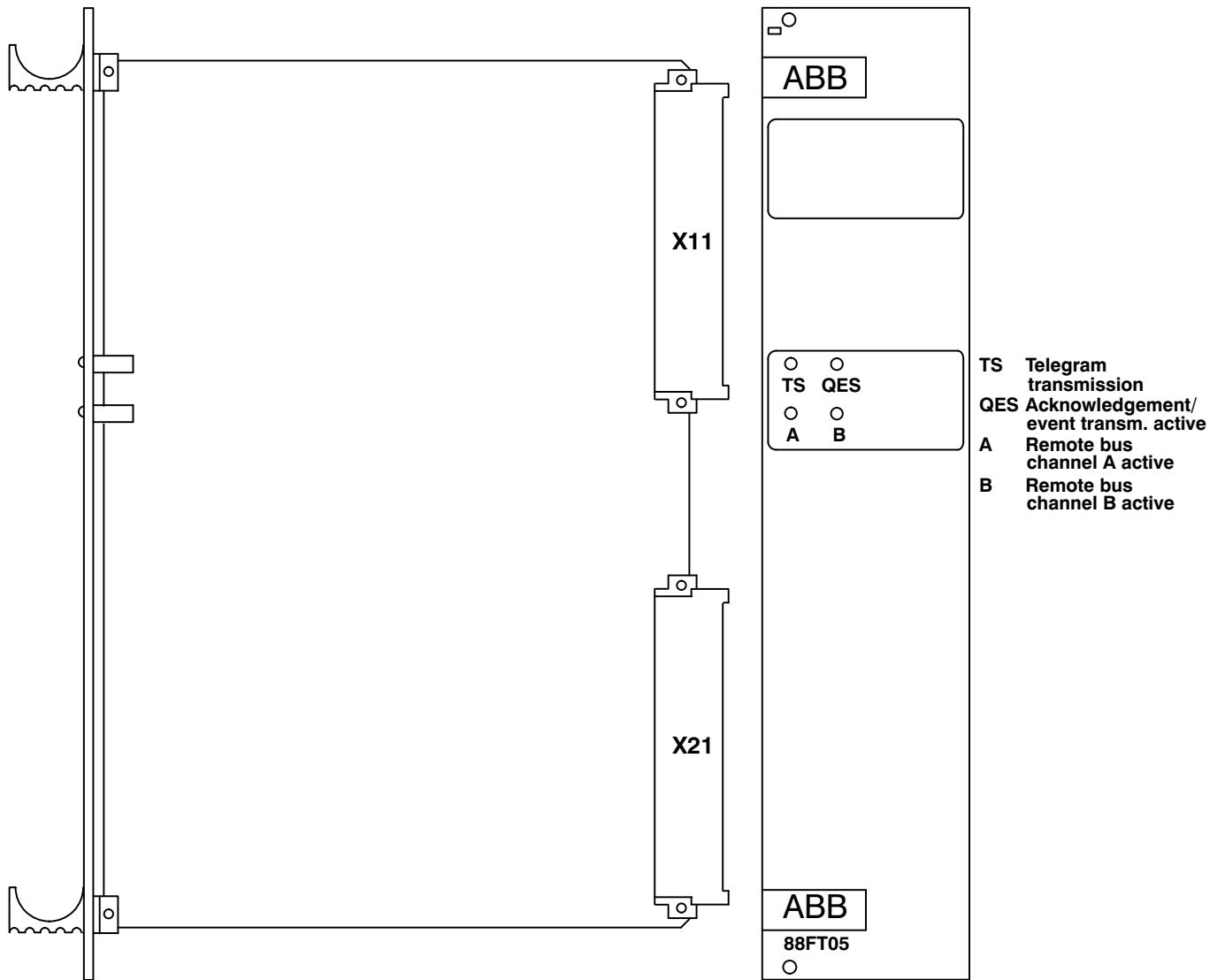

Technical data

In addition to the system data, the following values apply:

Power supply (on the module)

Operating voltage	24 V +/- 25 %
Current consumption	max. 1.1 A
Power dissipation	typ. 20 W
Power dissipation	max. 33 W

Standard interface for remote bus branch–line module 88FK05 (FBA, FBB, FAA, FAB)

Transfer rate	1 MBaud
Terminating resistance	50 Ohm
Data transmission voltage	15 ... 30 V _{ss}
Input sensitivity	≤ 12 mV _{ss}
Noise signal voltage	3.5 ... 6 V _{eff}
Max. length: for use outside of cabinet	50 m, cable type RG 58 with additional shield
for use inside of cabinet	10 m, cable type RG 58

RS485 interface for station bus coupling module 88TK05 (RS485 standard)

Transfer rate	1 MBaud
Terminating resistance	100 Ohm
Passive differential signal voltage	400 mV
Max. length of connection between 88TK05/88TK05	10 m (total), cable type RD–Y(ST)Y 16 x 2 x 0.22 mm or standard wiring
Max. length of connection between 88TK05/88FT05	1 m, cable 89IK01
Max. number of stations in two mechanically coupled cabinets	4

Noise immunity

when installed according to instructions

ESD acc. to IEC 801/2	8 kV to front panel
EMC acc. to IEC 801/4	2 kV burst coupled into remote bus cable

ORDERING DATA

Order no. for overall module:

Type designation: 88FT05/R1200

Order no.: GJR2393100R1200

Accessories:

Cable 89IK02 for dual–channel station bus coupling

Order no.: GKWE 602380R0090

Technical data are subject to change without notice!



ABB Kraftwerksleittechnik GmbH

P. O. Box 100351, D-68128 Mannheim
Phone (0621) 381 2712, Telefax (0621) 381 4372
Telex 462 411 107 ab d

Printed in Germany (KWL/E69 894 0,3 BID)