

# CHAPTER 2 - SYSTEM DESCRIPTION

## 4. SINGLE CHANNEL CONTROL CARDS

### 4.1 General

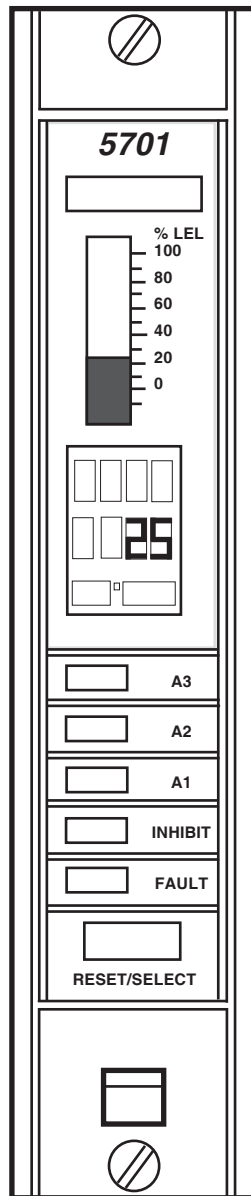

The 5701 Single Channel Control Card provides control, display and alarm facilities for a connected gas detector. The front panel display indicates the gas reading and channel status while LEDs are used for alarms. A push-button is provided for resetting the alarms and selecting the card for use with the Engineering Card.

The operation of the control card is microprocessor controlled and is fully definable for a wide range of connected gas detectors and application requirements. The software configuration setup is stored in an EEPROM.

There are two types of control card depending on the type of gas detector being fitted to the system:

- a. Single Channel Control Card 4 - 20mA.  
Part Number 05701-A-0301.
- b. Single Channel Control Card Catalytic.  
Part Number 05701-A-0302.

Each of the above control cards consist of a single channel control card fitted with the respective plug-in sensor drive module.

An optional Analogue Output Module can also be plugged into the single channel control card to provide a remote output of the channel card readings.

---

# CHAPTER 2 - SYSTEM DESCRIPTION

---

## 4.2 Single Channel Control Card

The Single Channel Control Card carries out the control functions for a single loop of gas detection as follows:

- a. Processes the incoming sensor drive module signal.
- b. Displays the signal level on the front panel liquid crystal display.
- c. Compares the signal level with pre-defined alarm limits.
- d. When the pre-defined alarm limits are exceeded, raises the alarms by lighting up front panel LEDs and operating optional connected relays.
- e. Informs other cards with the alarm status information.
- f. Self validates the operation of its circuit components, software operation and the condition of the sensor.

## 4.3 Sensor Drive Modules

Two sensor drive modules are provided:

- a. Sensor Drive Module, 4 - 20mA, Part Number 05701-A-0283
- b. Sensor Drive Module Catalytic, Part Number 05701-A-0284

The Sensor Drive Module conditions the incoming catalytic or 4 - 20mA sensor signal and provides the necessary sensor power supply. It contains all the circuitry necessary to generate the voltages and currents required to drive the sensor, the circuitry to acquire the sensor signal and to scale the sensor signal to a standard output. The sensor drive modules are factory fitted and plug directly onto the channel control card.

## 4.4 Analogue Output Module

An optional Analogue Output Module, (Part Number 05701-A-0285), may be factory fitted to the Single Channel Control Card and is used on a channel of gas detection to provide an isolated current loop output which follows the sensor signal level. This may be set electronically to produce a 0 - 20mA output or a 4 - 20mA output and can be used to operate a chart recorder, etc.

# CHAPTER 2 - SYSTEM DESCRIPTION

## 4.5 Single Channel Control Card Physical Layout

The physical layout of the Single Channel Control Card is shown below. The Sensor Drive Modules plug into the 14-way connectors J1 and J2 while the Analogue Output Module, when fitted, plugs into J3 and J4. Link LK1, available on MkII cards only, is used when individually powering control cards See Chapter 4, Section 16.2.

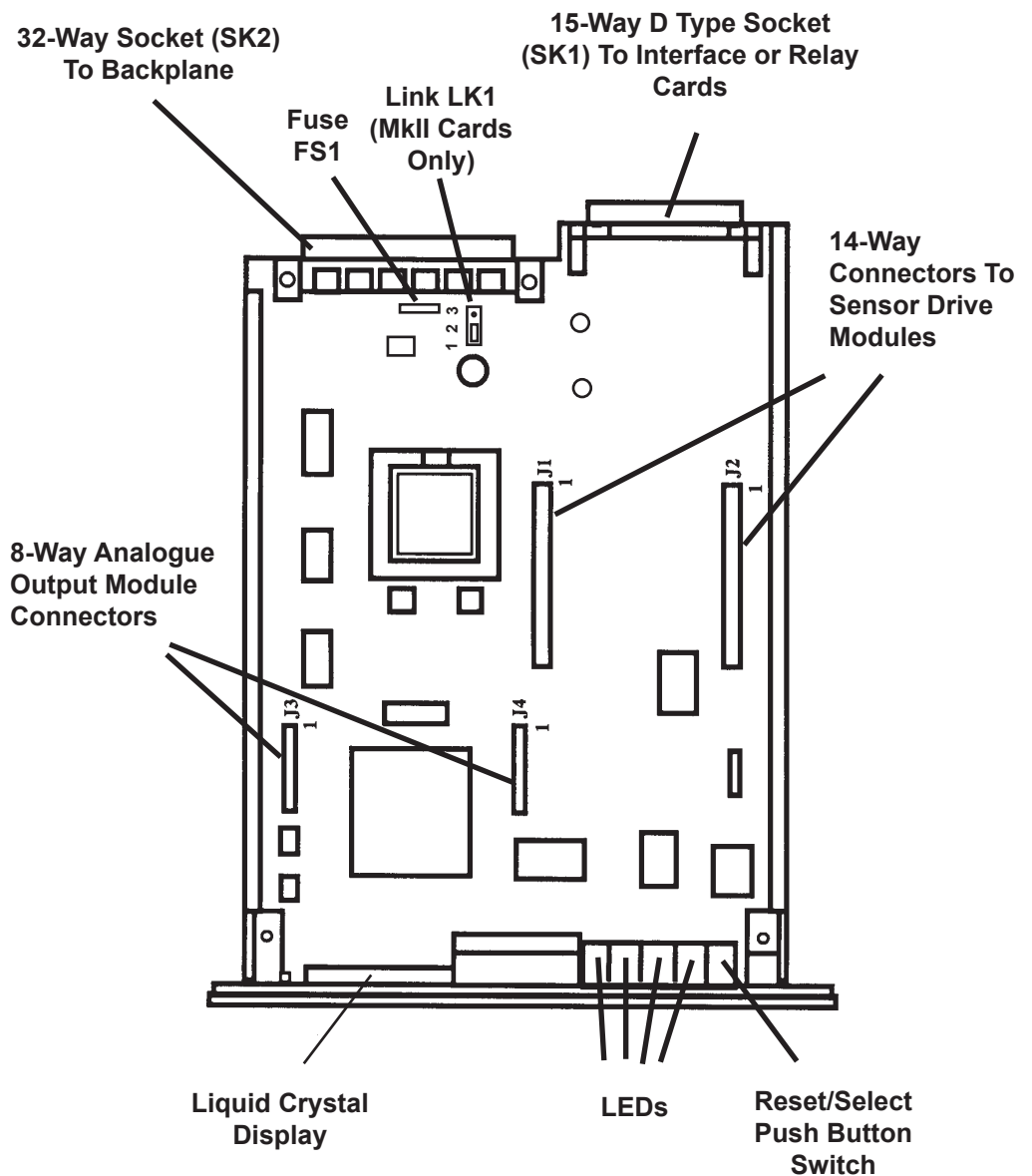

---

# CHAPTER 2 - SYSTEM DESCRIPTION

---

## **5. FIELD INTERFACE AND RELAY CARDS**

### **5.1 General**

The Field Interface Card and the four types of relay card provide the interface between a Single Channel Control Card and the field wiring.

### **5.2 Field Interface Card (Part Number 05701-A-0326)**

#### **5.2.1 General**

For use in systems with master relays. Used on all channels except the master. Provides connections between the sensor and the control card only. No relays fitted.

# CHAPTER 2 - SYSTEM DESCRIPTION

## 5.2.2 Rear Access Connections

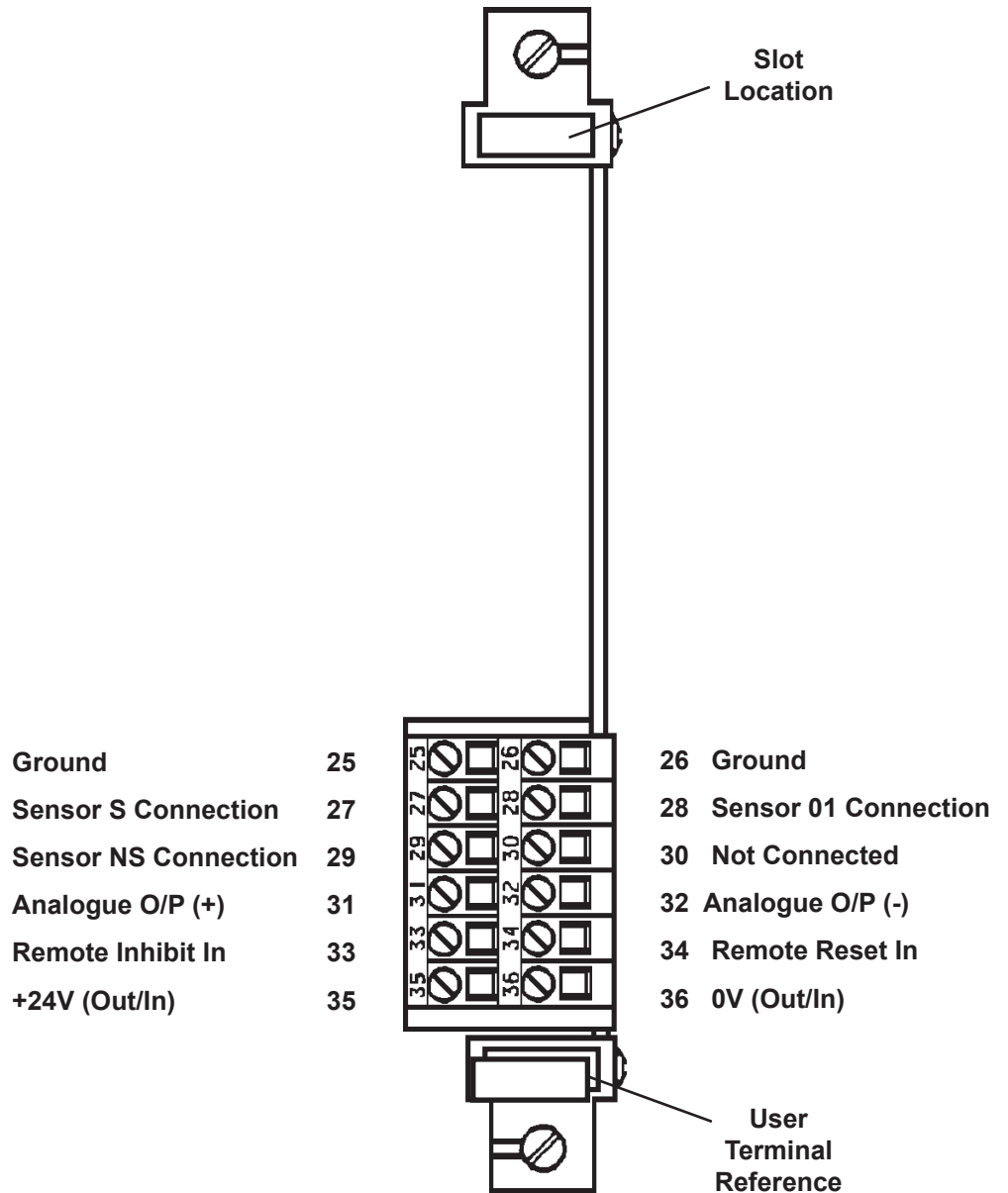

# CHAPTER 2 - SYSTEM DESCRIPTION

## 5.2.3 Front Access Connections

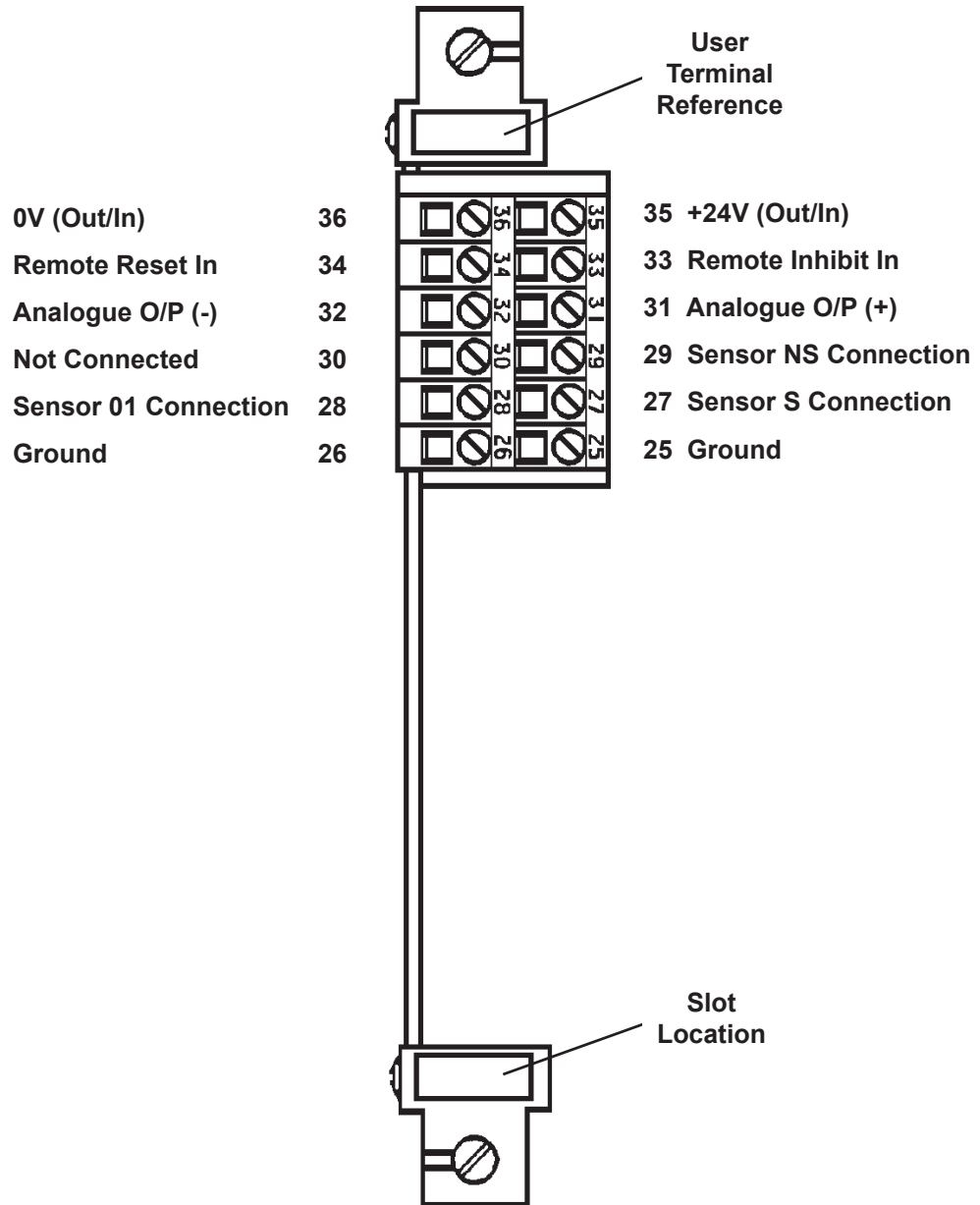

# CHAPTER 2 - SYSTEM DESCRIPTION

## 5.3 Double SPCO Relay Card (Part Number 05701-A-0327)

### 5.3.1 General

Provides connections between the sensor and the control card in the same way as the Field Interface Card. In addition, single pole relays provide voltage free contact outputs for the A1 alarm level, A2 alarm level and fault condition.

### 5.3.2 Rear Access Connections

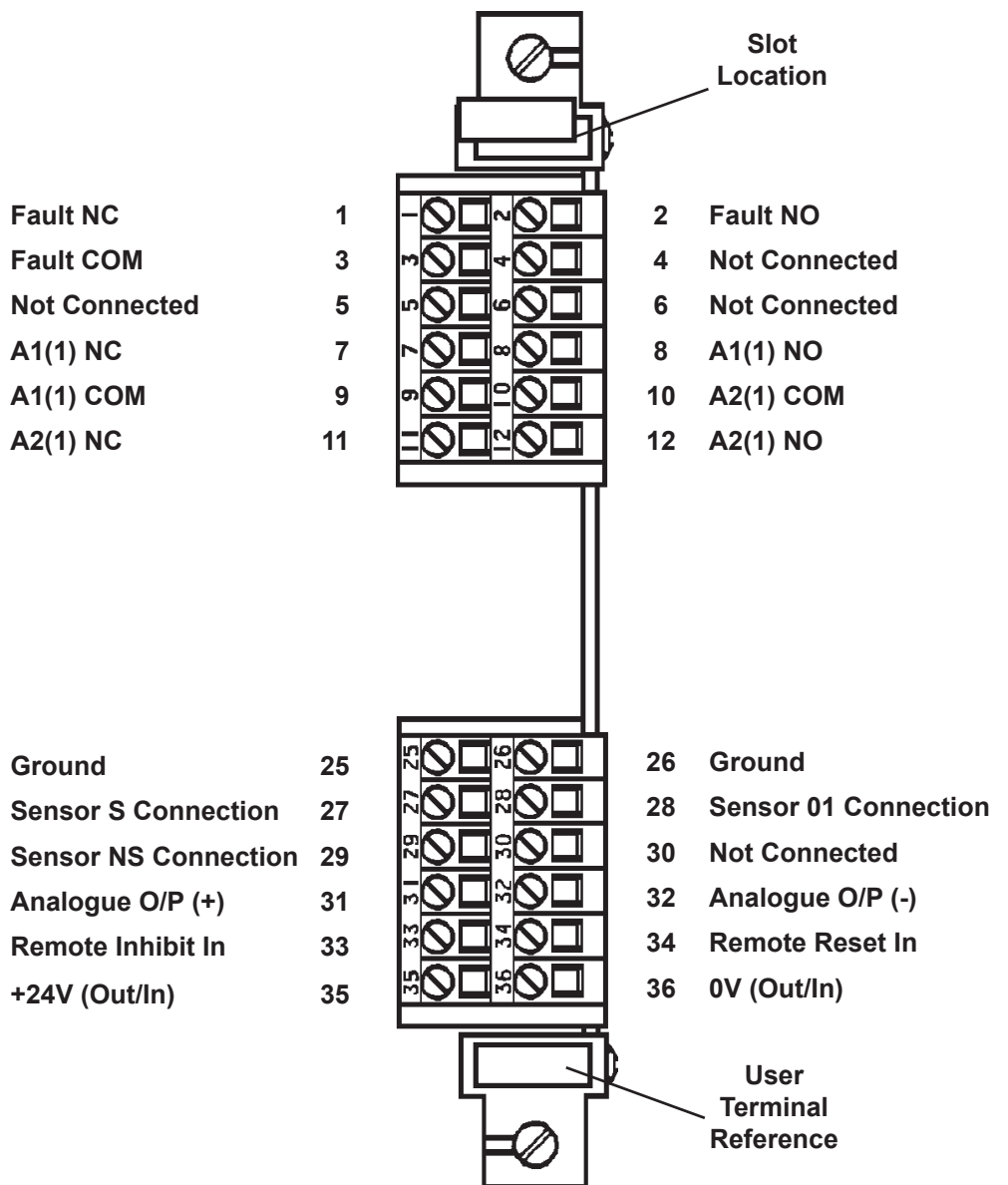

NC = Normally Closed. NO = Normally Open. COM = Common.

Relay contact conditions refer to the no power state of the relay.

# CHAPTER 2 - SYSTEM DESCRIPTION

## 5.3.3 Front Access Connections

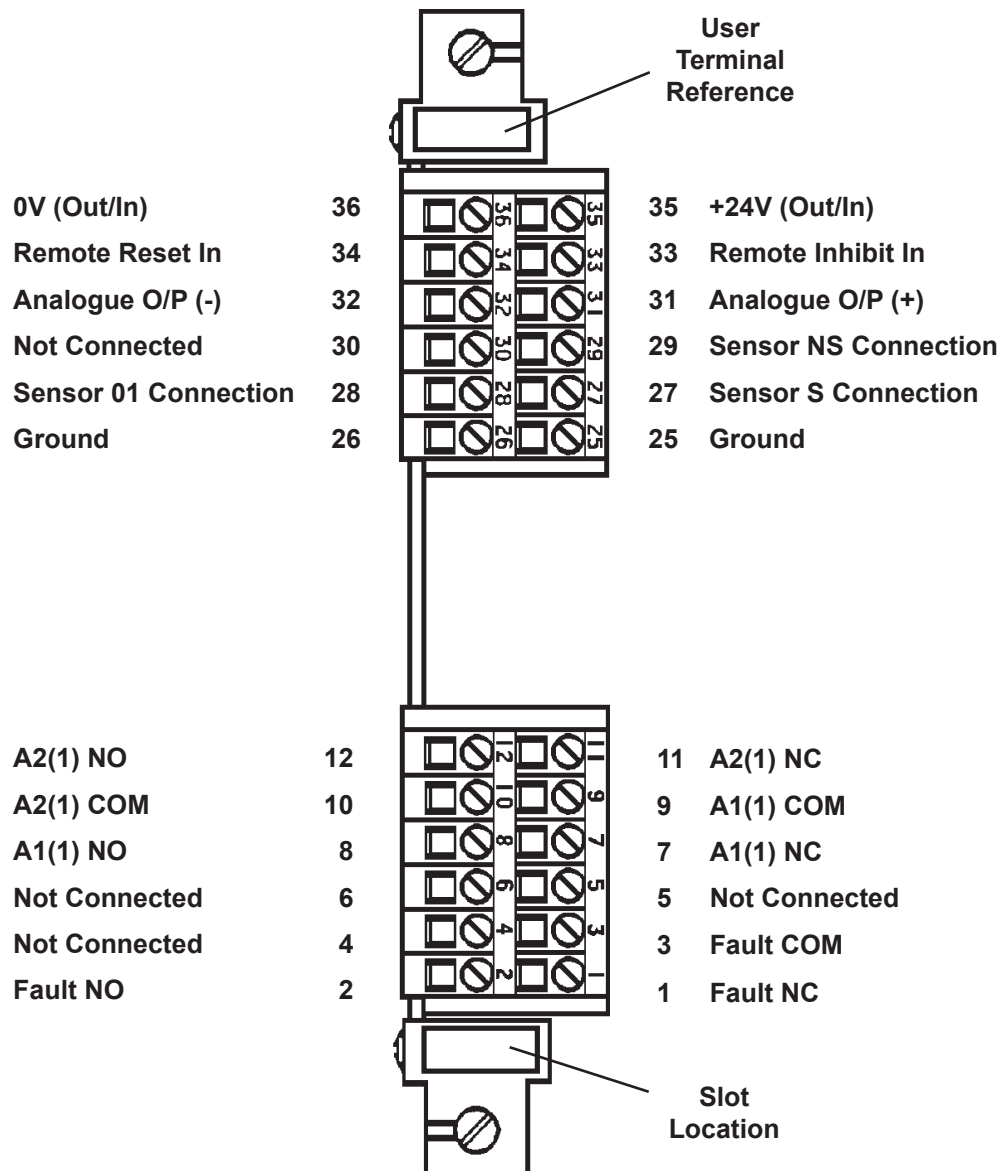

NC = Normally Closed. NO = Normally Open. COM = Common.

Relay contact conditions refer to the no power state of the relay.



# CHAPTER 2 - SYSTEM DESCRIPTION

## 5.4 Triple SPCO Relay Card (Part Number 05701-A-0328)

### 5.4.1 General

Provides connections between the sensor and the control card in the same way as the Field Interface Card. In addition, single pole relays provide voltage free contact outputs for the A1 alarm level, A2 alarm level, A3 alarm level, fault and inhibit conditions.

### 5.4.2 Rear Access Connections

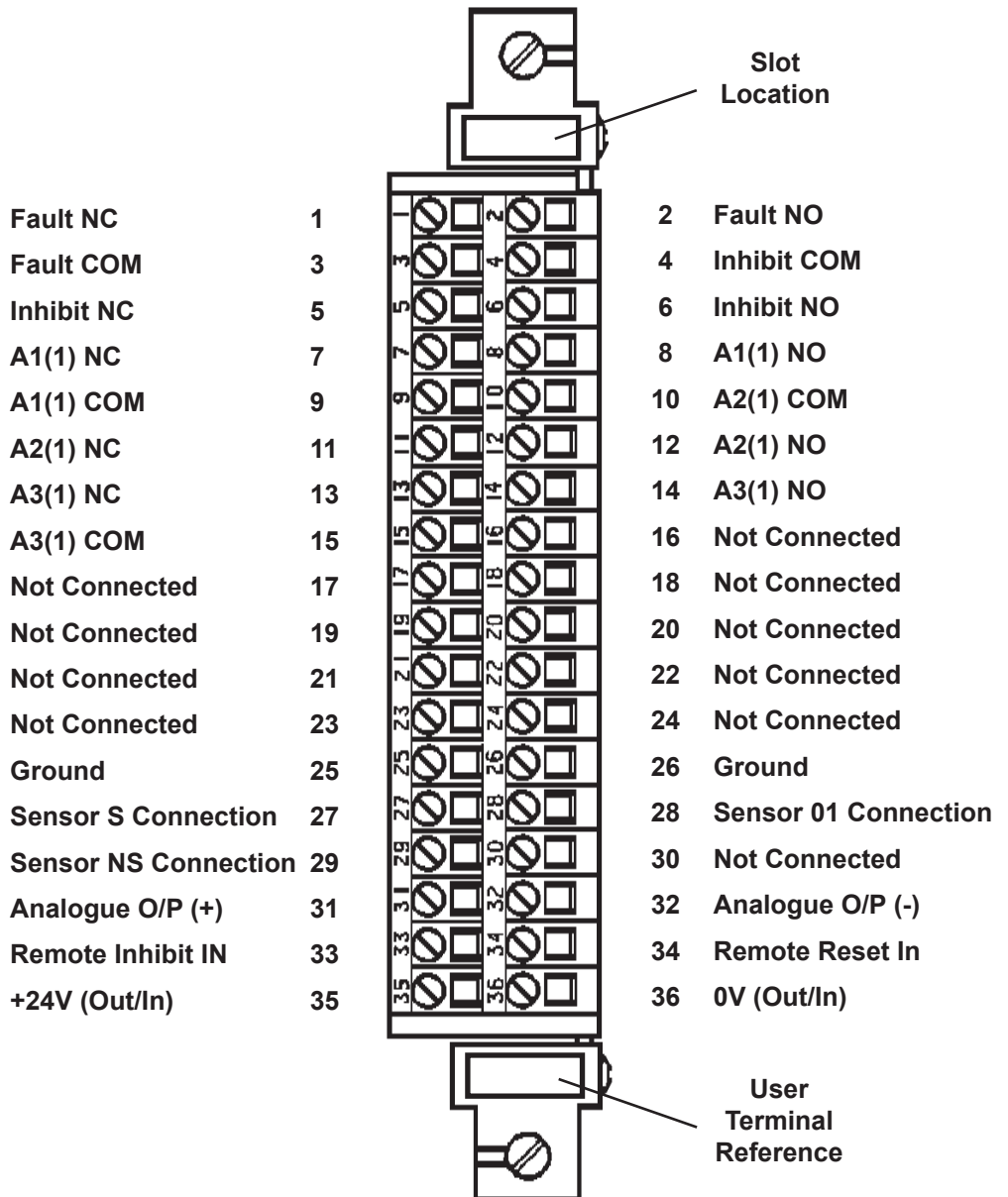

NC = Normally Closed. NO = Normally Open. COM = Common.

Relay contact conditions refer to the no power state of the relay.

# CHAPTER 2 - SYSTEM DESCRIPTION

## 5.4.3 Front Access Connections

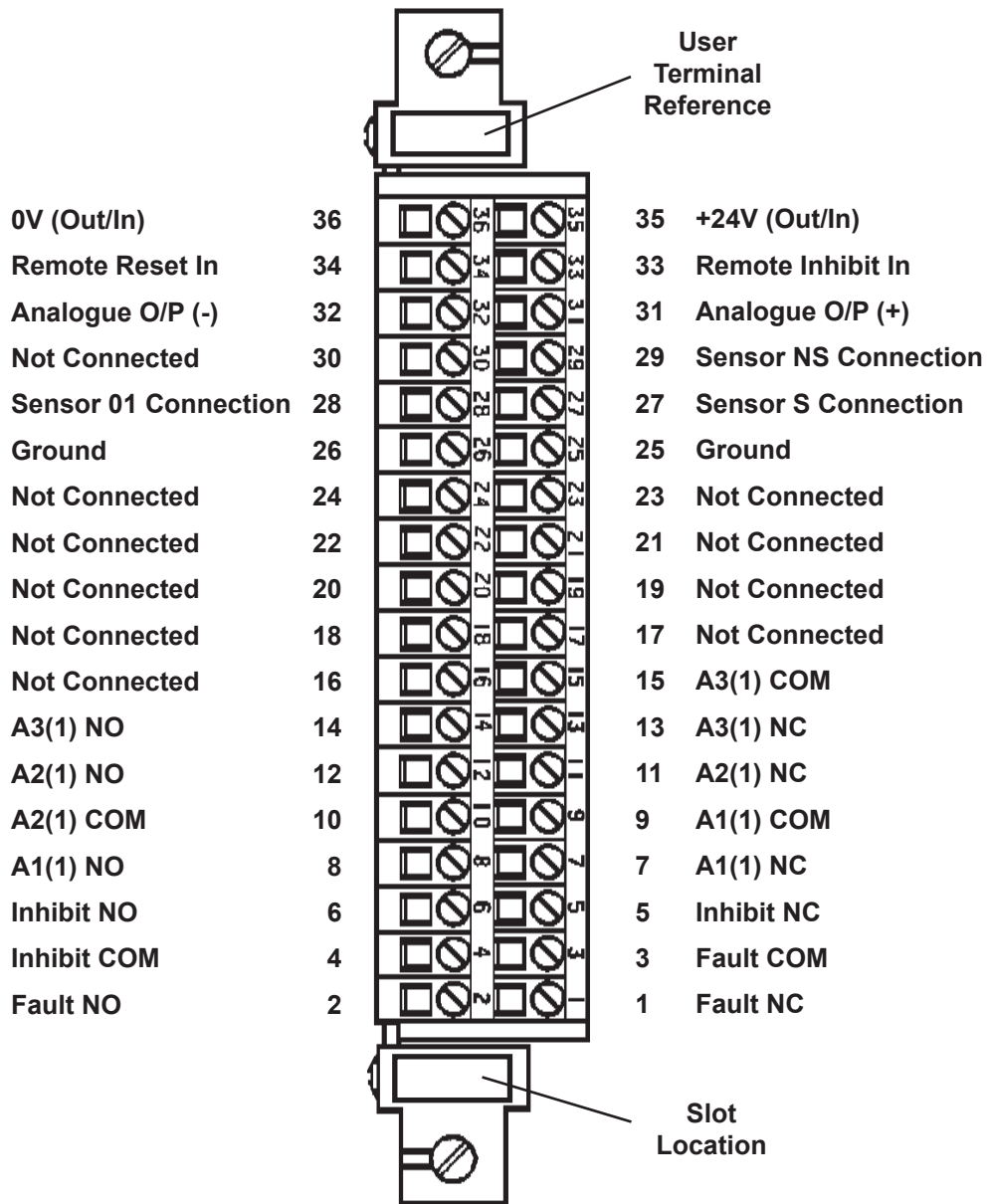

NC = Normally Closed. NO = Normally Open. COM = Common.

Relay contact conditions refer to the no power state of the relay.

# CHAPTER 2 - SYSTEM DESCRIPTION

## 5.5 Triple DPCO Relay Card (Part Number 05701-A-0329)

### 5.5.1 General

Provides connections between the sensor and the control card in the same way as the Field Interface Card. In addition, single pole relays provide voltage free contact outputs for 2 x A1 alarm level, 2 x A2 alarm level, 2 x A3 alarm level, fault and inhibit conditions.

### 5.5.2 Rear Access Connections

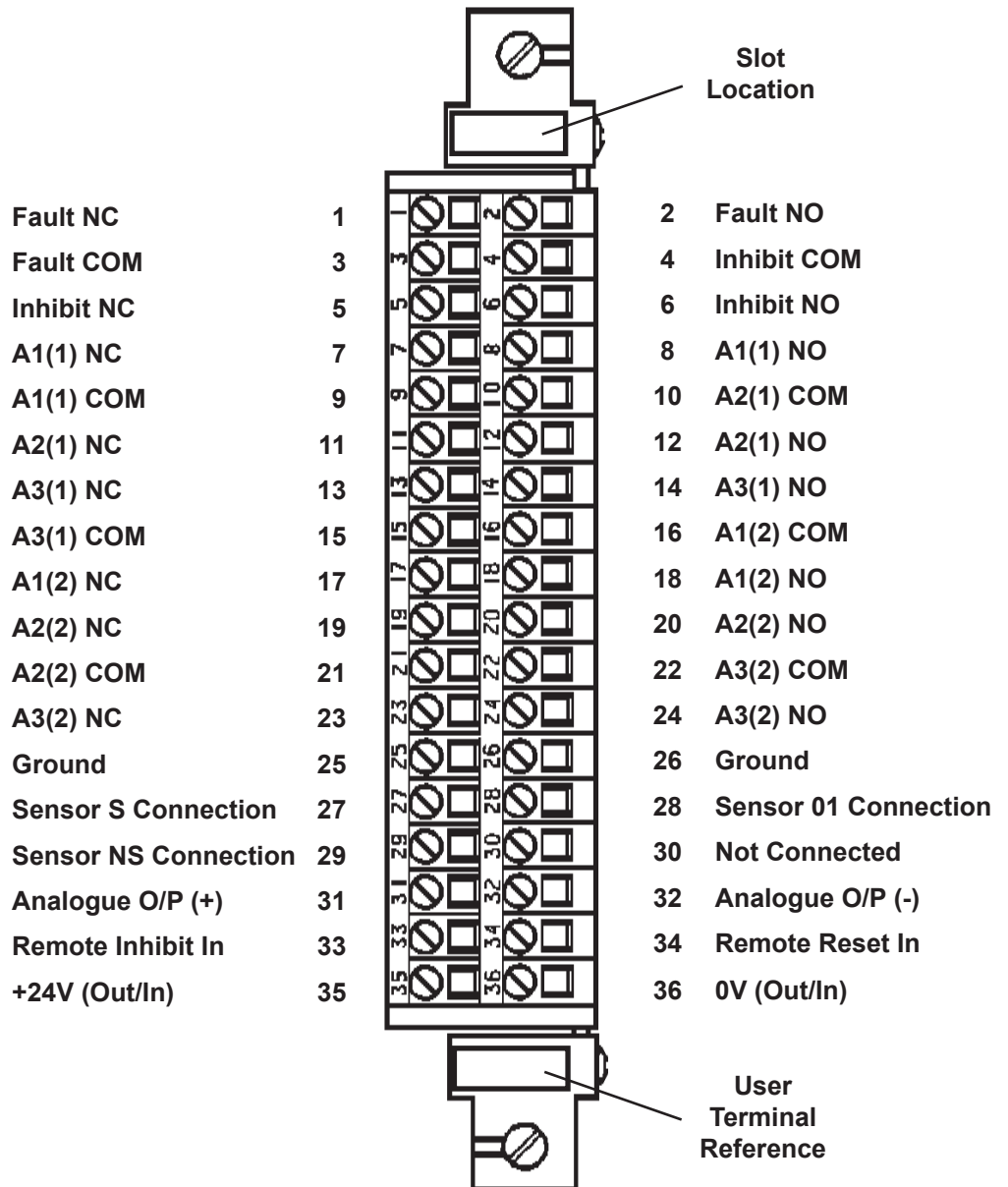

NC = Normally Closed. NO = Normally Open. COM = Common.

Relay contact conditions refer to the no power state of the relay.

# CHAPTER 2 - SYSTEM DESCRIPTION

## 5.5.3 Front Access Connections

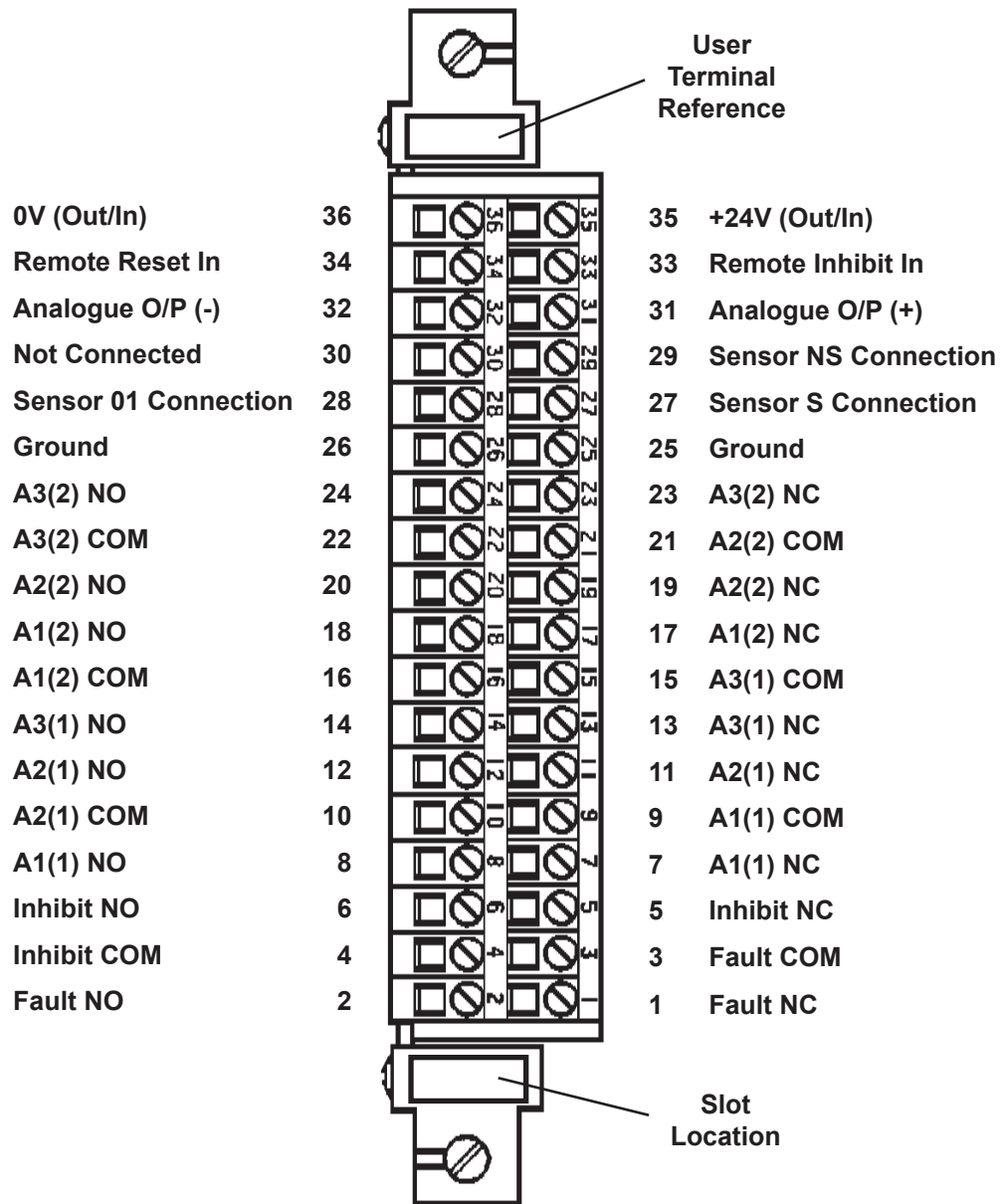

NC = Normally Closed. NO = Normally Open. COM = Common.

Relay contact conditions refer to the no power state of the relay.

---

## CHAPTER 2 - SYSTEM DESCRIPTION

---

### 5.6 High Integrity Relay Card (Part Number 05701-A-0330)

#### 5.6.1 General

Provides connections between the sensor and the control card in the same way as the Field Interface Card. This card is used to provide master alarm functions or a mixture of master and individual alarms. The card is fitted with eight relays, seven of which are fully configurable while the eighth is used for fault alarm. The relay states are monitored by the control card to ensure correct operation of the relays. In the case of a malfunction, the fault relay of the high integrity relay card de-energises. The fault relay shall always be monitored in order to ensure correct operation of the system.

Additional capabilities are available with this card including delayed switch on or switch off of the alarm relays.

Note: The High Integrity Relay Card can only be used with MKII Control Cards.

# CHAPTER 2 - SYSTEM DESCRIPTION

## 5.6.2 Rear Access Connections

### IMPORTANT

Refer to configuration printout, or use the Relays Screen of the Engineering Interface Software, to determine the relay function.

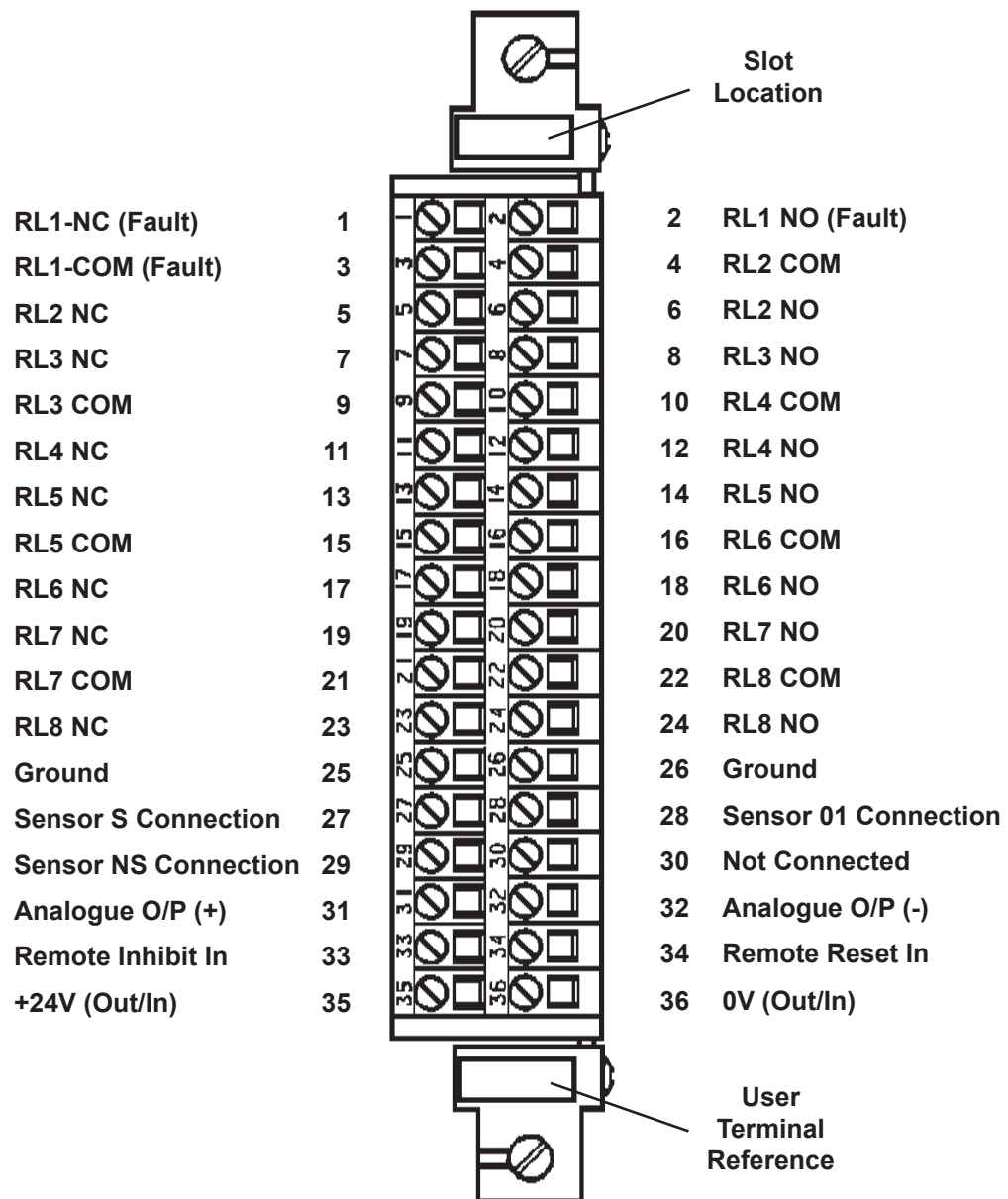

NC = Normally Closed. NO = Normally Open. COM = Common.

Relay contact conditions refer to the no power state of the relay.

# CHAPTER 2 - SYSTEM DESCRIPTION

## 5.6.3 Front Access Connections

### IMPORTANT

Refer to configuration printout, or use the Relays Screen of the Engineering Interface Software, to determine the relay function.

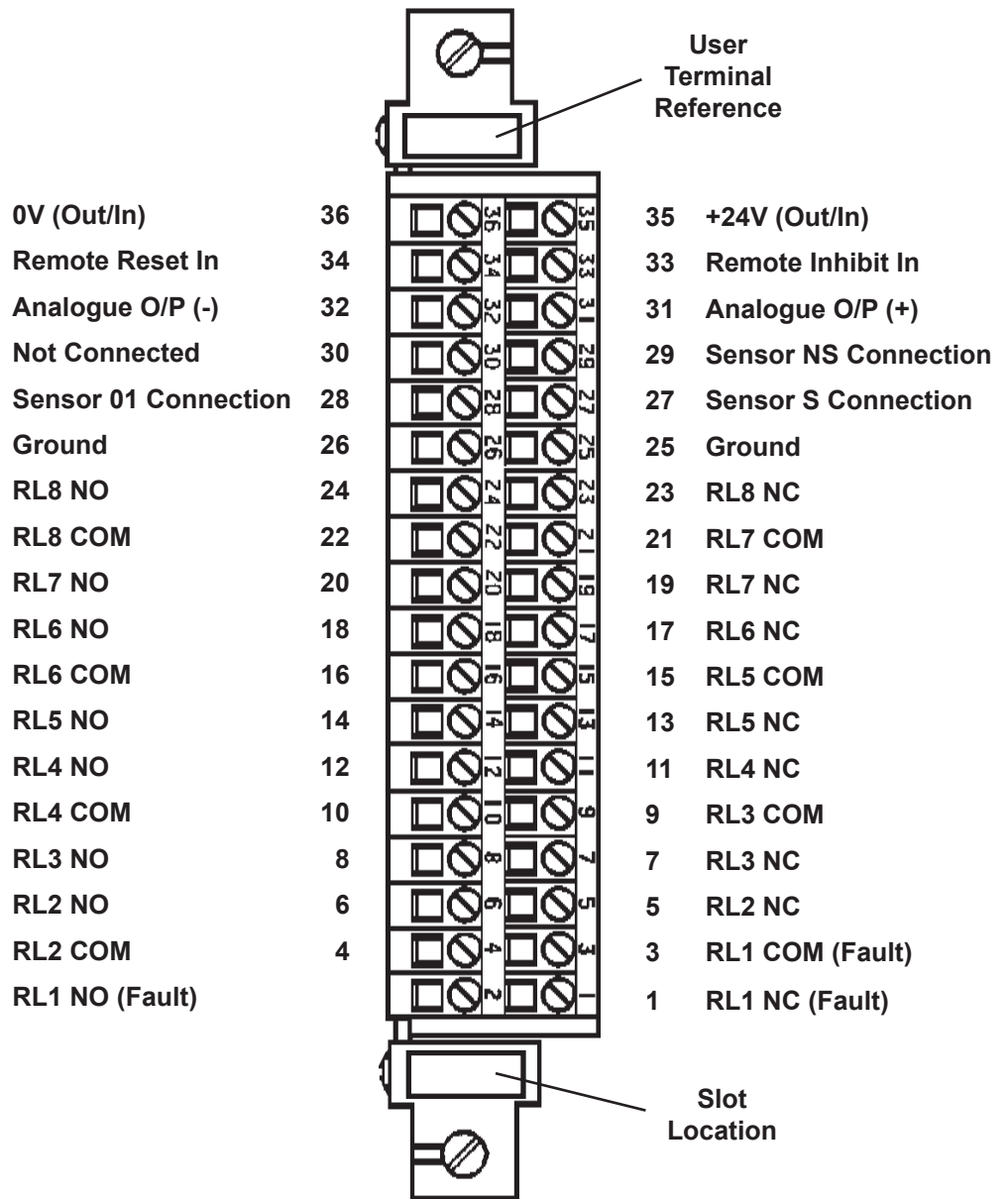

NC = Normally Closed. NO = Normally Open. COM = Common.

Relay contact conditions refer to the no power state of the relay.

## CHAPTER 2 - SYSTEM DESCRIPTION

### 6. ENGINEERING CARD

The Engineering Card (Part Number 05701-A-0361) is used on a System 57 rack to provide a common interface that enables the user to perform all the required functions to commission and operate each fitted control card.

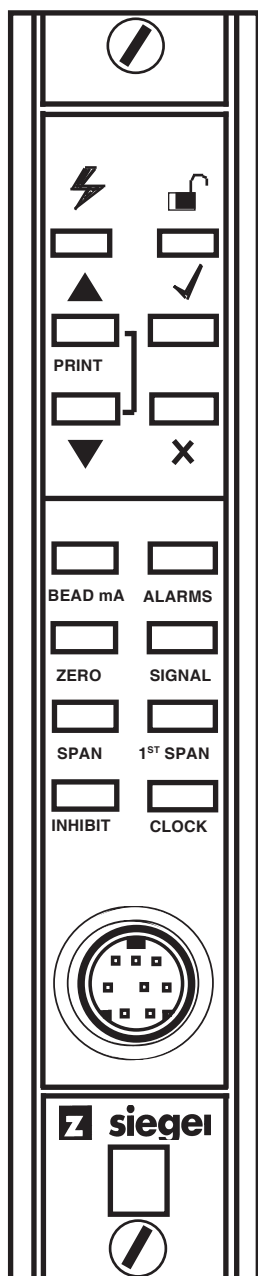

The front panel is fitted with a series of tactile push-buttons for the operation of various functions, LEDs to provide rack power and communications status and a mini DIN socket for the connection of a serial printer, computer or an engineering key. The Engineering Key is used to unlock functions that can alter the operation of a control card.

The Engineering Card is always fitted into the right-hand slot of the rack and provides:

- a. Routing of the 24V dc input from the DC Input Card to the backplane of the rack.
- b. A backplane serial communications controller and monitor.
- c. A time and date reference.
- d. An RS232 external engineering interface.
- e. Depending upon the security level, the operation of the following rack facilities:
  - Catalytic sensor head current monitoring and adjustment.
  - Alarm set point checking, adjustment and testing.
  - Sensor signal zero adjustment.
  - Sensor signal span adjustment and setting of sensor life monitoring values.
  - Sensor line monitoring.
  - Enabling of control card alarm inhibit.
  - Checking and adjustment of the system clock.
- f. Self validation of the operation of its circuit components, software operation and the backplane communications.



---

## CHAPTER 2 - SYSTEM DESCRIPTION

---

One of four optional modules may be fitted to the Engineering Card:

a. Master Alarm Update Module

This facility provides an indication when a new alarm occurs on any channel in the rack, even if a previous alarm condition already exists.

b. Event Printing Module

This facility provides time stamped reporting of alarm and fault events as they occur and system status at predetermined regular intervals.

c. Modbus Interface Module RS422/485

This facility provides for digital communication between the System 57 Control System and an external computer system using the RS422/485 serial data format and the Modbus communication protocol.

d. Modbus Interface Module RS232

This facility provides for digital communication between the System 57 Control System and an external computer system using the RS232 serial data format and the Modbus communication protocol.

---

# CHAPTER 2 - SYSTEM DESCRIPTION

---

## 7. DC INPUT CARD

### 7.1 General

The dc power to the rack normally enters the sub-rack via the DC Input Card (Part Number 05701-A-0325). This power may be supplied by the user from an external nominal 24V dc supply. The dc supply is routed through the Engineering Card and sub-rack back plane to all cards in the rack and is protected by a fuse on the DC Input Card. There is a two part terminal block, TB1, to aid removal of the card without disconnecting each of the connected wires.

If required, a stand-by backup battery supply may also be connected to the auxiliary dc input connections.

The PSU and AUX connections are isolated from each other by diodes.

The DC Input Card also provides RFI filtering and reverse polarity protection.

# CHAPTER 2 - SYSTEM DESCRIPTION

## 7.2 Rear Access Connections

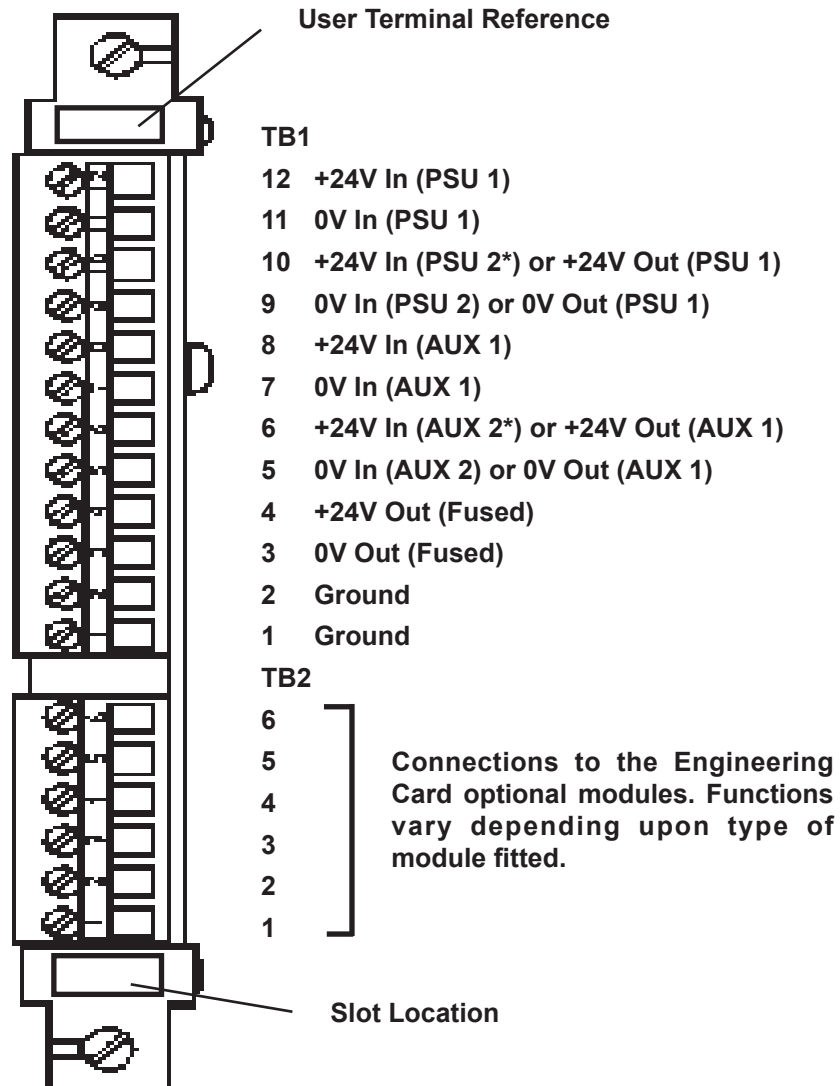

\* PSU 1 and PSU 2 (and AUX 1 and AUX 2) must be compatible with parallel connection.

*Note: For high integrity systems it is possible to connect the dc power direct to individual relay cards.*

# CHAPTER 2 - SYSTEM DESCRIPTION

## 7.3 Front Access Connections

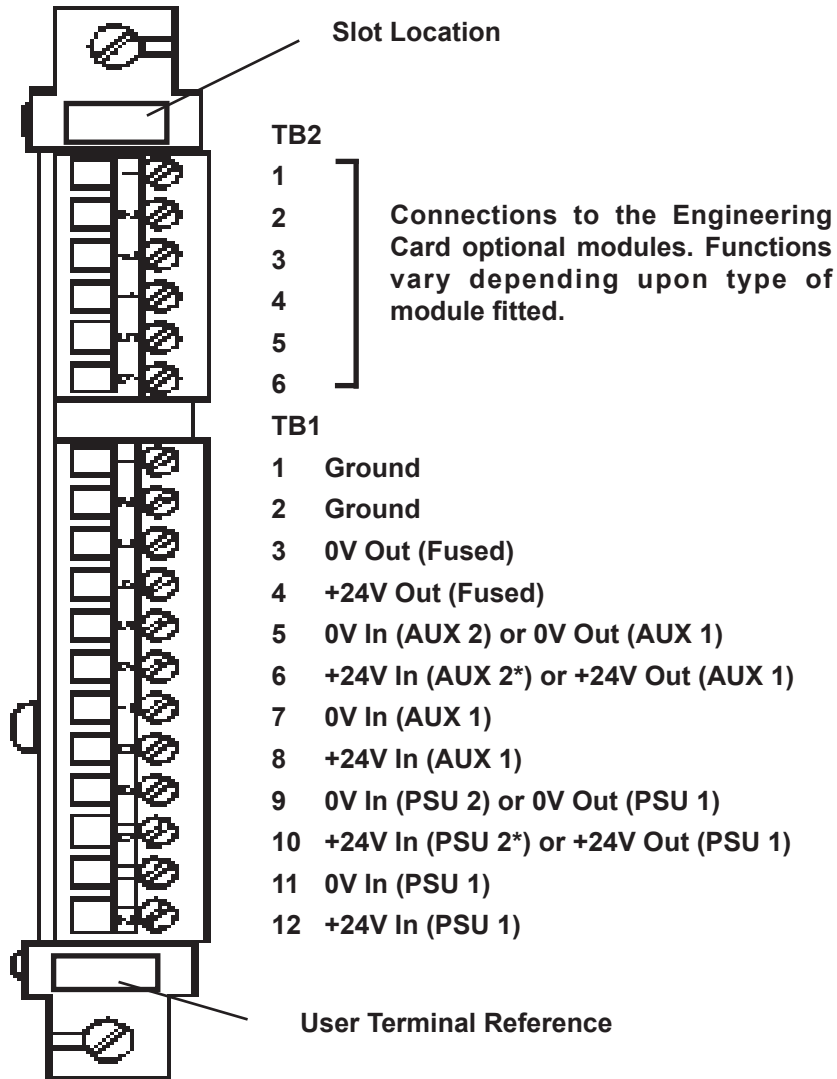

\* PSU 1 and PSU 2 (and AUX 1 and AUX 2) must be compatible with parallel connection.

*Note: For high integrity systems it is possible to connect the dc power direct to individual relay cards.*

---

# CHAPTER 2 - SYSTEM DESCRIPTION

---

## 8. AC TO DC POWER SUPPLY UNITS

### 8.1 Types of Power Supply Unit

There are two types of AC to DC power supply units:

- a. 8-Way AC to DC Power Supply Unit (Part Number 05701-A-0406)

A 1U high half width 19 inch rack mounted unit that contains a single 50W Switched Mode AC to DC Power Supply Module.

- b. 16-Way AC to DC Power Supply Unit (Part Number 05701-A-0405)

A 1U high 19 inch rack mounted unit that contains a single 50W Switched Mode AC to DC Power Supply Module.

Both power supply units will operate from an 85V to 264V, 47Hz to 440Hz ac supply, or a 110V to 340V dc supply (Refer to Honeywell Analytics for information on dc supplies).

### 8.2 Power Supply Unit Upgrades

Both power supply units are provided with internal connections to enable a power upgrade to 100W by the addition of a second 50W Switched Mode AC to DC Power Supply Module (Part Number 05701-A-0440).

A second sub-unit (Part Number 05701-A-0441) can be fitted to the basic 16-way power supply unit if more than 100W is required to operate the system. The additional sub-unit will contain a 50W Switched Mode AC to DC Power Supply Module as standard and will therefore give an additional 50W of available power. If required a further 50W Switched Mode AC to DC Power Supply Module (Part Number 05701-A-0440) can be added to this second sub-unit to bring the power availability up to 200W.

The switched mode power supply modules used are fully overload protected and are designed to be connected together.

### 8.3 Power Supply Connections

The input ac power supply is connected via a three core cable at the rear of each unit.

The nominal 24V dc output supply is connected via a twin core cable at the rear of each unit.

# CHAPTER 2 - SYSTEM DESCRIPTION

## 8.4 8-Way AC to DC Power Supply Unit Layout

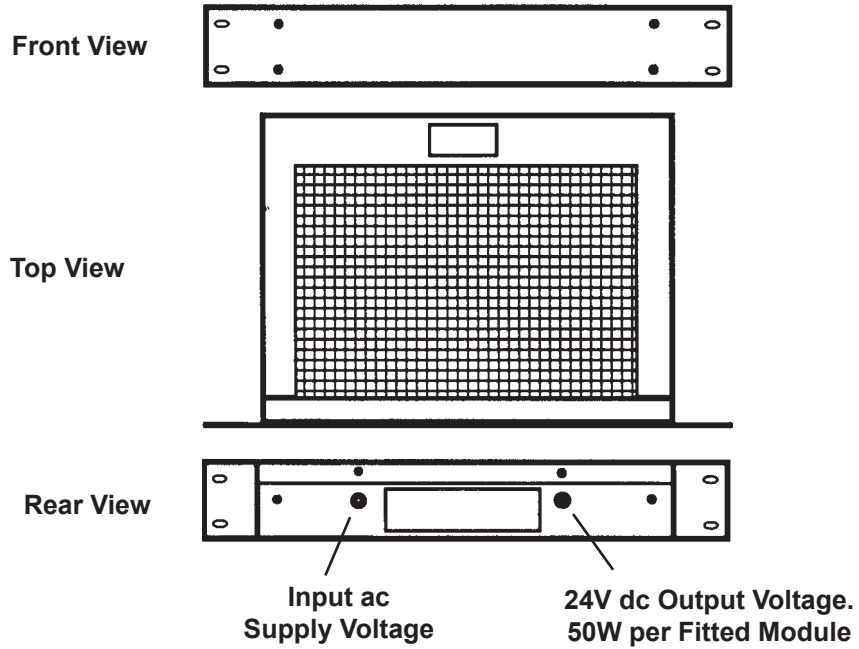

## 8.5 16-Way AC to DC Power Supply Unit Layout

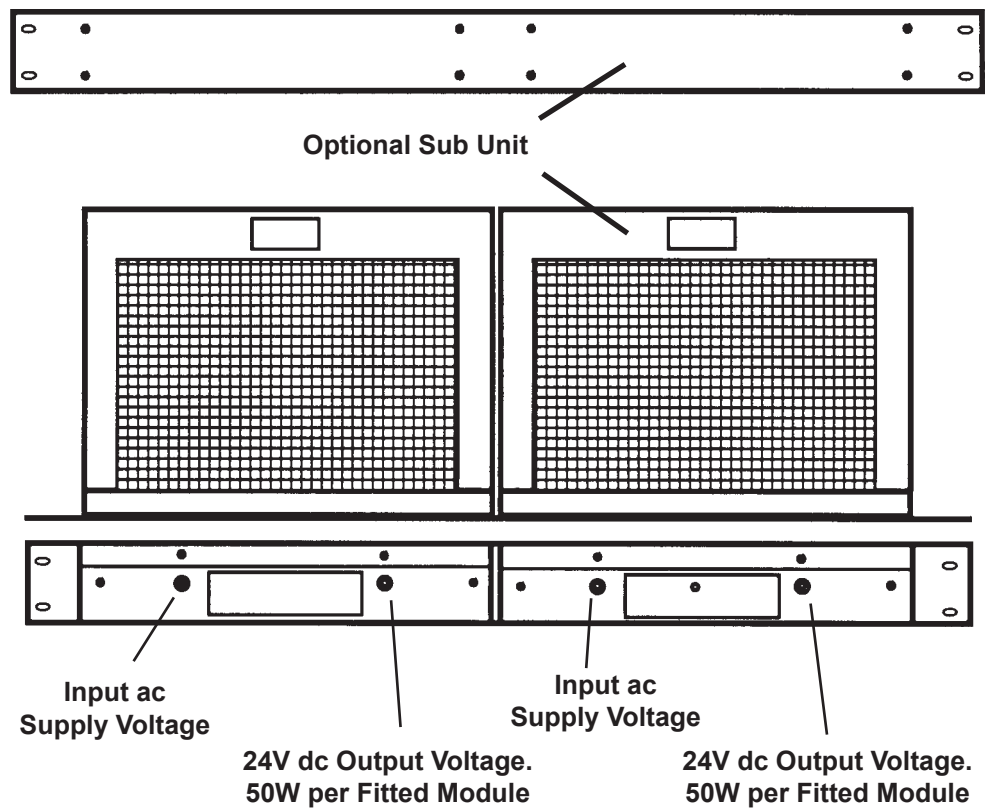

# CHAPTER 2 - SYSTEM DESCRIPTION

## 8.6 50W Sub-Unit Layout

The 50W Sub-unit is fitted with a single 50W Switched Mode AC to DC Power Supply Module as shown below:

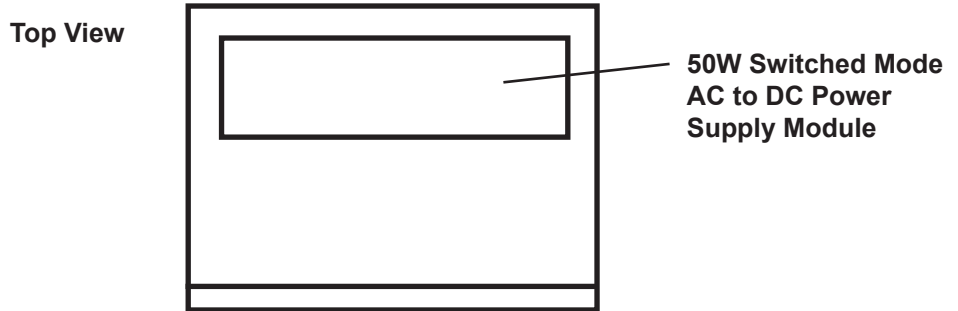

This type of unit is identified on the identification label as follows:

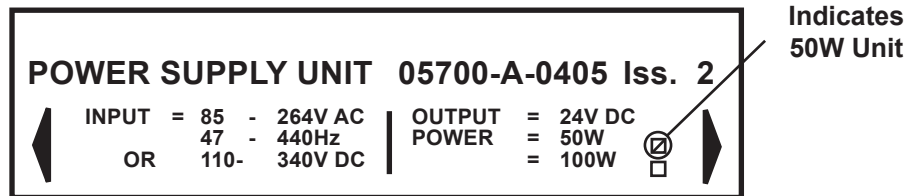

## 8.7 100W Sub-Unit Layout

The 100W Sub-unit is a 50W Sub-unit with an additional 50W Switched Mode AC to DC Power Supply Module fitted as shown below:

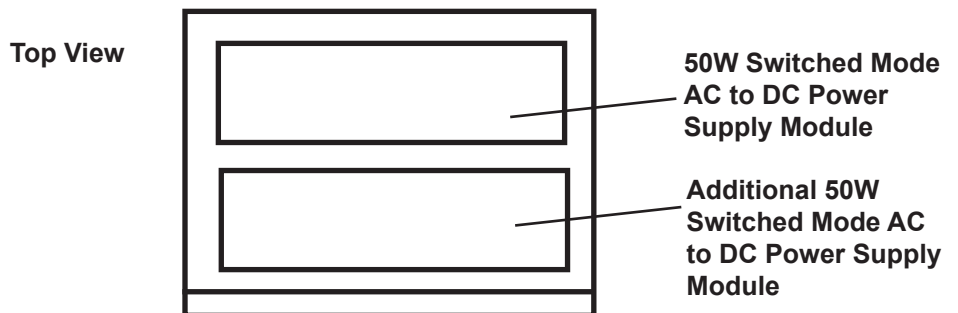

This type of unit is identified on the identification label as follows:

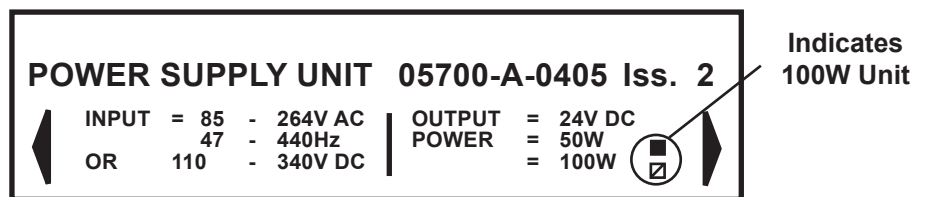

---

# CHAPTER 2 - SYSTEM DESCRIPTION

---

## 9. FRONT PANEL BLANKING PANEL

Matching blank front panels are available for fitting to the rack in all unused single channel control card spaces.

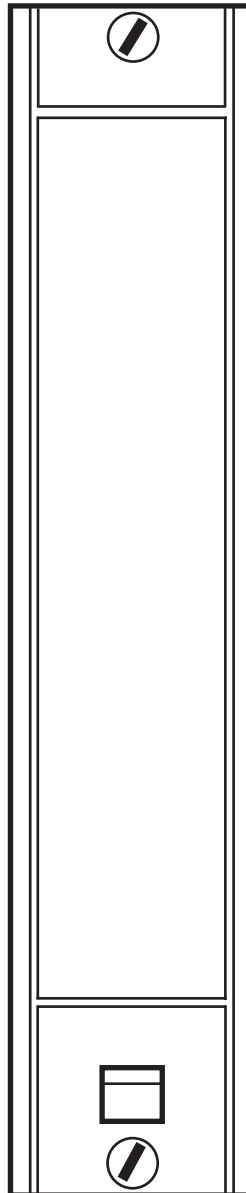



---

# CHAPTER 2 - SYSTEM DESCRIPTION

---

---

# **CHAPTER 3 CONTROLS AND FACILITIES**

---

## **5701 SERIES CONTROL SYSTEM CHAPTER 3 CONTROLS AND FACILITIES**

---

# CHAPTER 3 CONTROLS AND FACILITIES

---

## CONTENTS

Section	Page
1. INTRODUCTION	3-3
2. SINGLE CHANNEL CONTROL CARD	3-8
2.1 General	3-8
2.2 Liquid Crystal Display	3-9
2.3 LEDs	3-11
2.4 Reset/Select Push-button	3-12
2.5 Extraction Slot	3-13
2.6 Display Label and Cover	3-13
3. ENGINEERING CARD	3-14
3.1 General	3-14
3.2 LED Indicators	3-14
3.3 Engineering Push-buttons	3-15

---

# CHAPTER 3 CONTROLS AND FACILITIES

---

## 1. INTRODUCTION

The 5701 Series Control System is equipped to provide the operational and engineering facilities necessary to fully maintain a system of gas detection equipment.

Each control card within a rack system displays a sensor reading, alarm status and condition of that channel.

Further information can be gathered and, depending on the security status, certain settings can be adjusted by means of an Engineering Card fitted to the rack.

The relay outputs of the system are configured to provide a range of output alarm functions as follows:

a. Fault Alarm

The fault alarm activates when a fault is detected in the control card or associated sensor and is not user configurable. In addition the FAULT LED will be illuminated.

b. Inhibit Alarm

The inhibit alarm activates when the system alarms are inhibited for any reason and is not user configurable. In addition the INHIBIT LED will be illuminated.

c. A1, A2 and A3 Level Alarms

The A1, A2 and A3 level alarms are activated when the level of gas being measured crosses the preconfigured alarm threshold. In addition the relevant LED will be illuminated.

d. STEL Alarm (Short Term Exposure Limit)

The STEL alarm will be activated when the time weighted average concentration of a toxic gas, usually averaged over 10, 15 or 30 minutes, crosses a preconfigured threshold. When active STEL will be shown on the message display of the control card. For certain relay cards and configurations, the alarm LED associated during setup to the STEL alarm will be illuminated.

---

# CHAPTER 3 CONTROLS AND FACILITIES

---

e. LTEL Alarm (Long Term Exposure Limit).

The LTEL alarm will be activated when the time weighted average concentration of a toxic gas, usually averaged over 8 hours, crosses a preconfigured threshold. When active LTEL will be shown on the message display of the control card. For certain relay cards and configurations, the alarm LED associated during setup to the LTEL alarm will be illuminated.

f. Rate Alarm (Version 2V<sub>x</sub> Software only)

The rate alarm predicts the future gas concentration by monitoring the rate of rise of the sensor signal and provides an early alarm indication before the sensor signal reaches the next level alarm set point.

g. Individual Alarm

An individual alarm is caused by the input to an individual control channel crossing a preconfigured threshold and is not related to any other control channel. The relevant LED (A1, A2, A3, Fault, Inhibit) will illuminate on the control card with the alarm condition.



**CAUTION\***

Depending upon the configuration, control cards configured for Zoned, Master or Voted alarms may not give individual alarm outputs.

h. Zoned Alarm\*

A zoned alarm is caused by the input to any control channel, from a sensor in a designated area, crossing a preconfigured threshold. The relevant LED (A1, A2, A3, Fault, Inhibit) will illuminate on the control card with the alarm condition and also on the control card designated the Zone Master Card (unless it is fitted with a High Integrity Relay Card).

i. Master Alarm\*

A master alarm is caused by the input to any designated control channel within a single rack crossing a preconfigured threshold. The relevant LED (A1, A2, A3, Fault, Inhibit) will illuminate on the control card with the alarm condition and also on the control card designated the Master Card (unless it is fitted with a High Integrity Relay Card).

---

# CHAPTER 3 CONTROLS AND FACILITIES

---

j. Voted Alarm\*

A voted alarm is caused by the simultaneous presence of an identical alarm on more than one control channel within a preconfigured group. The relevant LED (A1, A2, A3, Fault, Inhibit) will illuminate on the control cards with the alarm condition and also on the control card designated the Vote Master Card (unless it is fitted with a High Integrity Relay).

Vote compensation (Version 2V6 and above Software only) may be applied to the voted alarm output operation by selecting one of the following configurations:

- a. No compensation.
- b. Faults counted as alarms.
- c. Faults and inhibits counted as alarms.
- d. Vote count reduction on faults.
- e. Vote count reduction on faults and inhibit.

Vote compensation is useful to ensure that sensors in fault (or inhibit) do not prevent voted alarm outputs.

k. Update Alarm (Version 2V<sub>x</sub> Software only)

The update alarm facility provides a common alarm indication whenever a new alarm occurs, even if a previous alarm condition exists. The update alarm can be configured to operate on a single channel or on a grouped alarm. eg. master or zoned.

The update alarm is especially useful in systems configured with only master or group/zone relays, where the occurrence of subsequent alarms will not cause further relay output compared to that caused by the initial alarm.

The relevant LED (A1, A2, A3, Fault, Inhibit) will illuminate on the control card with the alarm condition as described in section 2.3. When relays are used for signalling update alarms, no other alarms or messages must be allocated to them. Configuration of update messages for “inhibit” should be avoided.

l. Rising Alarm

A rising alarm is caused by a rising level of the parameter being measured crossing a preconfigured threshold and will also cause the associated alarm LED to illuminate.

---

# CHAPTER 3 CONTROLS AND FACILITIES

---

m. Falling Alarm

A falling alarm is caused by a falling level of the parameter being measured crossing a preconfigured threshold and will also cause the associated alarm LED to illuminate.

n. Latched Alarm

A latched alarm is an alarm that will remain active even though the level monitored no longer crosses the alarm threshold. The alarm LED will remain lit until the alarm reset is operated.

o. Non-latched Alarm

A non-latched alarm is an alarm that only remains active while the level being monitored crosses the alarm threshold. The alarm LED will remain lit while the alarm level remains but will automatically be reset when the level monitored no longer crosses the alarm threshold.

p. Normally Energised

A normally energised relay is activated when the power is removed from it, (eg. in the event of a system power failure). The LEDs will illuminate when an alarm or fault condition occurs irrespective of the relay configured state.

q. Normally De-energised

A normally de-energised relay is activated when the power is applied to it, (eg. in the event of an alarm condition). The LEDs will illuminate when an alarm or fault condition occurs irrespective of the relay configured state.

r. Time Delay Alarms (Version 2V<sub>x</sub> Software only)

The operation in response to alarm events of certain relays may be modified by applying a delay function to the relays. Time delay functions are available to delay the activation of a relay for a short period after an alarm event occurs and/or to maintain relay activation for a period after the alarm event has cleared. The time delay facilities are available for relays RL2 to RL8 of the High Integrity Relay Card only.

The time delay function is useful to prevent spurious alarms and to ensure appropriate minimum operating times for external electrical apparatus connected to the relay.

# CHAPTER 3 CONTROLS AND FACILITIES

## Control Card Versions

Since the original launch of System 57 several new features have been added to enhance the capabilities of the 5701 Control Card. The key features for each software version are illustrated in the following table. Note that the software fitted to existing cards cannot be upgraded, however all versions of software and hardware are fully backward compatible so new cards can be incorporated into existing systems without difficulty.

Function	Control Card and Software Versions				
	Mark I		Mark II		
	0v7	1v1	2V4	2V5	2V6
Fault Alarm	Yes	Yes	Yes	Yes	Yes
Inhibit Alarm	Yes	Yes	Yes	Yes	Yes
A1, A2, A3 Alarm	Yes	Yes	Yes	Yes	Yes
STEL/LTEL Alarm	No	Yes	Yes	Yes	Yes
30 Minute STEL	No	No	Yes	Yes	Yes
Rate Alarm	No	No	Yes	Yes	Yes
Zoned Alarm	Yes	Yes	Yes	Yes	Yes
Master Alarm	Yes	Yes	Yes	Yes	Yes
Voted Alarm	Yes	Yes	Yes	Yes	Yes
Vote Compensation	No	No	No	No	Yes
Update Alarm	No	No	Yes*	Yes*	Yes*
Time Delay Relays	No	No	Yes	Yes	Yes
Standard Relay Cards	Yes	Yes	Yes	Yes	Yes
High Integrity Relay Cards	No	No	Yes*	Yes*	Yes
Fault Warm-Up	No	No	Yes	Yes	Yes
MODBUS Compatible	No	Yes**	Yes	Yes	Yes
Complex Alarms include 5704	No	No	Yes	Yes	Yes
*Special configuration criteria apply, consult Honeywell Analytics or your local distributor for more details.					
**Restricted functionality only, consult Honeywell Analytics or your local distributor for more details.					



# CHAPTER 3 CONTROLS AND FACILITIES

## 2. SINGLE CHANNEL CONTROL CARD

### 2.1 General

The Single Channel Control Card provides the necessary power supplies to the associated sensor and conditions the incoming sensor signal. The received sensor signal is then processed by the microprocessor and the resultant value and any necessary alarm action, depending on the channel configuration, is carried out.

The channel card front panel can be subdivided into five areas:

- Display Label and Cover.
- LCD Display.
- Alarm LEDs.
- Reset/Select Push-button.
- Extraction Slot.

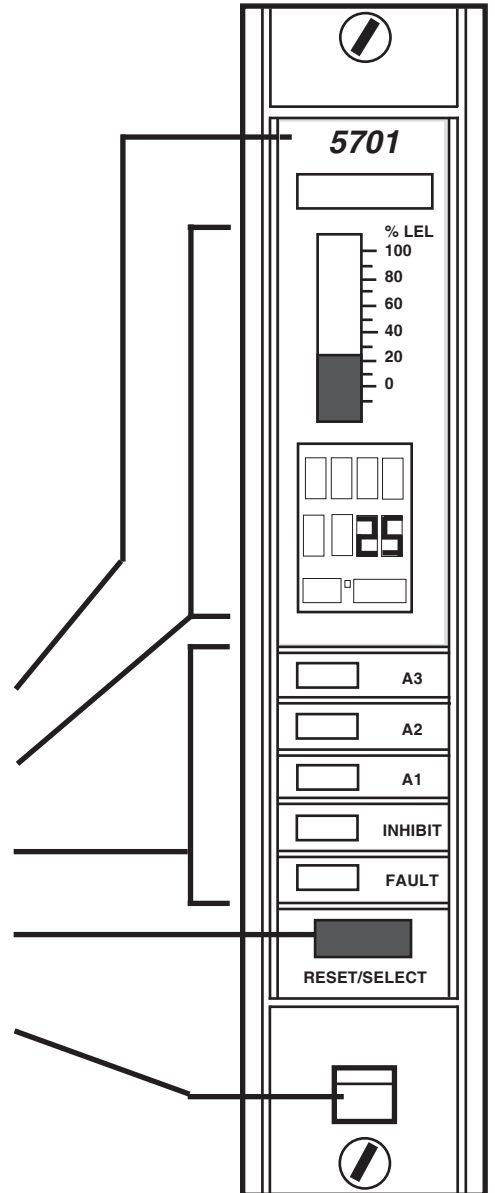

# CHAPTER 3 CONTROLS AND FACILITIES

## 2.2 Liquid Crystal Display

### 2.2.1 General

The LCD provides a display of the connected sensor reading and its status, or if maintenance is being carried out on the sensor, information on the sensor set points and calibration data.

The display can be divided into four parts:

- Analogue Display.
- Message Display
- Digital Display.
- Icon Display.

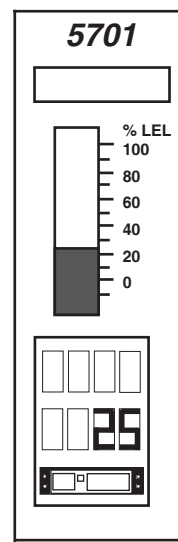

### 2.2.2 Analogue Display

This consists of 25 segments providing an indication of the sensor gas reading in the form of an analogue bar graph which covers the sensor range between -10% and +110% fsd.

There are two possible modes of operation:

- a. Solid in which the segments fill the area between zero and the actual gas reading.
- b. Single Line in which a single segment indicates the actual gas reading.

Each of these modes can be operated as either a rising or falling display. A peak reading facility is available which maintains a segment at the highest, or lowest, gas value obtained by the sensor since the previous peak reading reset. This is a useful recording tool for the behaviour of the connected sensor.

The default mode of operation is solid current gas reading display with a peak reading facility.

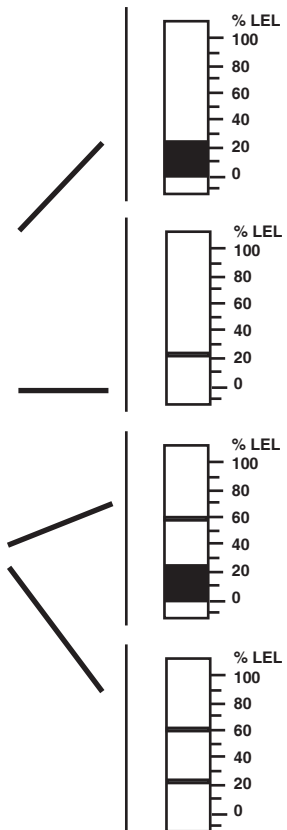

---

# CHAPTER 3 CONTROLS AND FACILITIES

---

## 2.2.3 Digital Display

The digital display is a four character, seven segment display which provides either an indication of the sensor gas reading or a value relating to a function selected from the Engineering Card.

Depending on the sensor range and the configuration setting, the digital display shows a gas value to either no decimal place (the default setting) or to one decimal place.

## 2.2.4 Message Display

The message display consists of a four character, 14 segment display which provides intelligent reporting of the sensor status or information on a selected engineering function. For control cards fitted with the high integrity relay outputs performing master, zone or voted alarms, the alarm state will also be indicated as follows:

BEAM	-	Beam Blocked Alarm
MSTR	-	Master Alarm
ZONE	-	Zoned Alarm
VOTE	-	Voted Alarm

In the case of an Update alarm the cause of the update is indicated as follows:

-FT-	-	Fault Alarm
-IN-	-	Inhibit Alarm
-A1-	-	A1 alarm
-A3-	-	A2 alarm
-A3-	-	A3 alarm
-ST-	-	STEL alarm
-LT-	-	LTEL alarm
-RT-	-	Rate alarm

## 2.2.5 Icon

The icon provides a simple indication that the display is functioning and changes when the channel card is selected for operation with the Engineering Card.

**Normal Operation**



**Selected**



---

# CHAPTER 3 CONTROLS AND FACILITIES

---

## 2.3 LEADS

Five LEDs on the front panel of the control card indicate the operational status of the channel as follows:

a. **FAULT** - Amber LED

The fault LED provides an indication in the event of a sensor hardware failure, if the sensor signal is outside pre-defined limits or if the channel card has detected a hardware or software fault.

b. **INHIBIT** - Amber LED

The inhibit LED indicates when the channel is in the inhibit condition. This condition can be selected manually and remotely, or occurs automatically:

- during start-up for a pre-defined period of approximately 30 seconds,
- when carrying out certain engineering functions such as zero, span, 1st span and alarm test.
- Depending upon the configuration, the control card may enter the inhibit mode for a short period of time immediately after a fault condition is cleared

During the inhibit condition, the channel card will continue to read the gas sensor reading, however, no action is taken in the event of an alarm condition being exceeded.

c. **A1** - Red LED

The A1 LED indicates that the preset first level gas alarm has been exceeded. This alarm will not function in the event of either a fault or inhibit condition being active.

d. **A2** - Red LED

The A2 LED indicates that the preset second level gas alarm has been exceeded. This alarm will not function in the event of either a fault or inhibit condition being active.

e. **A3** - Red LED

The A3 LED indicates that the preset third level gas alarm has been exceeded. This alarm will not function in the event of either a fault or inhibit condition being active.

---

# CHAPTER 3 CONTROLS AND FACILITIES

---

## 2.4 Reset/Select Push-button

The front panel **RESET/SELECT** push-button provides four functions depending upon how it is operated:

a. Alarm Reset

The **RESET/SELECT** push-button, when pressed momentarily, resets any latched alarm, non active alarms, faults, warning or information messages, clears the display peak reading indicator and will acknowledge an update if such a condition is present.

*Note: 'Non active alarms' describe the occasion where the alarm condition has cleared but the alarm is still indicated due to latched information. For non-latched setups the indicated alarms will clear automatically when the alarm condition clears.*

b. Channel Select

The **RESET/SELECT** push-button, when pressed for approximately 1.5 seconds, selects the control card for operations controlled from the Engineering Card.

c. Extended Reset

The **RESET/SELECT** push-button, when pressed continuously for five seconds:

- i. Clears the channel maximum and minimum gas readings.
- ii. Resets any active short term (STEL) and long term (LTEL) exposure alarms clearing the timer to zero.
- iii. For active time delay functions, activates any relay with impending trigger and clears any relay being held.

d. Channel Deselect

The **RESET/SELECT** push-button, when pressed momentarily while a control card is selected, deselects the control card from the Engineering Card functions.

*Note: The control card may also be deselected by pressing the **X** key.*

# CHAPTER 3 CONTROLS AND FACILITIES

## 2.5 Extraction Slot

An extraction tool is used in conjunction with the extraction slot, just below the select push-button, to remove the card from the rack. The extraction tool is provided as part of the Key Kit (05701-A-0550) supplied with each rack assembly.

The card is removed by first unscrewing the two card securing screws, one at the top of the card and the other at the bottom of the card, and then hooking the extraction tool into the extraction slot and then gently pulling the card out of the rack.

## 2.6 Display Label and Cover

A clear perspex cover clips to the front panel and retains the label which provides identification of the control card type, sensor scale, LED and push-button functions.

Two different label colours are used:

- a. Grey/Blue - Control cards fitted with Catalytic Sensor Drive Modules.
- b. Violet - Control cards fitted with 4 - 20mA Sensor Drive Modules.

The perspex cover is removed by first removing the control card from the rack and then locating a small hole on the inside of the front panel just above the LCD display. A blunt object, such as a screwdriver, is then pushed through the hole to unclip the perspex cover.

A small recess in the perspex cover allows a label to be inserted to indicate the channel tag name or gas type.

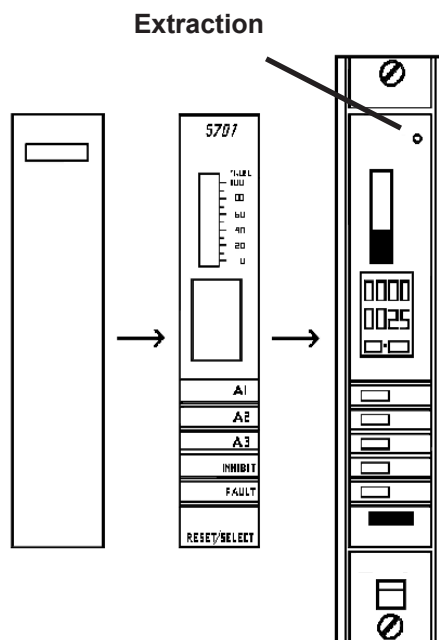

# CHAPTER 3 CONTROLS AND FACILITIES

## 3. ENGINEERING CARD

### 3.1 General

The Engineering Card provides facilities to allow each control card to be interrogated and to allow normal maintenance functions such as calibration to be carried out. It also acts as a connecting point for the engineering interface which allows each card to be configured.

### 3.2 LED Indicators

Two indicators at the top of the front panel of the Engineering Card indicate the operational status of the card:

#### 3.2.1 ⚡ - Green LED

A continuously illuminated LED indicates that the correct dc power is connected to the rack via the DC Input Card.

A flashing LED at approximately two second intervals, indicates a low dc power input level.

A flashing LED at approximately 0.5 second intervals, indicates a hardware fault.

#### 3.2.2 🔒 - Red LED

Provides an indication of the operation of the Engineering Card communications status as follows:

**Off:** Engineering Card functioning correctly and the engineering functions are locked. Operators functions are operational to allow the checking of various control card settings.

**On:** Engineering Card functioning correctly and the engineering functions are unlocked enabling changes to be made to the operation of a selected control card.

**Flashing:** Indicates that a control card has been withdrawn from the rack, there is a communications error or that an external PC running the engineering interface software is communicating with the control cards.

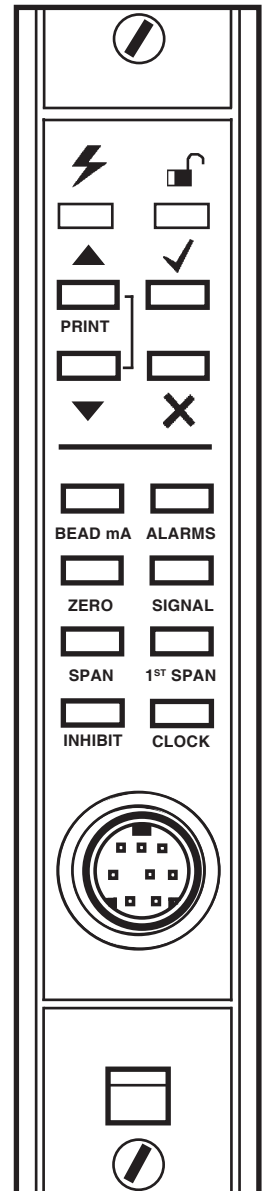

*Note: To reset this indication, insert the Engineering Key briefly and remove it again.*

---

# CHAPTER 3 CONTROLS AND FACILITIES

---

## 3.3 Engineering Push-buttons

### 3.3.1 General

The Engineering Card push-buttons control various functions depending on the type of control card fitted and whether the Engineering Key is fitted.

### 3.3.2 Up Push-button (▲)

When the up push-button (▲) is operated, it increases the value of those functions that can be adjusted.

### 3.3.3 Down Push-button (▼)

When the down push-button (▼) is operated, it decreases the value of those functions that can be adjusted.

### 3.3.4 Operation of the Up and Down Push-buttons Simultaneously

This operation can only be used if a serial printer is connected to the rack. When the up (▲) and down (▼) push-buttons are operated simultaneously a print out command is selected of the control card configuration and status.

### 3.3.5 Accept Push-button (✓)

When the accept push-button (✓) is operated during any of the engineers functions, this button confirms adjustments that have been made and then cancels that function.

### 3.3.6 Reject Push-button (✕)

When operated during any of the engineers functions and providing the accept (✓) push-button has not been operated, the reject push-button (✕) cancels adjustments that have been made. This push-button is also used to deselect a selected function.

### 3.3.7 BEAD mA Push-button

When the **BEAD mA** push-button is operated, the display of the selected Catalytic Control Card provides an indication of that card's sensor head current.

Adjustments to this current can also be made if the Engineering Key is fitted to the Engineering Card.



---

# CHAPTER 3 CONTROLS AND FACILITIES

---

## 3.3.8 ALARMS Push-button

When the **ALARMS** push-button is operated, the display of the selected control card provides an indication of that card's level and type (rising or falling) of each alarm level (A1, A2, A3, STEL, LTEL).

If the Engineering Key is fitted to the Engineering Card, adjustments can be made to the alarm levels, within pre-defined limits, and additional test facilities become available. This facility allows each alarm operation to be checked and, if required, its associated output relay to be exercised.

## 3.3.9 SIGNAL Push-button

When the **SIGNAL** push-button is operated, the display of the selected control card provides an indication of that cards sensor signal as follows:

- a. 4 - 20mA Control Card - Loop current in mA.
- b. Catalytic Control Card - Catalytic bridge output (sensitivity) in mV.

## 3.3.10 ZERO Push-button

The **ZERO** push-button can only be used when the Engineering Key is fitted to the Engineering Card and is used to calibrate the zero point of the selected control card.

## 3.3.11 SPAN Push-button

The **SPAN** push-button can only be used when the Engineering Key is fitted to the Engineering Card and is used to calibrate the span point of the selected control card.

## 3.3.12 1ST SPAN Push-button

The **1ST SPAN** push-button can only be used when the Engineering Key is fitted to the Engineering Card and is used to calibrate the span point of a new catalytic sensor fitted to a selected catalytic control card.

This function is used to provide an indication, in conjunction with subsequent normal span adjustments, of the output sensitivity of a catalytic sensor and to automatically indicate poisoning or loss of sensor performance.

## 3.3.13 CLOCK Push-button

When the **CLOCK** push-button is operated, the display of the selected control card provides an indication of the time and date of the rack clock.

---

# CHAPTER 3 CONTROLS AND FACILITIES

---

The rack clock is located in the Engineering Card, however since the Engineering Card has no display, a control card must be selected to enable the time and date to be displayed. It does not matter which control card is selected.

If the Engineering Key is fitted to the Engineering Card, the time and date can be adjusted.

### 3.3.14 INHIBIT Push-button

When the **INHIBIT** push-button is operated, the selected control card is placed in the inhibit mode. This prevents the operation of any configured relay output alarm functions.

Inhibit can only be used if the Engineering Key is fitted to the Engineering Card, however, if the Engineering Key is subsequently removed the selected control card remains in the inhibit mode.

### 3.3.15 Engineering Serial Port

The Engineering Serial Port is a miniature DIN socket which provides three functions:

- a. Connection point for the Engineering Key to unlock the engineers functions.
- b. Connection point for the External Engineering Interface which allows each control card to be configured by an external PC running the configuration software.
- c. Connection point for a serial printer which can be used to provide a hard copy of the control card configuration data and status.

The Engineering Serial Port and its Engineering Key are shown below:

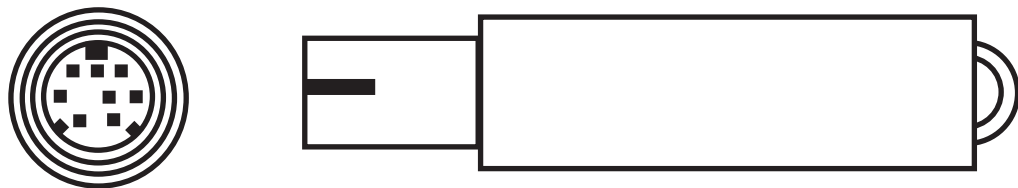

---

# CHAPTER 3 CONTROLS AND FACILITIES

---

---

# **CHAPTER 4 - INSTALLATION INSTRUCTIONS**

---

**5701 SERIES  
CONTROL SYSTEM  
CHAPTER 4  
INSTALLATION INSTRUCTIONS**

# CHAPTER 4 - INSTALLATION INSTRUCTIONS



## WARNING

For installations in the EU, refer to EN 60079-14, 'Explosive atmospheres - Electrical installations design, selection and erection.'

Additionally, the code of practice regarding Selection, installation, use and maintenance of apparatus for the detection and measurement of combustible gases or oxygen must be complied with. Refer to EN 60079-29-2.

The above standards apply to the System 57 since the **SENSORS** may be installed in potentially hazardous atmospheres.

In addition, appropriate local or national regulations shall be used.”

## IMPORTANT NOTICES

1. Honeywell Analytics Limited can take no responsibility for installation and/or use of its equipment if this is not done in accordance with the appropriate issue and/or amendment of the manual.
2. The user of this manual should ensure that it is appropriate in all details to the exact equipment to be installed and/or operated. If in doubt, the user should contact Honeywell Analytics Limited for advice.
3. The System 57 cards contain no user serviceable parts. Refer all servicing to qualified service personnel.
4. When inserting or removing system components ensure that the power is switched off. Failure to do this may result in damage to the system.

---

# CHAPTER 4 - INSTALLATION INSTRUCTIONS

---

<b>CONTENTS</b>		
Section		Page
1.	INTRODUCTION	4-5
2.	UNPACKING	4-6
3.	LOCATION	4-7
4.	CABLING	4-8
5.	POWER REQUIREMENTS	4-9
6.	VENTILATION	4-11
7.	PRELIMINARIES	4-12
8.	CABINET INSTALLATION	4-13
9.	PANEL INSTALLATION	4-16
10.	RACK INSTALLATION	4-18
11.	SENSOR INSTALLATION	4-19
11.1	General	4-19
11.2	Sensor Line Resistance	4-19
11.3	Cable Resistance Guide	4-21
11.4	Catalytic Sensors	4-21
11.5	4-20mA Loop Powered Sensors:	4-22
11.6	4-20mA Transmitters	4-22
12.	CONTROL CARD SENSOR DRIVE MODULE CONFIGURATION	4-23
12.1	General	4-23
12.2	Single Channel Control Card, Catalytic Input Link Settings	4-23
12.3	Single Channel Control Card, 4 - 20mA Input Link Settings	4-23

---

# CHAPTER 4 - INSTALLATION INSTRUCTIONS

---

13.	SENSOR CONNECTIONS	4-25
13.1	General	4-25
13.2	Catalytic Sensor Connections	4-25
13.3	4 - 20mA Loop Powered Sensor Connections	4-28
13.4	4 - 20mA Transmitter Connections	4-31
13.5	IS Series 2000 Toxic Transmitter Connections	4-56
14.	OUTPUT CONNECTIONS	4-61
14.1	Relay Outputs	4-61
14.2	Analogue Output	4-62
15.	REMOTE INPUT CONNECTIONS	4-65
16.	DC POWER CONNECTIONS	4-67
16.1	General	4-67
16.2	Individually Powered Control Cards	4-68
17.	AC TO DC POWER SUPPLY UNIT CONNECTIONS	4-69
18.	UPGRADING THE AC TO DC POWER SUPPLY UNITS	4-71
18.1	General	4-71
18.2	8-Way and 16-Way AC to DC Power Supply Unit Upgrade to 100W	4-74
18.3	16-Way AC to DC Power Supply Unit Upgrade to 150W or 200W	4-75

---

# CHAPTER 4 - INSTALLATION INSTRUCTIONS

---

## 1. INTRODUCTION

A summary of the System 57 controller installation procedures is shown below:

- a. Unpack and check the equipment.
- b. Identify a suitable location and check the cabling requirements.
- c. Confirm the power supply requirements.
- d. Install the Cabinet, 19" Mounting Frame or Panel Cutout as required.
- e. Fit the System 57 rack into the Cabinet, 19" Mounting Frame or Panel Cutout.
- f. Install the sensors and wire back to the System 57.
- g. Check, and if necessary reconfigure, the Single Channel Control Cards.
- h. Wire the sensors to the Field Interface/Relay Card terminal blocks.
- i. Wire the outputs from Field Interface/ Relay Card terminal blocks.
- j. Wire the power supply to the DC Input Card.

After installation is complete perform the commissioning procedures outlined in Chapter 5.

The following sections of this chapter provide a detailed explanation of the installation operations.



---

# CHAPTER 4 - INSTALLATION INSTRUCTIONS

---

## 2. UNPACKING

On receipt:

- a. Carefully unpack the equipment observing any instructions printed on or contained in the packaging.
- b. Check the contents for transit damage and against the packing note for deficiencies.
- c. Locate the configuration sheet supplied with the unit and confirm that each channel card type and settings are compatible with the proposed sensors.

---

# CHAPTER 4 - INSTALLATION INSTRUCTIONS

---

## 3. LOCATION

The control system must be installed in a safe area such as a control or equipment room. It must be installed in a vibration-free environment away from sources of heat, with adequate ventilation and protected from the weather.

There are two different System 57 rack configurations to accommodate either front or rear field wiring entry. Each configuration is available in half or full 19" width. The three most common mounting methods are:

a. 19" Mounting Frame

The System 57 19" 6U front and 3U rear access racks are compatible with the standard 19" (483mm) sub-rack format and may therefore be fitted into any suitable 19" mounting frame.

b. Cabinet

Wall mounting cabinets are available in two sizes to accommodate the 19" and half 19" 6U front access rack assemblies.

c. Panel

Alternatively all the racks are suitable for fitting directly into a panel cutout aperture.

Power supply units are available, in both 19" and half 19" 1U formats, for applications where an ac input power source is to be used. It is recommended that the power supply units are mounted directly above the System 57 rack.



### CAUTION

**3U rear access racks should always be supported at the rear of the unit to prevent distortion and excessive loading of the front flange plates.**

---

# CHAPTER 4 - INSTALLATION INSTRUCTIONS

---

## 4. CABLING

The field terminals on the Field Interface and Relay Cards accept up to 2.5mm<sup>2</sup> single or multi-stranded wire. Cables should be routed carefully to avoid physical and environmental hazards such as mechanical stress and high temperatures.

Sensor wiring should consist of a cable with an earthed outer shield and should be routed away from sources of interference such as ac power cables, motors, machinery etc. All sensor cabling is subject to a maximum cable length that is dependant upon the cable line resistance and sensor types.

The current ratings of the power and relay cables should always be higher than the worst case maximum load requirement.

All sensor field cables must be screened in order to ensure correct operation of the system and to meet European Standards for RFI and EMC. The cable screen of each sensor should be connected to the GROUND terminal of the appropriate Field Interface or Relay Card or another suitable ground point.

---

# CHAPTER 4 - INSTALLATION INSTRUCTIONS

---

## 5. POWER REQUIREMENTS

The System 57 operates from a nominal 24V (18V to 32V) dc power supply input which can be derived from various sources including the mains ac, via a separate ac to dc power supply unit, local plant dc supply and/or battery backup dc supply.

The power supply is applied to the System 57 via the DC Input Card which provides terminal blocks that allow flexible power connections and diode isolation for two separate power supply inputs.

The power rating required is dependent upon the sensor types, number of channels and configuration of the System 57. The following power budget calculation sheet allows for a quick and easy calculation of the worst case power requirement for the system. In many cases a lower power rating can be used, however, a more detailed power budget analysis should be performed to confirm the exact requirement.

The 8-Way AC to DC Power Supply Units can provide a 50W dc supply or a 100W dc supply depending upon whether one or two switch mode modules are incorporated in the power supply unit.

Similarly, the 16-Way AC to DC Power Supply Units can provide a 50W, 100W, 150W and 200W dc supplies depending upon whether one, two, three or four switch mode modules are incorporated in the power supply unit.

To calculate the power requirement:

- (1) Enter the number of devices of each type used in the system in column B.
- (2) Multiply by the unit power shown in column C.
- (3) Enter the result in column D.
- (4) Add up column D to calculate the total power required.

# CHAPTER 4 - INSTALLATION INSTRUCTIONS

Device or Sensor Type in Rack	Number Requirement (W)	Unit Power (W)	Total
A	B	x C	= D
<b>System 57 Devices:</b>			
Single Channel Control Card, Catalytic (includes bridge drive at 200mA)	_____	3.75	_____
Single Channel Control Card, 4-20mA (includes loop power)	_____	3.25	_____
Engineering Card	1	1.50	1.5
DC Input Card	1	0	0
Modbus Interface 232	_____	0.75	_____
Modbus Interface 422/485	_____	1.50	_____
Event Printing	_____	0.75	_____
Alarm Update	_____	0.25	_____
Update Panel	_____	0.20	_____
Field Wiring Card	_____	0	0
Relay Card - Double SPCO	_____	0.80	_____
Relay Card - Triple SPCO	_____	1.00	_____
Relay Card - Triple DPCO	_____	1.60	_____
Relay Card - High Integrity	_____	1.70	_____
Analogue Output Module (excludes loop power)	_____	0.50	_____
<b>Allowance for Transmitters and Sensors powered from System 57 PSU:</b>			
Searchline	_____	5.00	_____
Searchline Excel Receiver	_____	8.00	_____
Searchline Excel Transmitter (S/R)	_____	6.50	_____
Searchline Excel Transmitter (L/R)	_____	7.50	_____
Searchline Excel Cross Duct TX & RX	_____	13.0	_____
Searchpoint 500	_____	10.00	_____
Searchpoint Optima	_____	4.20	_____
Searchpoint Optima Plus	_____	4.5	_____
Series 2000 Toxic	_____	0	0
Series 2000 Combustible (incl UL)	_____	3.80	_____
Digi-Chem Toxic	_____	0.60	_____
Digi-Cat Combustible	_____	2.00	_____
Digi-Ana Toxic	_____	0.60	_____
Digi-Optima	_____	4.80	_____
Life Line	_____	0	_____
Others (refer to manufacturers data for column (C))	_____	x	_____
Apex Toxic*	_____	4.0	_____
Apex Combustible*	_____	5.5	_____
Opus/Lifeline II toxic*	_____	2.4	_____
Opus/Lifeline II combustible*	_____	2.9	_____
<b>TOTAL SYSTEM POWER REQUIREMENT</b>		<b>=</b>	<b>W</b>

\* All relays energised

---

# CHAPTER 4 - INSTALLATION INSTRUCTIONS

---

## 6. VENTILATION

The System 57 Control System provides the facility for a large number of channels in a very small space. In heavily populated racks, especially those with many catalytic input control cards or relays configured for normally energised operation, it is possible for the heat dissipation to cause a significant rise in temperature both within the rack and in an area close to the rack.

As such, careful consideration must be given to thermal planning. To achieve most from the convection cooling, always ensure that the air can flow freely through the rack and power supply. Do not obstruct the air vent holes in the top and bottom of the rack and if possible space the control cards evenly within the rack.

It is recommended that during commissioning the operating temperature of the rack is checked to ensure that the maximum operating temperature of 55°C is not exceeded. In some cases the addition of forced air ventilation may be required.

Maximum power supply configuration allowed without provision for additional ventilation is 100w for 8 way cabinet and 200w for 16 way cabinet.

---

# CHAPTER 4 - INSTALLATION INSTRUCTIONS

---

## 7. PRELIMINARIES

Ensure that each control card is compatible with the proposed sensor/transmitter to be connected to that control card.

Ensure that where an AC to DC Power Supply Unit is to be used, this is compatible with the local mains ac supply voltage and that the PSU power rating is adequate for its individual system load.

*Note: The model 05701-A-0405 and 05701-A-0406 AC to DC Power Supply Units operate, without the requirement of input voltage adjustments, from an 85V to 264V, 47Hz to 440Hz ac supply inputs.*

---

# CHAPTER 4 - INSTALLATION INSTRUCTIONS

---

## 8. CABINET INSTALLATION

Two cabinets are available, an 8-way to accommodate the 8-way **front access** rack and a 16-way to accommodate the 16-way **front access** rack.

The cabinet must be secured to a wall, or other suitable vertical surface, as follows:

- (1) Knock out the bottom gland-plate entries as appropriate for the system cabling and fit the glands before mounting the cabinet.
- (2) Attach the four mounting brackets provided to the cabinet.
- (3) Using the dimensions shown mark the position of the mounting holes on the mounting surface.
- (4) Drill and wall plug the mounting holes as necessary.

*Note: The mounting brackets will accept up to a 10mm diameter screw.*

- (5) Secure the cabinet in position using appropriate mounting screws.
- (6) Fit the System 57 Rack and AC to DC Power Supply Unit (if required) into the cabinet in the positions shown.
- (7) Pass cables through the gland adjacent to field terminal blocks, where possible keeping the sensor cable(s) separate from the other wiring.
- (8) Prepare and connect the cable ends to Field Interface and Relay Card terminals leaving sufficient cable length to allow for the rack to be withdrawn if future expansion is required. For terminal identification see Chapter 2.
- (9) Ensure that the cabinet is properly earthed by connecting a suitable earth cable to the earth stud located in the bottom panel of the cabinet.
- (10) Close and lock the cabinet.



### CAUTION

**Do not apply power to the System 57 until the commissioning procedure has been read and understood. See Section 5.**



# CHAPTER 4 - INSTALLATION INSTRUCTIONS

## Cabinet Dimensions:

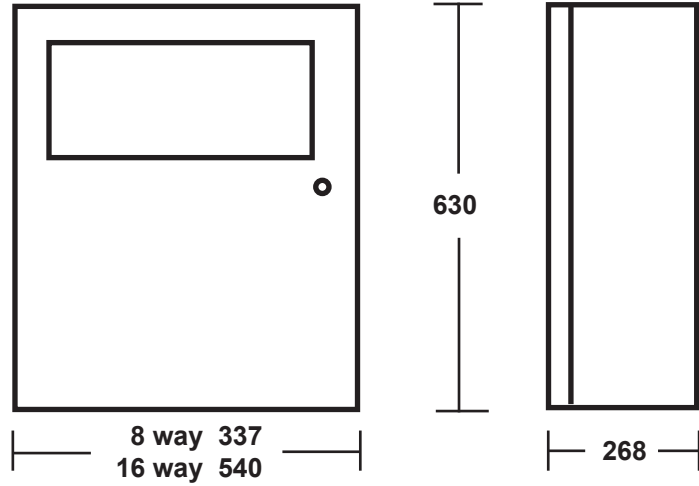

All dimension shown in mm.

## Wall Mounting Bracket Hole Locations

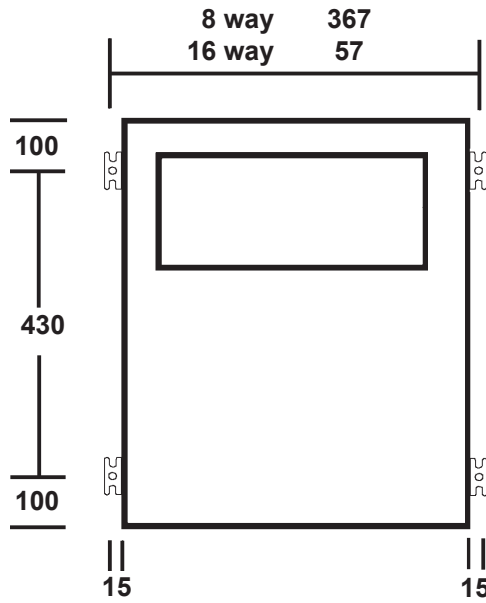

All dimension shown in mm.

## Cabinet Mounting Brackets

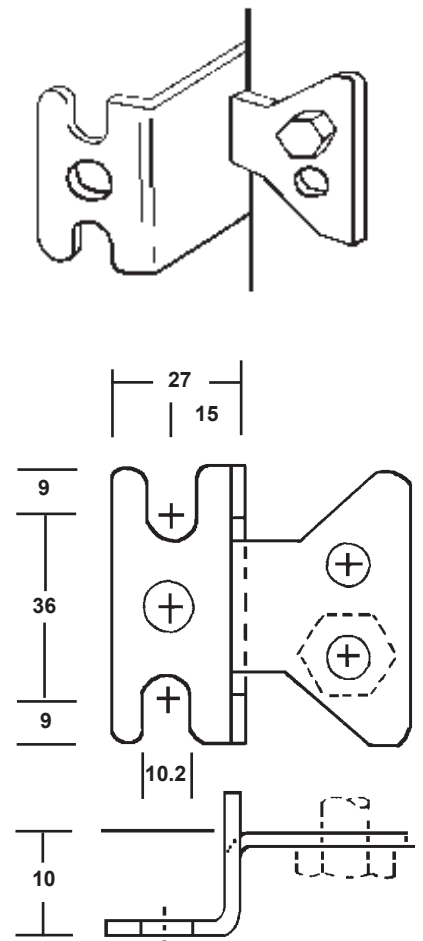

# CHAPTER 4 - INSTALLATION INSTRUCTIONS

## 16 Channel Cabinet Installation

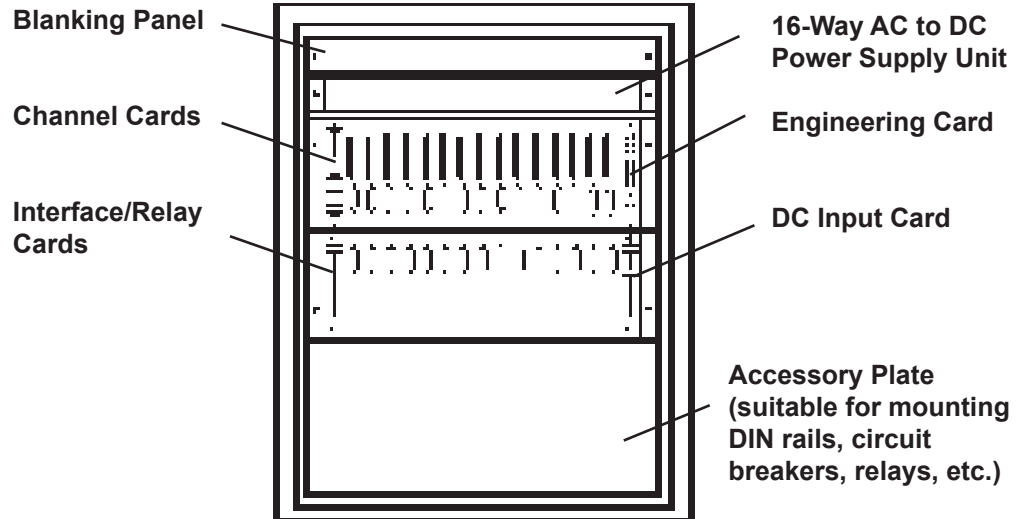

## Eight Channel Cabinet Installation

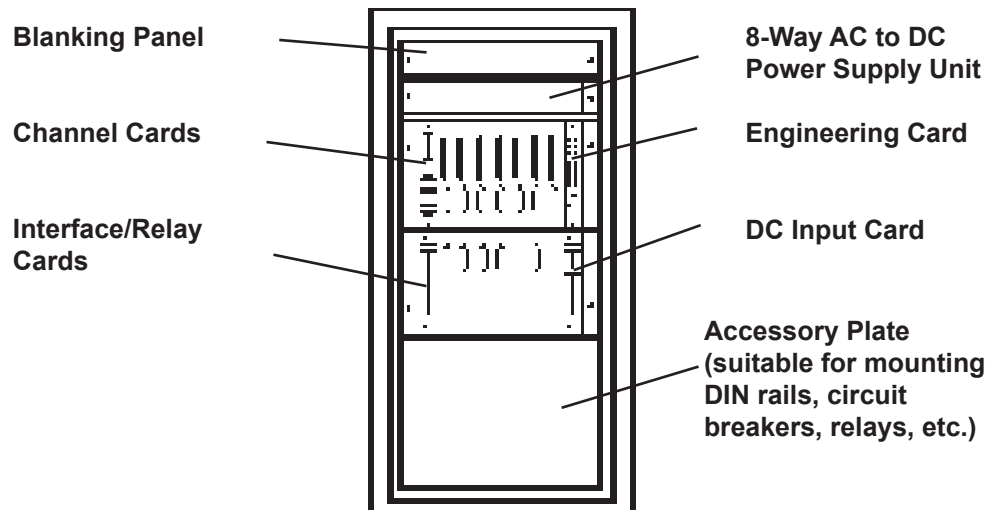

# CHAPTER 4 - INSTALLATION INSTRUCTIONS

## 9. PANEL INSTALLATION

All racks and the AC to DC Power Supply Units are suitable for panel installation and are installed as follows:

- (1) Cut out a suitable aperture to accommodate the System 57 rack and power supply unit (where required) using the dimensions shown:

### Rack Table of Sizes (mm)

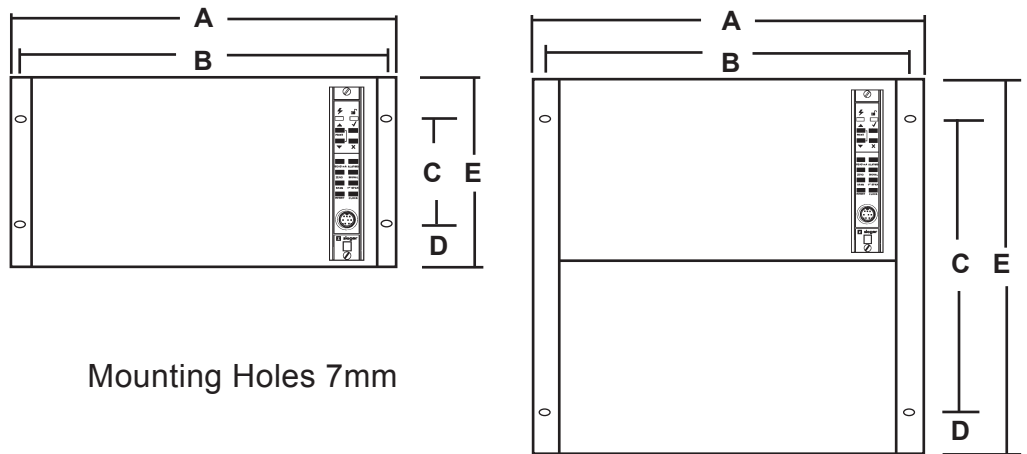

Mounting Holes 7mm

Rack Assembly	A	B	C	D	E	Depth
8 Way Rear Access	279.4	261.9	57.0	37.8	132.5	287.6
8 Way Front Access	279.4	261.9	190.5	37.8	266.0	217.6
16 Way Rear Access	482.6	465.1	57.0	37.8	132.5	287.6
16 Way Front Access	482.6	465.1	190.5	37.8	266.0	217.6
Panel Cutout Clearance						
8 Way 16 Way	Width:	247 450	Height as column E as column E			

# CHAPTER 4 - INSTALLATION INSTRUCTIONS

**AC to DC PSU Table of Sizes (mm)**

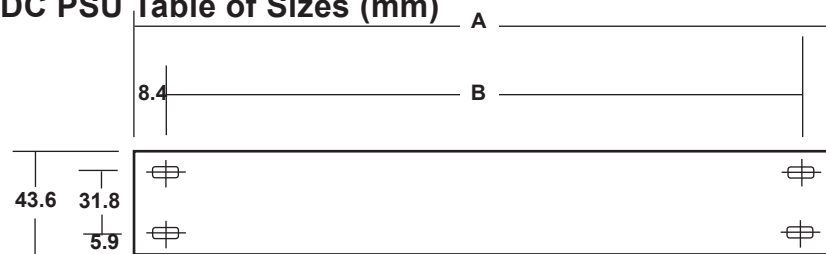

PSU Assembly	A	B	Clearance	
			Width	Height
8 Way	279.4	261.9	222	41
16 Way	482.6	465.1	443	41

- (2) Insert the rack into the aperture and secure using M6, or similar bolts, through the four mounting holes located upon the front flange plates.
- (3) Ensure adequate support at the rear of rear access racks.
- (4) Prepare and connect the cable ends to Field Interface and Relay Cards terminals. For terminal identification see Chapter 2. Where possible keep sensor cables separate from the other wiring.
- (5) Ensure that the rack is properly earthed by connecting a suitable earth cable to the earth stud located at the rear of the rack.



**CAUTION**

**Do not apply power to the System 57 until the commissioning procedure has been read and understood. See Chapter 5.**

---

# CHAPTER 4 - INSTALLATION INSTRUCTIONS

---

## 10. RACK INSTALLATION

The 16-way 3U high rear access and 6U high front access racks are suitable for mounting in standard 19" (483mm) wide Mounting Frames. These are fitted as follows:

- (1) Insert the rack into the 19" Mounting Frame and secure using M6 or similar bolts through the four mounting holes located on the front flange plates.
- (2) Ensure adequate support at the rear of rear access racks.
- (3) Prepare and connect the cable ends to Field Interface and Relay Card terminals. For terminal identification see Chapter 2. Where possible keep sensor cables separate from the other wiring.
- (4) Ensure that the rack is properly earthed by connecting a suitable earth cable to the earth stud located at the rear of the rack.



### CAUTION

**Do not apply power to the System 57 until the commissioning procedure has been read and understood. See Chapter 5.**

---

# CHAPTER 4 - INSTALLATION INSTRUCTIONS

---

## 11. SENSOR INSTALLATION

### 11.1 General

Always install the sensors in accordance with the Sensor Operating Instructions.

In general, sensors for lighter than air gasses should be located at a high level and sensors for heavier than air gasses should be located at a low level.

Do not install the sensors:

- a. Where the normal air flow may be impeded.
- b. In corners of rooms where static air pockets may exist.
- c. Near sources of heat such as convector heaters.

Do install the sensors:

- a. As close as possible to the potential source of gas to be detected in order to give the maximum possible warning.
- b. So that they are accessible for maintenance work.

### 11.2 Sensor Line Resistance

Sensors should be located such that the line resistance of cable does not exceed the maximum permitted. The table gives a quick guide to the maximum cable lengths permitted for specific sensors, when connected by stranded copper conductor cables of various sizes to a System 57 running at the minimum dc input voltage.

The figures in the table provide a useful reference guide to maximum cable lengths, however, in many circumstances longer cable runs can be used. eg. Where the dc input voltage is higher than the minimum. In these circumstances a more detailed analysis is required to determine maximum line resistance.

The following sections outline how to calculate the maximum line resistance for catalytic sensors, loop powered sensors and transmitters powered from the System 57. See Section 11.3 for a guide on cable selection.

# CHAPTER 4 - INSTALLATION INSTRUCTIONS

## Sensor Line Resistance

Device or Sensor Type	Maximum Cable Length (m)				
	Conductor Cross Sectional Area (mm <sup>2</sup> )				
	0.50	0.75	1.00	1.50	2.50
704/705	500	750	1000	1500	2500
780 (at 200mA bridge current)	500	750	1000	1500	2500
811	5600	8400	11200	16800	28000
910 (Single pair at 200mA)	480	720	960	1400	2400
910 (2 pair at 200mA)	230	340	460	690	1100
911	5600	8400	11200	16800	28000
Apex - Toxic	180	270	360	540	900
Apex - Combustible/Thick Film	130	195	260	390	650
Digi-Cat Combustible	400	600	800	1200	2000
Digi-Chem	1000	1500	2000	3000	5000
Digi-Ana	1000	1500	2000	3000	5000
Digi-Optima	180	270	360	540	900
Life Line	3200	4800	6400	9600	16000
Opus/LLII - Toxic	300	450	600	900	1500
Opus/LLII - Combustible	250	375	500	750	1250
Searchline (minimum dc supply 21V)	60	90	120	180	300
Searchpoint 500	32	48	64	96	160
Searchpoint OPTIMA (minimum dc supply 19V)	180	270	360	540	900
Series 2000 Combustible	450	670	900	1300	2200
Series 2000 Toxic	1600	2400	3200	4800	8000
Searchline Excel Receiver (minimum dc supply 21V)	90	135	179	271	449
Searchline Excel Transmitter (S/R) (minimum dc supply 21V)	141	211	282	425	704
Searchline Excel Transmitter (L/R) (minimum dc supply 21V)	94	141	188	283	998
Searchline Excel Cross Duct Transceiver assembly (minimum dc supply 21V)	55	82	109	165	274
Searchpoint Optima Plus	159	237	315	476	787
SensePoint Flam. LEL/ppm	500	750	1000	1500	2500
SensePoint Toxic	3200	4800	6400	9600	16000
SignalPoint Flamable	500	750	1000	1500	2500
Signal Point Toxic	2000	3000	4000	6000	10000

# CHAPTER 4 - INSTALLATION INSTRUCTIONS

## 11.3 Cable Resistance Guide

A guide to the resistance of various copper cable sizes is given below:

Solid Copper Conductor	
Cross Sectional Area (mm <sup>2</sup> )	Maximum resistance at 20°C (ohm/km)
0.50	38.0
0.75	25.3
1.00	19.0
1.50	12.6
2.50	7.6
Stranded Copper Conductor	
Cross Sectional Area (mm <sup>2</sup> )	Maximum resistance at 20°C (ohm/km)
0.50	36.8
0.75	24.5
1.00	18.4
1.50	12.3
2.50	7.4

## 11.4 Catalytic Sensors

The maximum line resistance of cabling for a catalytic sensor varies with the current and voltage requirements of the type of sensor installed. It is also subject to a maximum of 10V permitted across terminals S and NS at the Field Interface/Relay Card.

Maximum line loop resistance is calculated as follows:

$$R_L = \frac{10 - V_s}{I_s}$$

Where:  $R_L$  = Total Line Resistance (ohms)  
 $V_s$  = Sensor Voltage (V)  
 $I_s$  = Sensor Current (A)



---

# CHAPTER 4 - INSTALLATION INSTRUCTIONS

---

## 11.5 4-20mA Loop Powered Sensors:

The maximum line resistance of cabling for a 4 - 20mA loop powered sensor varies with the voltage drive requirements of the type of sensor installed. It is also subject to a 20V maximum loop drive voltage.

Maximum line loop resistance is calculated as follows:

$$R_L = \frac{20 - V_s}{0.025}$$

Where:  $R_L$  = Total Line Resistance (ohms)  
 $V_s$  = Minimum Sensor Operating Voltage (V)

## 11.6 4-20mA Transmitters

The maximum line resistance of cabling for a 4 - 20mA transmitter powered from the System 57 varies with the voltage and current requirements of the transmitter. It is also subject to the minimum supply voltage available from the System 57.

Maximum line loop resistance is calculated as follows:

$$R_L = \frac{V_r - V_s}{I_s}$$

Where:  $R_L$  = Total Line Resistance (ohms)  
 $V_r$  = Minimum DC Supply to System 57 (V)  
 $V_s$  = Sensor Voltage (V)  
 $I_s$  = Sensor Current (A)

Making the above calculation using a  $V_r$  of 18V will accommodate the worst case low dc supply situation.

The maximum resistance **per core** can be calculated from the above configurations as follows:

$$\text{Maximum Resistance of Core} = \frac{R_L}{2} \text{ ohms}$$

# CHAPTER 4 - INSTALLATION INSTRUCTIONS

## 12. CONTROL CARD SENSOR DRIVE MODULE CONFIGURATION

### 12.1 General

The sensor drive modules fitted to the Single Channel Control Cards have configuration links that effect the operation of the sensor. The following sections identify the links to allow the configuration to be inspected.

### 12.2 Single Channel Control Card, Catalytic Input Link Settings



#### CAUTION

**Incorrect setting of the Sensor Drive Module, Catalytic current range links may cause permanent damage to the sensor.**

The Sensor Drive Module, Catalytic has three solder link positions (LK1 to LK3) which allow setting of the bridge current range. The following ranges are available:

Range	Current	LK1	LK2	LK3
1	219mA to 283mA	S/C	S/C	S/C
2	66mA to 230mA	S/C	S/C	O/C
3	118mA to 182mA	O/C	S/C	O/C
4	70mA to 134mA	O/C	O/C	O/C

S/C - Short Circuit,

O/C - Open Circuit

The above information is only provided to allow the configuration of the Sensor Drive Module, Catalytic to be checked. The current range is factory set and should not be altered without reference to the SYSTEM 57 Technical Manual.

### 12.3 Single Channel Control Card, 4 - 20mA Input Link Settings



#### CAUTION

**Incorrect setting of the Sensor Drive Module, 4 - 20mA configuration links may cause permanent damage to the Control Card, Sensor Drive Module or Sensor.**

The Sensor Drive Module, 4 - 20mA is fitted with thirteen jumper links (LK1 to LK13) which allow numerous different sensor configurations to

# CHAPTER 4 - INSTALLATION INSTRUCTIONS

be accommodated. A link is closed by fitting the jumper provided so that the two pins of the link are connected. Unused links should have their jumper removed from the Sensor Drive Module altogether or carefully fitted over a **single** pin of an unused link as follows:

## Sensor Drive Module Open, Closed and Spare Link Arrangements

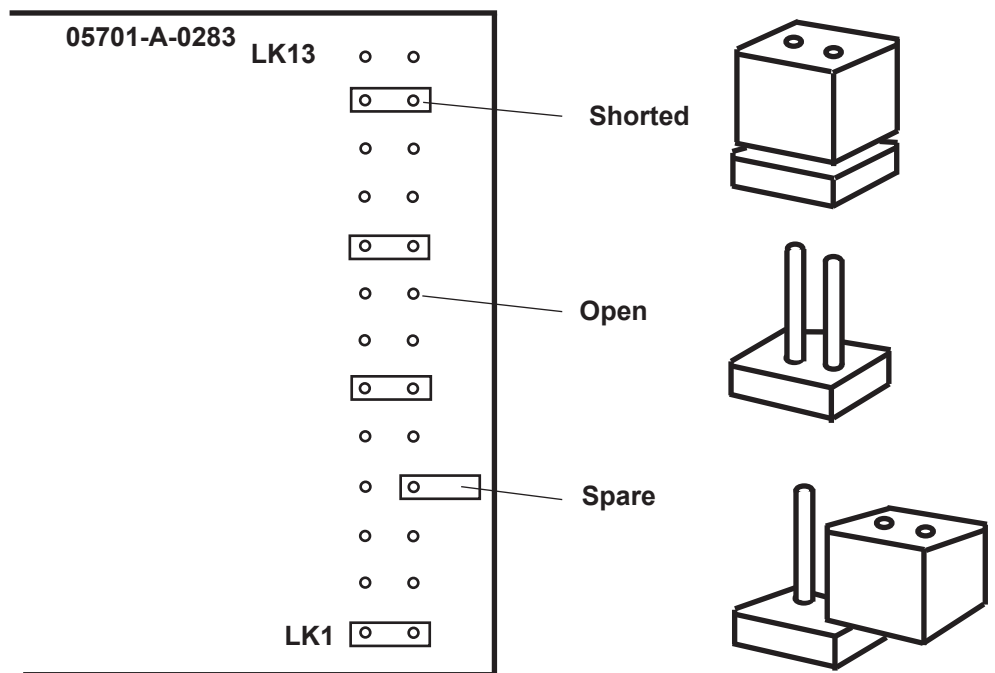

The closed link positions required for the most common sensor configurations are given in Section 13.3.

---

# CHAPTER 4 - INSTALLATION INSTRUCTIONS

---

## 13. SENSOR CONNECTIONS

### 13.1 General



#### WARNING

**Incorrect connection of the sensor wires may cause damage to both the sensor and System 57.**

#### CAUTION

**The sensors connections must always be made with the System 57 unit in an unpowered state. Isolate power supplies at their source before making connections.**

**Ensure that any external dc backup battery supply is also disabled.**

#### IMPORTANT

**In order to ensure the correct operation of the system and to meet European Standards for RFI and EMC, all sensor field cables must be screened. The cable screen of each sensor should be connected to the cabinet protective earth.**

Connect the cabling to sensors in accordance with the Sensor Operating Instructions and run the field cables back to the System 57 unit. The sensor cables should be routed away from sources of interference such as ac power cables, motors, machinery etc.

Use the information on the configuration sheet provided with the unit to decide which sensor to connect to each channel. The following sections describe the sensor connections for the Catalytic and 4 - 20mA input Single Channel Control Cards.

### 13.2 Catalytic Sensor Connections

Catalytic sensors require a three wire connection and the sensor documentation will indicate three connections S, 01 and NS, which are usually brown, white and blue respectively. In addition, the SensePoint combustible ppm version also has a screen connection.

At the System 57 end of the field cable, the three sensor wires should each be connected to the respective matching S, 01 or NS terminal on the Field Interface or Relay Card that is attached to the required Single Channel Display Card.

# CHAPTER 4 - INSTALLATION INSTRUCTIONS

The sensor cable screen or steel wire armour (or braid), as appropriate, should be connected to the system (protective) earth. This can be achieved where the cable enters the cabinet by using a metal cable gland, or by other suitable means, and avoiding any screen 'tails' within the cabinet.

Where the cable consists of a separate screen sheath and wire armour (or braid), the armour should be connected, at the cabinet entry, to the protective earth and the screen sheath should be connected to the GROUND terminal of the Field Interface/Relay Card or to a suitable instrument earth point.

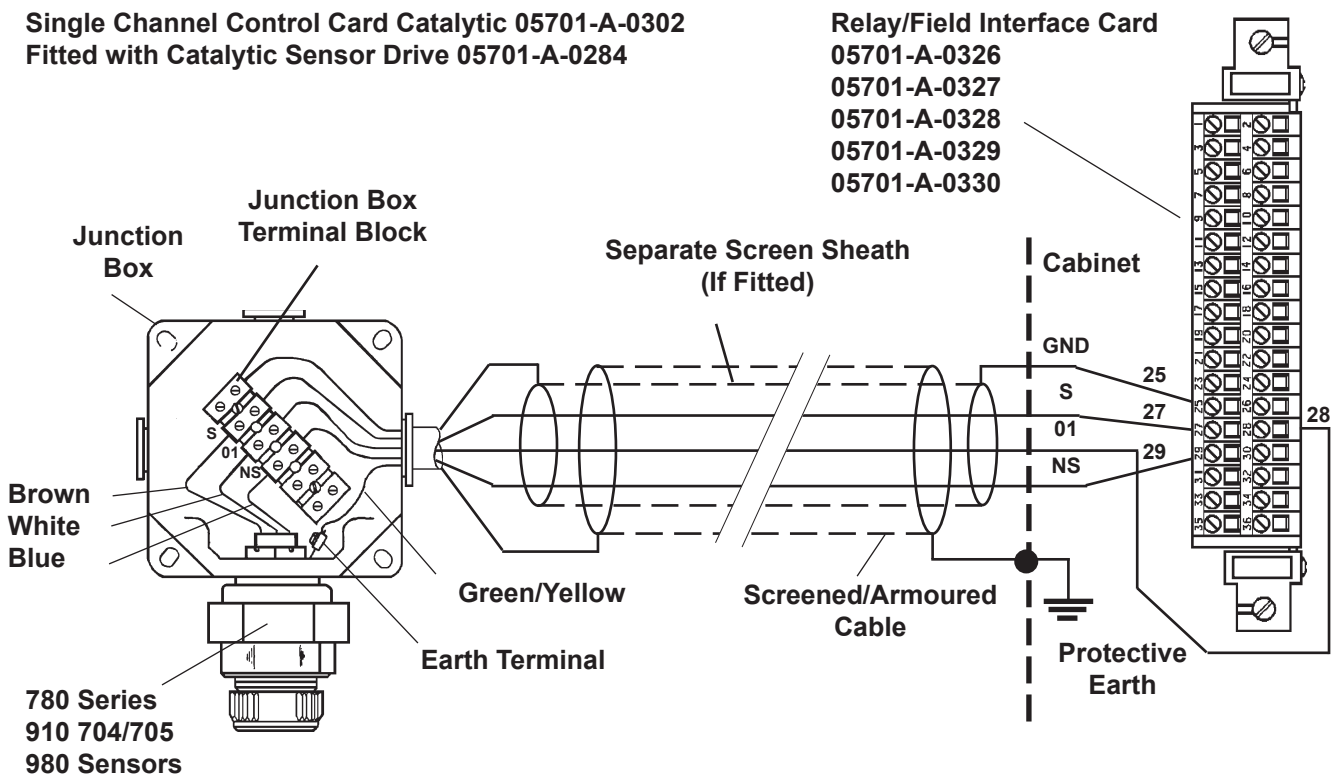

*Note: Where a sensor is earthed locally, either to the Earth Stud or through the sensor casing or mounting, to avoid earth loops the screen sheath of the cable should only be connected at one end, i.e., at the sensor or at the Interface/Relay Card.*

## Combustible Sensor, Junction Box and Terminal Block Connections

# CHAPTER 4 - INSTALLATION INSTRUCTIONS

## Single Channel Control Card Catalytic 05701-A-0302 Fitted with Catalytic Sensor Drive 05701-A-0284

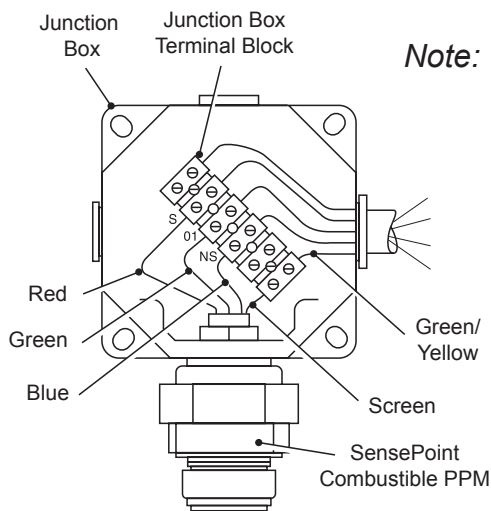
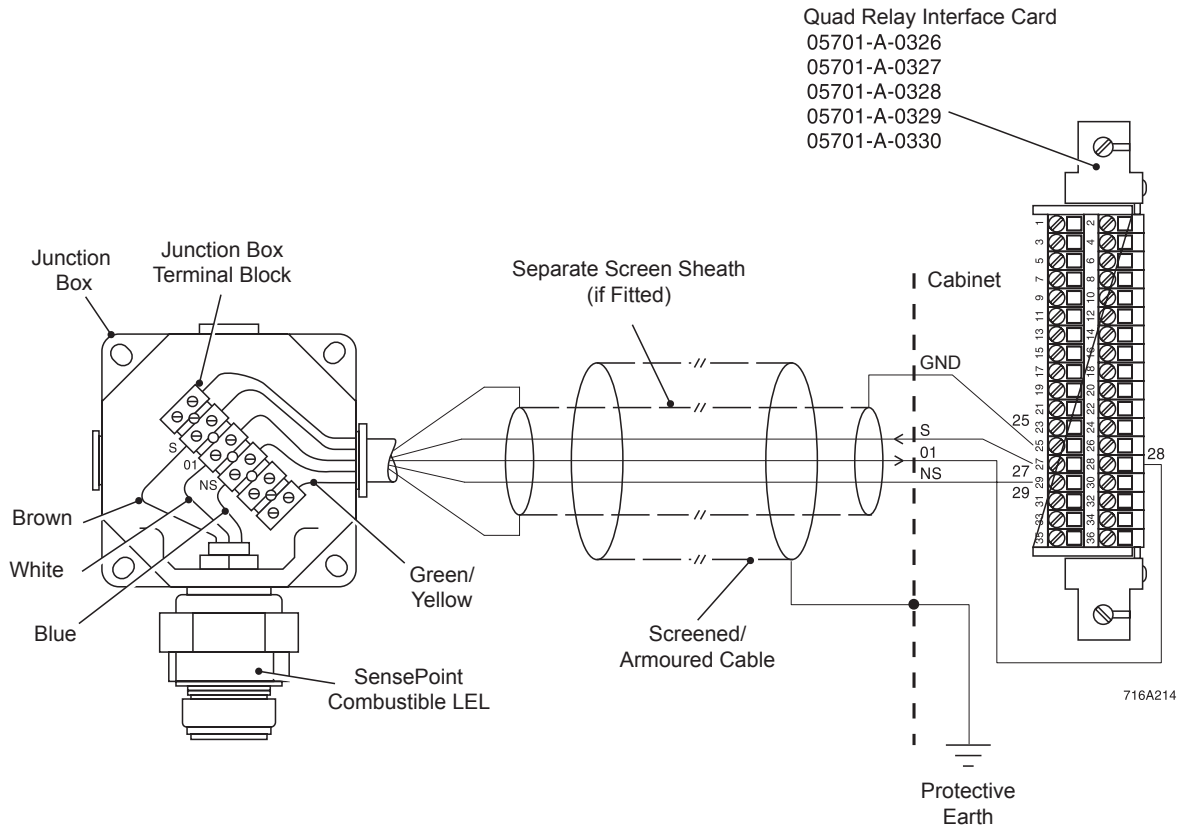

*Note: Where a sensor is earthed locally, either to the Earth Stud or through the sensor casing or mounting, to avoid earth loops the screen sheath of the cable should only be connected at one end, i.e., at the sensor or at the Interface/Relay Card.*

### SensePoint Combustible Sensor, Junction Box and Terminal Block Connections