



Guard I/O DeviceNet Safety Modules

Catalog Numbers 1732DS-IB8, 1732DS-IB8X0BV4,
1791DS-IB12, 1791DS-IB8X0B8, 1791DS-IB4X0W4,
1791DS-IB8X0BV4, 1791DS-IB16



Allen-Bradley

by ROCKWELL AUTOMATION

User Manual

Original Instructions

Important User Information

Read this document and the documents listed in the additional resources section about installation, configuration, and operation of this equipment before you install, configure, operate, or maintain this product. Users are required to familiarize themselves with installation and wiring instructions in addition to requirements of all applicable codes, laws, and standards.

Activities including installation, adjustments, putting into service, use, assembly, disassembly, and maintenance are required to be carried out by suitably trained personnel in accordance with applicable code of practice.

If this equipment is used in a manner not specified by the manufacturer, the protection provided by the equipment may be impaired.

In no event will Rockwell Automation, Inc. be responsible or liable for indirect or consequential damages resulting from the use or application of this equipment.

The examples and diagrams in this manual are included solely for illustrative purposes. Because of the many variables and requirements associated with any particular installation, Rockwell Automation, Inc. cannot assume responsibility or liability for actual use based on the examples and diagrams.

No patent liability is assumed by Rockwell Automation, Inc. with respect to use of information, circuits, equipment, or software described in this manual.

Reproduction of the contents of this manual, in whole or in part, without written permission of Rockwell Automation, Inc., is prohibited.

Throughout this manual, when necessary, we use notes to make you aware of safety considerations.



WARNING: Identifies information about practices or circumstances that can cause an explosion in a hazardous environment, which may lead to personal injury or death, property damage, or economic loss.



ATTENTION: Identifies information about practices or circumstances that can lead to personal injury or death, property damage, or economic loss. Attentions help you identify a hazard, avoid a hazard, and recognize the consequence.

IMPORTANT Identifies information that is critical for successful application and understanding of the product.

These labels may also be on or inside the equipment to provide specific precautions.



SHOCK HAZARD: Labels may be on or inside the equipment, for example, a drive or motor, to alert people that dangerous voltage may be present.



BURN HAZARD: Labels may be on or inside the equipment, for example, a drive or motor, to alert people that surfaces may reach dangerous temperatures.



ARC FLASH HAZARD: Labels may be on or inside the equipment, for example, a motor control center, to alert people to potential Arc Flash. Arc Flash will cause severe injury or death. Wear proper Personal Protective Equipment (PPE). Follow ALL Regulatory requirements for safe work practices and for Personal Protective Equipment (PPE).

The following icon may appear in the text of this document.



Identifies information that is useful and can help to make a process easier to do or easier to understand.

This manual contains new and updated information. Changes throughout this revision are marked by change bars, as shown to the right of this paragraph.

New and Updated Information

This table contains the changes made to this revision.

Topic	Page
Updated power supply requirements	14

Notes:

Preface	About the Specifications and Dimensions in This Manual	9
	Additional Resources	10
	Terminology	11
	Chapter 1	
About the Modules	Before You Begin	13
	Understand Suitability for Use	14
	Follow Precautions for Use	14
	Precautions to Mount, Wire, and Clean	17
	I/O Module Overview	17
	Programming Requirements	19
	Guard I/O Catalog Numbers	19
	About CIP Safety in DeviceNet Safety Architectures	19
	Identify Major Parts of the Modules	21
	Chapter 2	
Understand the Operation of Safety Functions	Safety I/O Modules	25
	Self-diagnostic Functions	26
	Configuration Lock	26
	I/O Status Data	26
	Safety Inputs	26
	Using a Test Output with a Safety Input	27
	Single Channel Mode	29
	Dual-channel Mode and Discrepancy Time	30
	Dual-channels, Equivalent	30
	Dual-channels, Complementary	31
	Safety Input Fault Recovery	33
	Input Delays	33
	Test Outputs Configured as Muting Outputs	34
	Safety Outputs	36
	Safety Output with Test Pulse	36
	Dual-channel Setting	37
	Safety Output Fault Recovery	37
	Controlling Devices	38
	Safety Precautions	38
	Legislation and Standards	39
	Europe	39
	North America	40
	Japan	40
	EC Directives	41
	EMC Directive	41
	Compliance with EC Directives	41

	Chapter 3	
Install and Connect Your Modules	Considerations for Module Installation	43
	Install the Module	44
	Connect I/O Power and I/O Cables	45
	Connect Communication Connectors	46
	Set the Node Address	46
	Chapter 4	
Wiring Examples	Input Examples	47
	Emergency Stop Switch Dual-channel Inputs with Manual Reset .	48
	Two-hand Monitor	49
	Mode Select Switch	50
	Light Curtain	51
	Reset Switch	52
	Source Output Examples	53
	Redundant Safety Contactors	53
	Single Channel	54
	Bipolar Output Examples	55
	Dual-load Bipolar Outputs	55
	Single Channel	56
	Relay Output Examples	57
	Relay Outputs with Dual-channel Mode and External Device Monitoring Input	57
	Interlock String	58
	Test Output Examples	59
	Standard Inputs and Outputs	59
Muting Lamp Output	60	
	Chapter 5	
Configure Modules with the Logix Designer Application	Use the Help Button	61
	Add Modules to the I/O Configuration Tree	62
	Set Up the Module Definition	64
	Values and States of Tags	70
	Configure the Safety Tab	71
	Configuration Ownership - Reset Ownership	73
	Configuration Signature	73
	Configure the Input Configuration Tab	74
	Configure the Test Output Tab	76
	Configure the Output Configuration Tab	77
Save and Download Module Configuration	79	

	Chapter 6	
Configure Modules in RSNetWorx for DeviceNet Software	Before You Begin	81
	Add Modules to the I/O Configuration.....	82
	Safety Network Number (SNN).....	83
	Configuration Signature	85
	Configure the I/O Module.....	86
	Configure the Input Channel	86
	Configure the Test Output.....	89
	Configure the Output Channel.....	90
	Configure Input and Output Error Latch Times.....	90
	Save and Download the Module Configuration.....	92
	Set Up the 1791DS I/O Module Definition.....	93
	Set the Connection Type	99
	Set the Connection Configuration.....	100
	Set the Communication Parameters.....	101
	Configuration Ownership—Reset Ownership	103
	Set the Safety Network Number (SNN).....	105
	Set Your Password.....	107
I/O Data Tab.....	108	
Troubleshooting	109	
	Chapter 7	
Considerations When Replacing Guard I/O Modules	Considerations When Replacing Guard I/O Modules.....	115
	Why You Need to Manually Set the SNN	116
	GuardLogix Controllers versus SmartGuard Controllers.....	117
	Replacing an I/O Module When Using a SmartGuard Controller...	117
	Replacing an I/O Module When Using a GuardLogix Controller ...	121
	I/O Replacement with ‘Configure Only When No Safety Signature Exists’ Enabled	121
I/O Replacement with ‘Configure Always’ Enabled	126	
	Chapter 8	
Interpret Status Indicators	Module Indicators	129
	Module Status and Network Status Indicators Combination.....	130
	1791DS-IB12, 1791DS-IB8XOB8, and 1791DS-IB4XOW4 Status Indicators	131
	1732DS-IB8XOBV4, 1732DS-IB8, 1791DS-IB8XOBV4, and 1791DS-IB16 Status Indicators	133

Get Point Status from Modules by Using Explicit Messaging	Appendix A	
	Considerations for Obtaining Point Status	137
	1791DS-IB8XOB8 Module Definition Configuration	138
	1791DS-IB4XOW4 Module Definition Configuration	142
	1791DS-IB12 Module Definition Configuration	145
	I/O Assembly and Reference Data	148
	1791DS-IB12, 1791DS-IB8XOB8, 1791DS-IB4XOW4 Data ..	148
	1732DS-IB8, 1732DS-IB8XOBV4, 1791DS-IB8XOBV4, and	
	1791DS-IB16 Data	152
	Explicit Messages	155
	Basic Format of Explicit Messages.....	157
	Explicit Messages	158
Safety Data	Appendix B	
	161
Configuration Reference Information	Appendix C	
	Understanding Parameter Groups	165
	Allocate Remote I/O	167
	I/O Data Supported by Each Module	167
Index	175

Read and understand this manual before using the described products. Consult your Rockwell Automation representative if you have any questions or comments. This manual describes how to use the Guard I/O modules.

This manual is intended for users of ArmorBlock and CompactBlock Guard I/O modules. Hereafter, in this manual we refer to the modules as Guard I/O modules.

About the Specifications and Dimensions in This Manual

Product specifications and accessories can change at any time based on improvements and other reasons. Consult with your Rockwell Automation representative to confirm actual specifications of purchased product. Dimensions and weights are nominal and are not for use for manufacturing purposes, even when tolerances are shown.

Additional Resources

Refer to the following as needed for additional help when setting up and using your modules. For specifications refer to the relevant installation instructions. You can view or download publications at <http://www.rockwellautomation.com/literature>. To order paper copies of technical documentation, contact your local Allen-Bradley distributor or Rockwell Automation sales representative.

Resource	Description
ArmorBlock Guard I/O DeviceNet Module Installation Instructions, publication 1732DS-IN001	Provides detailed specifications and information related to installation of Guard I/O modules.
CompactBlock Guard I/O DeviceNet Module Installation Instructions, publication 1791DS-IN002	
DeviceNet Modules in Logix5000 Control Systems User Manual, publication DNET-UM004	Provides information on how to connect the controller to the network.
DeviceNet Safety I/O Modules Series 1791DS Installation Instructions, publication 1791DS-IN001	Provides detailed specifications and information related to installation of these Guard I/O modules: 1791DS-IB12, 1791DS-IB8X0B8, and 1791DS-IB4X0W4.
DeviceNet Safety Scanner for GuardPLC Controllers User Manual, publication 1753-UM002	Provides information on installing, operating, and maintaining the scanner.
GuardLogix 5570 Controller Systems Safety Reference Manual, publication 1756-RM099	Provides information on safety application requirements for GuardLogix 5570 controllers in Studio 5000 Logix Designer projects.
GuardLogix 5570 Controllers User Manual, publication 1756-UM022	Provides information on how to install, configure, program, and use GuardLogix 5570 controllers in Studio 5000™ Logix Designer projects.
GuardLogix Controller Systems Safety Reference Manual, publication 1756-RM093	Provides information on safety application requirements for GuardLogix 5560 and 5570 controllers in RSLogix 5000 projects.
GuardLogix Controllers User Manual, publication 1756-UM020	Provides information on how to install, configure, program, and use GuardLogix 5560 and 5570 controllers in RSLogix 5000 projects.
GuardLogix Safety Application Instructions Safety Reference Manual, publication 1756-RM095	Provides reference information describing the GuardLogix Safety Application Instruction Set.
GuardPLC Controller Systems User Manual, publication 1753-UM001	Describes in brief the safety concept of the GuardPLC family of controllers.
GuardPLC Safety Reference Manual, publication 1753-RM002	Explains how the GuardPLC control system can be used in safety applications.
ODVA Media Planning and Installation Guide, publication 00148-BR001	Describes the required media components and how to plan for and install these required components.
SmartGuard 600 Controllers Installation Instructions, publication 1752-IN001	Provides information related to installation of SmartGuard 600 controllers.
SmartGuard 600 Controllers Safety Reference Manual, publication 1752-RM001	Describes SmartGuard 600-specific safety requirements and controller features.
SmartGuard 600 Controllers User Manual, publication 1752-UM001	Describes how to configure, operate, and troubleshoot the controller.
ODVA Planning and Installation Manual, publication 00027 , available from the EtherNet/IP Library at ODVA.org	Describes the required media components and how to plan for and install these required components.

Terminology

Refer to the table for the meaning of common terms.

Term	Meaning
Bus off	Indicates a status of very high error-count occurrence on a communication cable. A bus off error is detected when the internal error counter counts more errors than the predetermined threshold value. (The error counter returns to zero when the master is started or restarted.)
Connection	Logical communication channel for communication between nodes. Connections are maintained and controlled between masters and slaves.
CRTL	Connection reaction time limit.
DeviceNet safety	An implementation of a safety protocol on a standard DeviceNet network.
EDS	Acronym for electronic data sheet, a template that RSNetWorx for DeviceNet software uses to display the configuration parameters, I/O data profile, and connection-type support for a given DeviceNet safety module. These are text files used by RSNetWorx for DeviceNet software to identify products and commission them on a network.
L-	Output +24V DC common.
M	Sinking output common channel, output switches to the common voltage.
MTBF	Acronym for mean time between failure, the average time between failure occurrences.
ODVA	Acronym for Open DeviceNet Vendor Association, a nonprofit association of vendors established for the promotion of DeviceNet networks.
P	Sourcing output channel, output switches to the plus voltage.
PFD	Acronym for probability of failure on demand, the average probability of a system to fail to perform its design function on demand.
PFH	Acronym for probability of failure per hour, the probability of a system to have a dangerous failure occur per hour.
Proof test	Periodic test performed to detect failures in a safety-related system so that, if necessary, the system can be restored to an as-new condition or as close as practical to this condition.
S+	Output +24V DC.
SNN	Acronym for safety network number, which uniquely identifies a network across all networks in the safety system. You are responsible for assigning a unique number for each safety network or safety sub-net within a system.
Standard	Devices or portions of devices that do not participate in the safety function.

Notes:

About the Modules

Topic	Page
Understand Suitability for Use	14
Follow Precautions for Use	14
Precautions to Mount, Wire, and Clean	17
I/O Module Overview	17
Guard I/O Catalog Numbers	19
About CIP Safety in DeviceNet Safety Architectures	19
Identify Major Parts of the Modules	21

This chapter includes important information and precautions for using Guard I/O modules that implement the DeviceNet safety protocol and how to use the modules within a safety system.

Before You Begin

Always observe the following guidelines when using a module, noting that in this manual we use safety administrator to mean a person qualified, authorized, and responsible to secure safety in the design, installation, operation, maintenance, and disposal of the machine.

- Thoroughly read and understand this manual before installing and operating the module.
- Keep this manual in a safe place where personnel can refer to it when necessary.
- Use the module properly according to the installation environment, performance, and functions of the machine.
- Verify that a safety administrator conducts a risk assessment on the machine and determines module suitability before installation.
- Verify for CE LVD compliance, the external power supply that provides power to the modules is safety extra-low voltage (SELV) rated. Some Rockwell Automation Bulletin 1606 power supplies are SELV-compliant. Verify this in the Bulletin 1606 Installation Instructions.

Verify that the Guard I/O firmware version is correct prior to commissioning the safety system, noting that firmware information related to safety controllers is available at <http://www.rockwellautomation.com/products/certification/safety>.

Understand Suitability for Use

Rockwell Automation is not responsible for conformity with any standards, codes, or regulations that apply to the combination of the products in your application or use of the product.

Take all necessary steps to determine the suitability of the product for the systems, machine, and equipment with which it is used.

Know and observe all prohibitions of use applicable to this product.

Never use the products for an application involving serious risk to life or property without making sure that the system as a whole was designed to address the risks and that the Rockwell Automation product is properly rated and installed for the intended use within the overall equipment or system.

Follow Precautions for Use



ATTENTION: Safety state of the inputs and outputs is defined as the off state.

Safety state of the module and its data is defined as the off state.

Use the Guard I/O module only in applications where the off state is the safety state.

Serious injury may occur due to breakdown of safety outputs. Do not connect loads beyond the rated value to the safety outputs.

Serious injury may occur due to loss of required safety functions. Wire the module properly so that supply voltages or voltages for loads do **not** touch the safety outputs accidentally or inadvertently.



ATTENTION: Use DC supply satisfying the following requirements to prevent electric shock:

A DC power supply with double or reinforced insulation, for example, according to IEC/EN 60950 or EN 50178 or a transformer according to IEC/EN 61558



ATTENTION: Electrical Safety Considerations

(1791DS-IB12, 1791DS-IB8XOB8, 1791DS-IB4XOW4 only). Power to this equipment and all connected I/O must be supplied from a source compliant with the following: Class 2 approved to UL1310.



ATTENTION: Follow these precautions for safe use.

- Wire conductors correctly and verify operation of the module before placing the system into operation. Incorrect wiring may lead to loss of safety function.
 - Do not apply DC voltages exceeding the rated voltages to the module.
 - Apply properly specified voltages to the module inputs. Applying inappropriate voltages may cause the module to fail to perform its specified function, which could lead to loss of safety functions or damage to the module.
 - Never use test outputs as safety outputs. Test outputs are not safety outputs.
 - Note that after installation of the module, a safety administrator must confirm the installation and conduct trial operation and maintenance.
 - Do not disassemble, repair, or modify the module. This may result in loss of safety functions.
 - Use only appropriate components or devices complying with relevant safety standards corresponding to the required safety category and safety integrity level.
 - Conformity to requirements of the safety category and safety integrity level must be determined for the entire system.
 - We recommend you consult a certification body regarding assessment of conformity to the required safety integrity level or safety category.
 - Note that you must confirm compliance with the applicable standards for the entire system.
 - Disconnect the module from the power supply before wiring. Devices connected to the module may operate unexpectedly if wiring is performed while power is supplied.
-

For 1791DS-IB4XOW4 modules, follow these instructions on isolating transformer use. Refer to the isolating transformer figure.

- Use an isolating transformer to isolate between over-voltage category III and II, such as TR1, to conform to IEC 60742.
- Be sure the insulation between first input and secondary output satisfies at least basic insulation of over-voltage category III.
- Be sure one side of a secondary output of the isolating transformer is grounded to prevent electric shock to personnel due to a short to ground or short to the frame of the isolating transformer.
- Insert fuses, in case of a short to the frame, to protect the isolating transformer and prevent electric shock to personnel, per transformer specifications, at points such as F1, F2, and F3.

Figure 1 - Use of Isolating Transformer

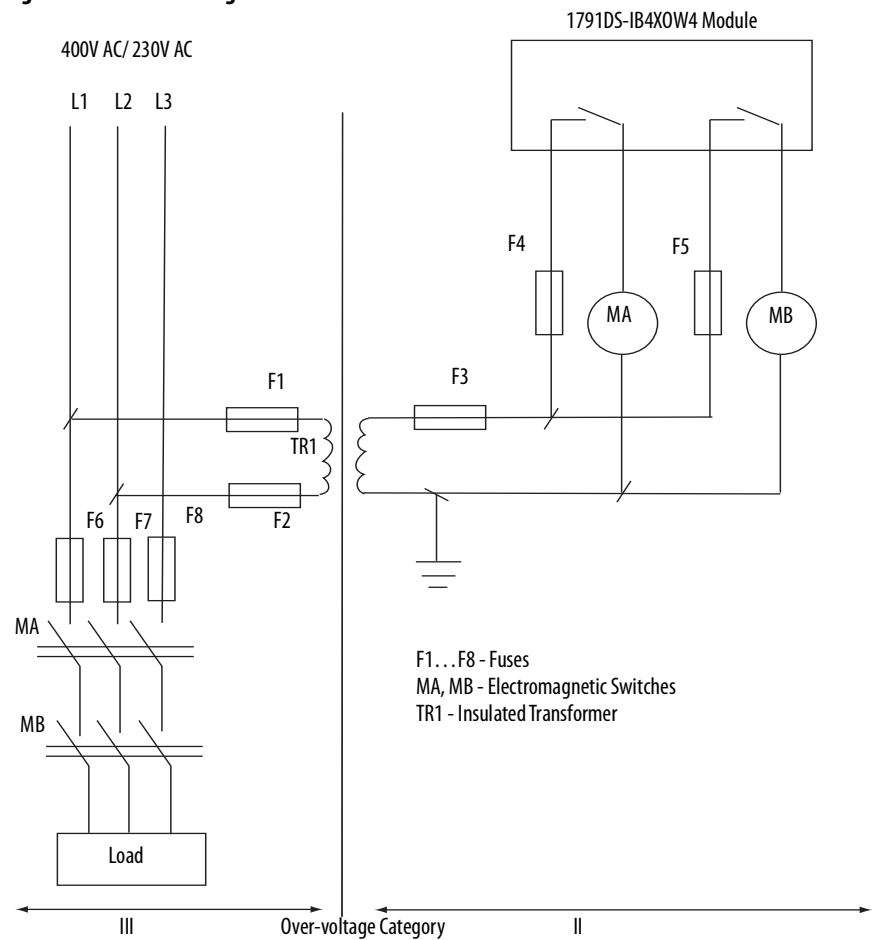

Precautions to Mount, Wire, and Clean

Observe these precautions to prevent operation failure, malfunctions, or undesirable effects on product performance.

Follow these precautions when mounting modules:

- Use DIN rail that is 35 mm (1.38 in.) wide to mount the module into the control panel.
- Mount modules to DIN rail securely.
- Leave at least 50 mm (1.96 in.) above and below the module to allow adequate ventilation and room for wiring for 1791DS-IB12, 1791DS-IB8XOB8, and 1791DS-IB4XOW4 modules.
- Leave at least 15 mm (0.6 in.) around the module to allow adequate ventilation and room for wiring for 1732DS-IB8, 1732DS-IB8XOBV4, 1791DS-IB8XOBV4, and 1791DS-IB16 modules.

Follow these precautions when wiring modules:

- Do not place communication lines and I/O lines in the same wiring duct or track as high voltage lines.
- Wire correctly after confirming the signal names of all terminals.
- Do not remove the shield from a module before wiring, but always remove the shield after completing wiring to be sure of proper heat dispersion for 1791DS-IB12, 1791DS-IB8XOB8, and 1791DS-IB4XOW4 modules.
- Follow torquing specifications as indicated in the installation instructions.

When cleaning modules, do not use the following:

- Thinner
- Benzene
- Acetone

I/O Module Overview

The Guard I/O modules implement the CIP-safety protocol extensions over DeviceNet networks and provide various features for a safety system.

Use the modules to construct a safety-control network system that meets the requirements up to Safety Integrity Level 3 (SIL 3) as defined in IEC 61508, Functional Safety of Electrical, Electronic, and Programmable Electronic Safety-related Systems, and the requirements for Safety Category 4 of the EN 954-1 standard, Safety of machinery - Safety related parts of control systems. All 1791DS modules can be mounted vertically or horizontally.

Remote I/O communication for safety I/O data are performed through safety connections supporting CIP safety over a DeviceNet network. Data processing is performed in the safety controller.

The status and fault diagnostics of Guard I/O modules are monitored by a safety controller through a safety connection using a new or existing DeviceNet network.

The following is a list of features common to Guard I/O modules:

- CIP-safety and DeviceNet protocol conformance
- Safety inputs
 - Safety devices, such as emergency stop push buttons, gate switches, and safety light curtains, can be connected.
 - Dual-channel mode evaluates consistency between two input signals (channels), which allows use of the module for Safety Category 3 and 4.
 - The time of a logical discrepancy between two channels can be monitored using a discrepancy time setting.
 - An external wiring short-circuit check is possible when inputs are wired in combination with test outputs. The module must be wired in combination with test outputs when this function is used.
 - Independently adjustable on and off delay is available per channel.
- Test outputs
 - Separate test outputs are provided for short circuit detection of a safety input (or inputs).
 - Power (24V) can be supplied to devices, such as safety sensors.
 - Test outputs can be configured as standard outputs.
 - All Guard I/O modules have numerous test outputs, of which some can be used for broken wire detection of a muting lamp.
- Safety outputs
 - Solid state outputs
 - Dual-channel mode evaluates consistency between two output signals (channels).
 - Safety outputs can be pulse tested to detect field wiring shorts to 24V DC.
 - All 1791DS-IB8XOBV4 modules' safety outputs use pulse testing to detect a short to 24V DC on the safety source output (P), and a short to 0V DC on the safety sink output (M).
 - Relay Outputs
 - Dual-channel mode evaluates consistency between two output signals (channels).
 - Up to 2 A is provided per output point.
 - Safety relays can be replaced.
- I/O status data - In addition to I/O data, the module includes status data for monitoring I/O circuits.
- Security - The configuration information of the module can be protected by a password.
- Removable I/O connectors - I/O connectors support mechanical keying.

Programming Requirements

Use the minimum software versions listed here.

Cat. No.	Studio 5000 Environment Version ⁽¹⁾	RSLogix 5000 Software Version ⁽¹⁾ (EtherNet/IP Network)	RSNetWorx for DeviceNet Software Version ⁽¹⁾ (DeviceNet Network)	RSLinux Software Version ⁽¹⁾
1732DS-IB8, 1732DS-IB8XOBV4, 1791DS-IB12, 1791DS-IB8XOB8, 1791DS-IB4XOW4, 1791DS-IB8XOBV4, 1791DS-IB16	21	17	8	2.51

(1) This version or later.

Guard I/O Catalog Numbers

See the table for a listing of the types of Guard I/O modules.

Cat. No.	Description	Enclosure Type Rating	Safety Inputs	Test Outputs	Safety Outputs	
					Solid State	Relays
1732DS-IB8	Safety input module	Meets IP64/65/67	8	8	-	-
1732DS-IB8XOBV4	Safety I/O module with solid state outputs		8	8	4 bipolar pairs	-
1791DS-IB12	Safety input module	Meets IP20	12	4	-	-
1791DS-IB8XOB8	Safety I/O module with solid state outputs		8	4	8	-
1791DS-IB4XOW4	Safety I/O module with relay outputs		4	4	-	4
1791DS-IB8XOBV4	Safety I/O module with solid state outputs		8	8	4 bipolar pairs	-
1791DS-IB16	Safety input module		16	16	-	-

About CIP Safety in DeviceNet Safety Architectures

Use Guard I/O modules in DeviceNet safety architectures as shown below.

The Guard I/O family is a set of I/O modules that when connected to a DeviceNet safety network are suitable for applications up to SIL3, as defined in the IEC 61508 standard, and Safety Category 4, as defined in the EN 954-1 standard.

Figure 2 - Guard I/O Modules in DeviceNet Safety Architectures

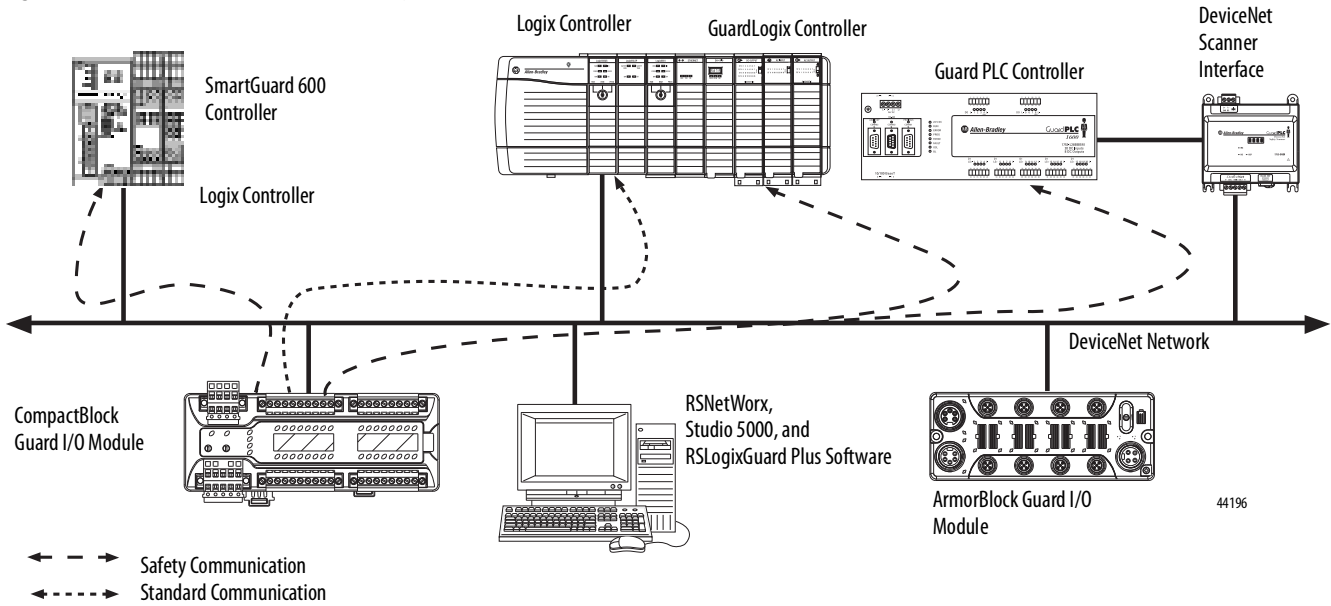

Safety controllers control the safety outputs. Safety or standard PLC controllers can control the standard outputs.

Identify Major Parts of the Modules

See the figures for module identification. For pin-out information, refer to the relevant installation instructions.

Figure 3 - 1791DS-IB4XOW4 Module Identification

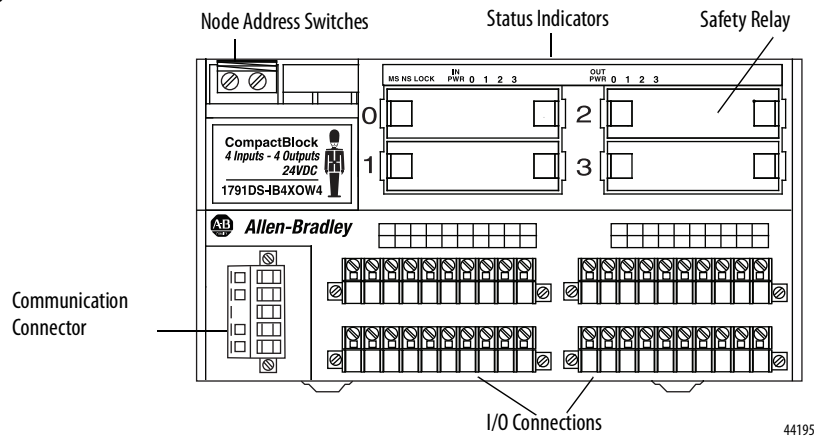

Figure 4 - 1791DS-IB8XOB8 Module Identification

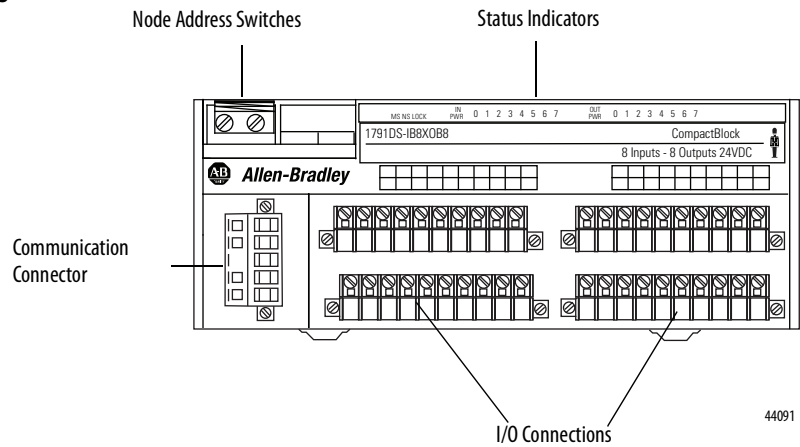

Figure 5 - 1791DS-IB12 Module Identification

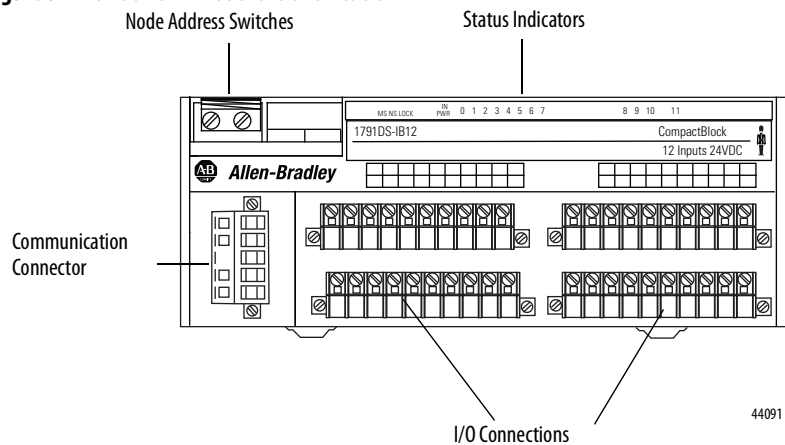

Figure 6 - 1791DS-IB8XOBV4 Module Identification

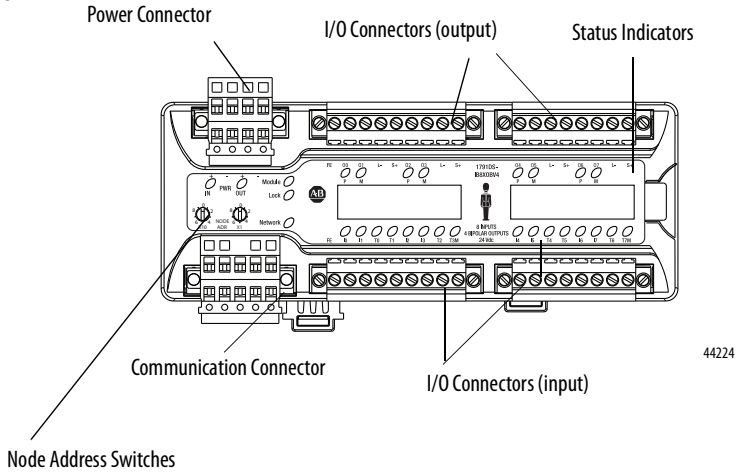

Figure 7 - 1732DS-IB8 Module Identification

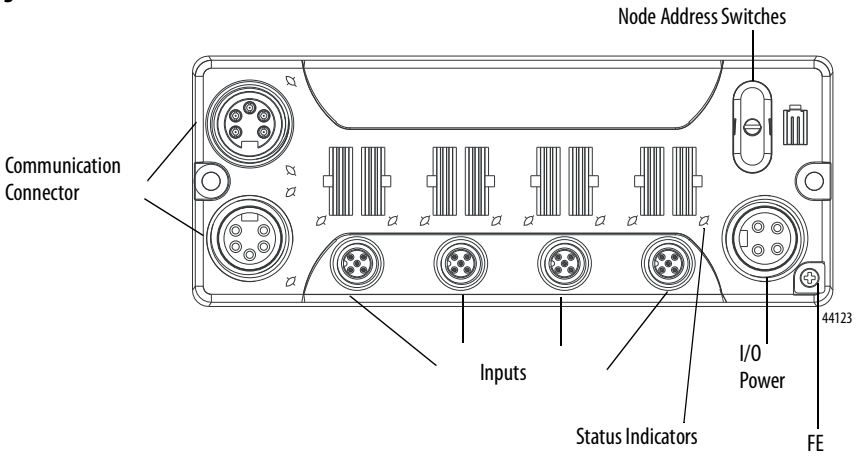

Figure 8 - 1732DS-IB8XOBV4 Module Identification

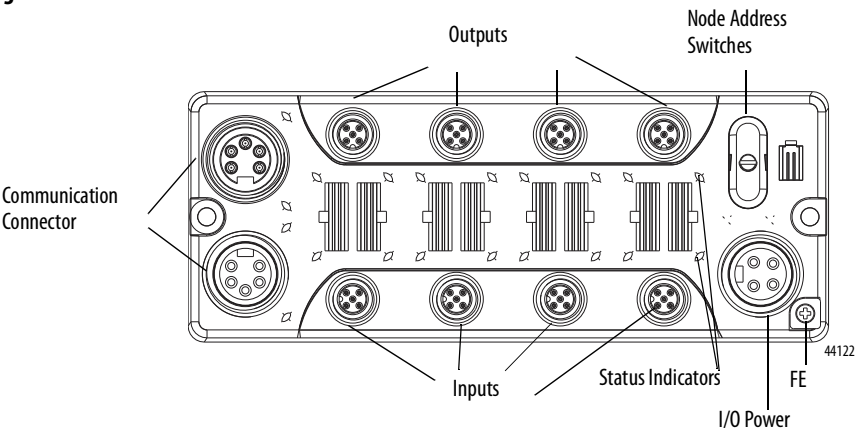
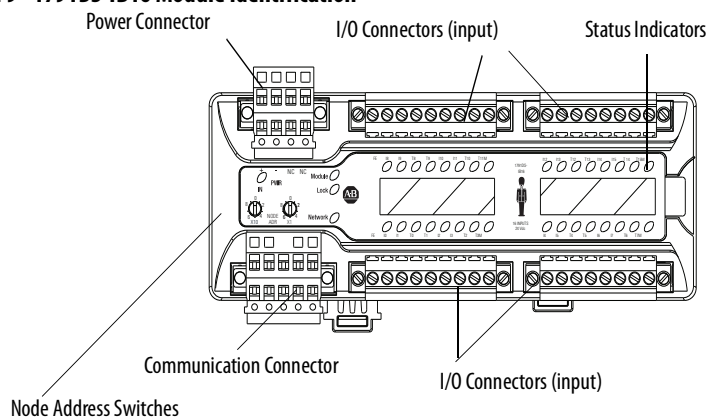

Figure 9 - 1791DS-IB16 Module Identification

Notes:

Understand the Operation of Safety Functions

Topic	Page
Safety I/O Modules	25
Self-diagnostic Functions	26
Configuration Lock	26
I/O Status Data	26
Safety Inputs	26
Test Outputs Configured as Muting Outputs	34
Safety Outputs	36
Controlling Devices	38
Safety Precautions	38
Legislation and Standards	39
EC Directives	41

Read this chapter for information related to the safety functions of the modules. Also included is a brief overview on international standards and directives that you should be familiar with.

Safety I/O Modules

The following status is the safety state of the Guard I/O modules:

- Safety outputs: off
- Safety input data to network: off

Figure 10 - Safety Status

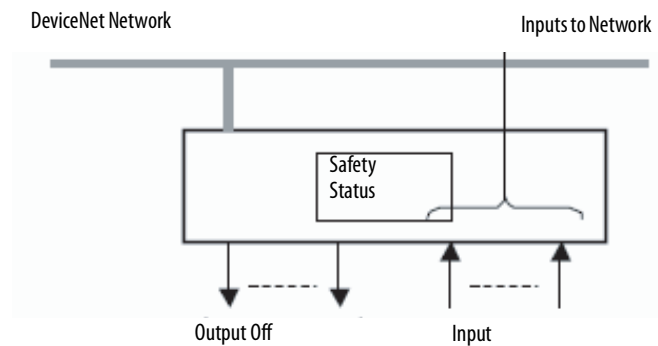

44076

The module is designed for use in applications where the safety state is the off state.

Self-diagnostic Functions

Self-diagnostics are performed when the power is turned on and periodically during operation. If a fatal internal module error occurs, the red module status (MS) indicator is illuminated, and the safety outputs and input data and status to the network turn off.

Configuration Lock

After configuration data has been downloaded and verified, the configuration data within the module can be protected by using RSNetWorx for DeviceNet software.

For GuardLogix systems, this status indicator is not used. Reference information about safety signatures in the GuardLogix Controller Systems Safety Reference Manual, publication [1756-RM093](#) or the GuardLogix 5570 Controller System Safety Reference Manual, publication [1756-RM099](#).

I/O Status Data

In addition to I/O data, the module provides status data for monitoring the I/O circuits. The status data includes the following data, which can be read by the controllers. Note that 1 = ON/Normal and 0 = OFF/Fault/Alarm.

- Individual Point Input Status
- Combined Input Status
- Individual Point Output Status
- Combined Output Status
- Individual Test Output Status
- Individual Output Readback (actual ON/OFF state of the outputs)

Status data indicates whether each safety input, safety output, or test output is normal (normal status: ON, faulted status: OFF). For fatal errors, communication connections may be broken, so the status data cannot be read. Status bits are OFF in the GuardLogix data table when the connection is lost.

Combined status is provided by an AND of the status of all safety inputs or all safety outputs. When all inputs or outputs are normal the respective combined status is ON. When one or more of them has an error, the respective combined status is OFF. This is known as the combined safety input status or combined-safety output status.

Safety Inputs

Read this section for information about safety inputs and their associated test outputs. A safety input may be used with test outputs. Safety inputs are used to monitor safety input devices.

Using a Test Output with a Safety Input

A test output can be used in combination with a safety input for short circuit detection. Configure the test output as a pulse test source and associate it to a specific safety input.

The test output can also be configured for a power supply to source 24V DC for an external device, for example, a light curtain.

Figure 11 - Example Use of a 1791DS-IB12 Module

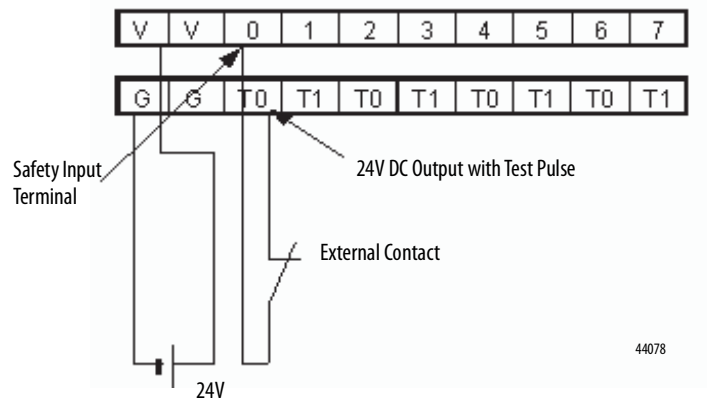

Cat. No.	Pulse Width (X)	Pulse Period (Y)
1732DS-IB8	500 μ s	600 ms
1732DS-IB8X0BV4	500 μ s	600 ms
1791DS-IB12	700 μ s	648 ms
1791DS-IB8X0B8	700 μ s	648 ms
1791DS-IB4X0W4	700 μ s	648 ms
1791DS-IB8X0BV4	500 μ s	600 ms
1791DS-IB16	500 μ s	600 ms

Figure 12 - Test Pulse in a Cycle

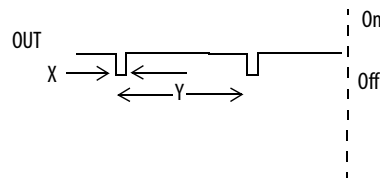

When the external input contact is closed, a test pulse is output from the test output terminal to diagnose the field wiring and input circuitry. Using this function, short-circuits between input signal lines and the power supply (positive side), and short-circuits between input signal lines can be detected.

Figure 13 - Short-circuit Between Input Signal Lines

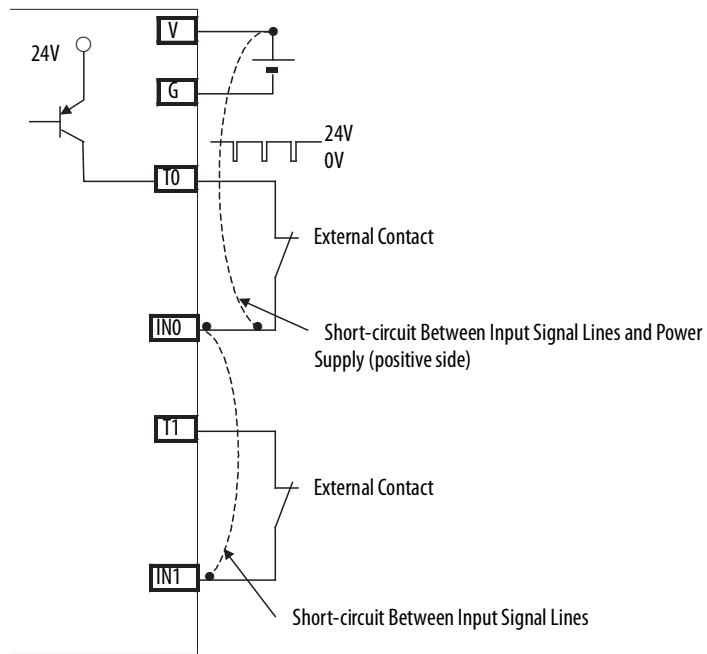

44079

Single Channel Mode

If an error is detected, safety input data and safety input status turn off.

Figure 14 - Normal Operation and Fault Detection (not to scale)

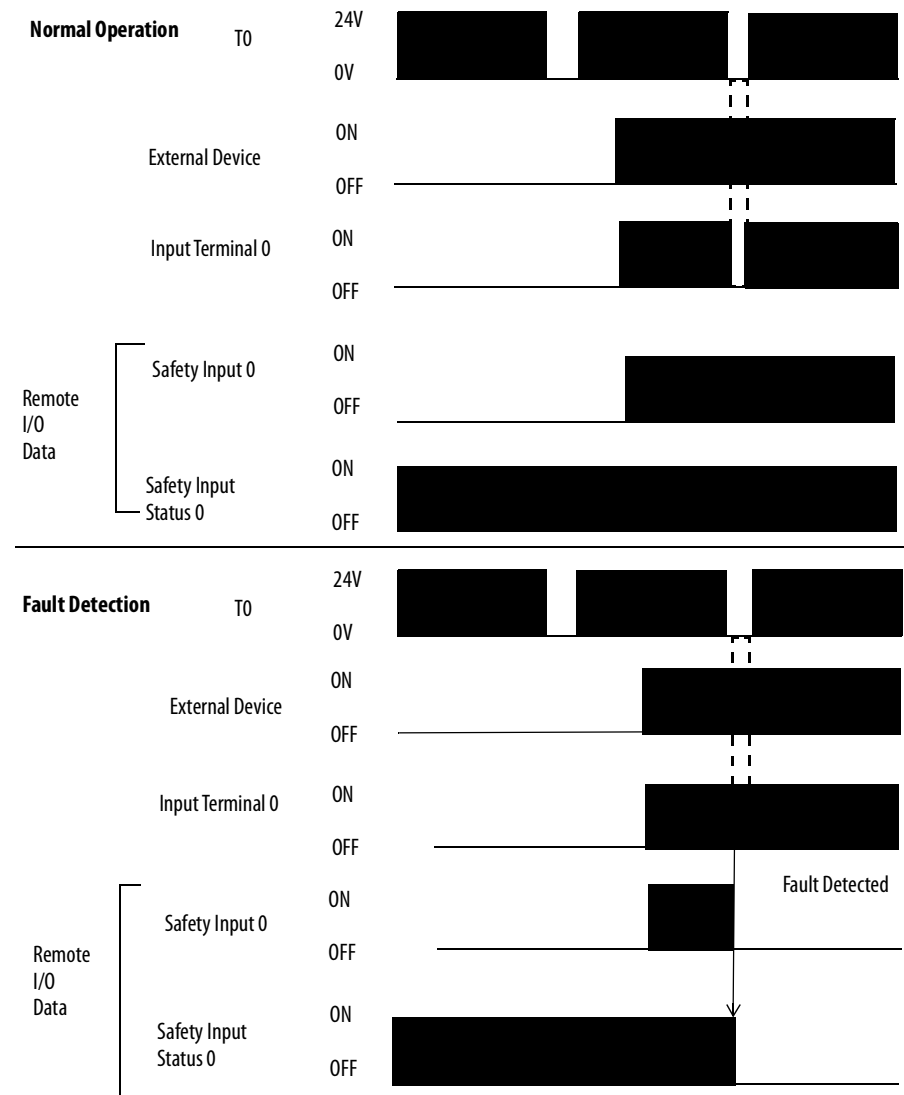

Dual-channel Mode and Discrepancy Time

To support redundant-channel safety devices, the consistency between signals on two channels can be evaluated. Either equivalent or complementary can be selected. This function monitors the time during which there is a discrepancy between the two channels.

If the length of the discrepancy exceeds the configured discrepancy time (0...65,530 ms in increments of 10 ms), the safety input data and the individual-safety input status turns off for both channels.

IMPORTANT The dual-channel function is used with two consecutive inputs that are paired together, starting at an even input number, such as inputs 0 and 1, 2 and 3, and so on.

IMPORTANT Do not set the discrepancy time longer than necessary. The purpose of the discrepancy time is to allow for normal differences between contact switching when demands are placed on safety inputs. For this testing to operate correctly, only a single demand on the safety input is expected during the discrepancy time. If the discrepancy time is set too high, and multiple demands occur during this time, then both safety input channels will fault.

This table shows the relation between input terminal states and controller input data and status.

Table 1 - Terminal Input Status and Controller I/O Data

Dual-channel Mode	Input Terminal		Controller Input Data and Status				Dual-channel Resultant Data	Dual-channel Resultant Status
	IN0	IN1	Safety Input 0 Data	Safety Input 1 Data	Safety Input 0 Status	Safety Input 1 Status		
Dual-channels, Equivalent	OFF	OFF	OFF	OFF	ON	ON	OFF	Normal
	OFF	ON	OFF	OFF	OFF	OFF	OFF	Fault
	ON	OFF	OFF	OFF	OFF	OFF	OFF	Fault
	ON	ON	ON	ON	ON	ON	ON	Normal
Dual-channels, Complementary	OFF	OFF	OFF	ON	OFF	OFF	OFF	Fault
	OFF	ON	OFF	ON	ON	ON	OFF	Normal
	ON	OFF	ON	OFF	ON	ON	ON	Normal
	ON	ON	OFF	ON	OFF	OFF	OFF	Fault

Dual-channels, Equivalent

In Equivalent mode, both inputs of a pair should typically be in the same (equivalent) state. When a transition occurs in one channel of the pair prior to the transition of the second channel of the pair, a discrepancy occurs. If the second channel transitions to the appropriate state prior to the discrepancy time elapsing, the inputs are considered equivalent. If the second transition does not occur before the discrepancy time elapses, the channels will fault. In the fault state the input and status for both channels are set low (off). When configured as an

equivalent dual pair, the data bits for both channels will always be sent to the controller as equivalent, both high or both low.

Figure 15 - Equivalent, Normal Operation and Fault Detection (not to scale)

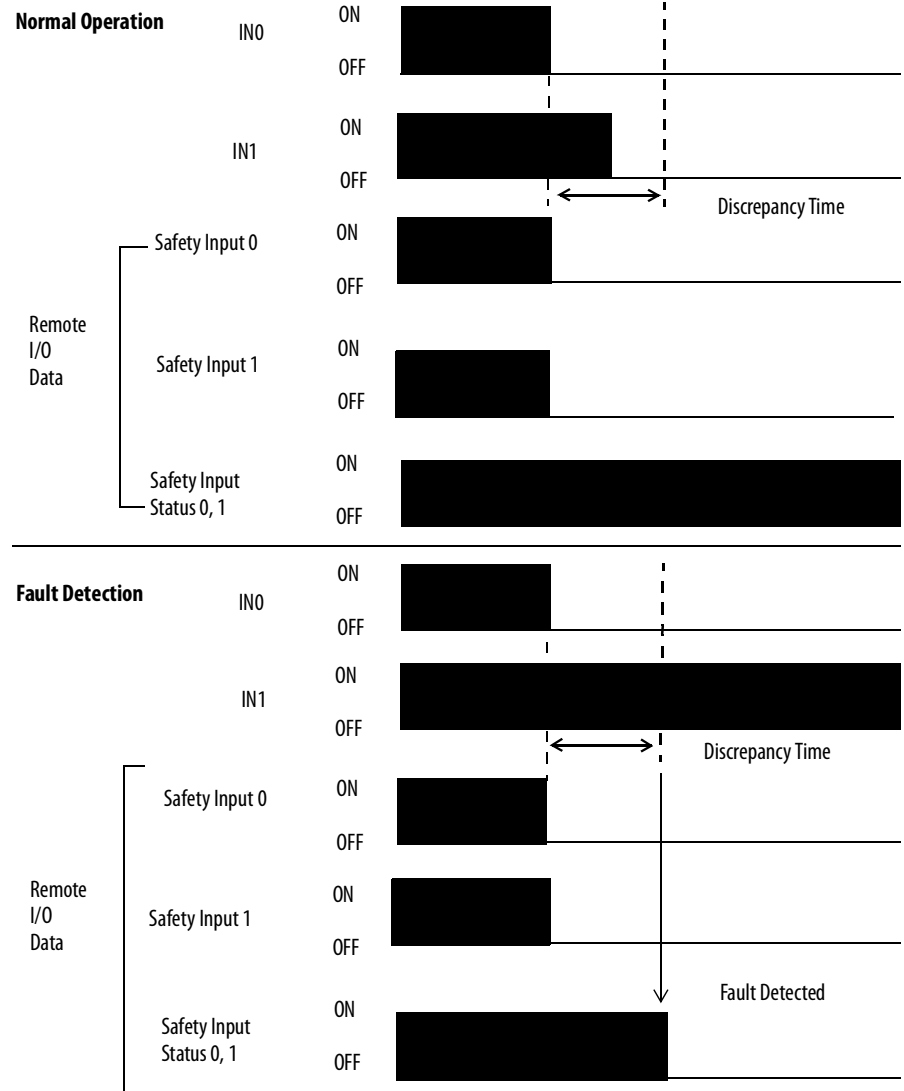

Dual-channels, Complementary

In Complementary mode, the inputs of a pair should typically be in the opposite (complementary) state. When a transition occurs in one channel of the pair prior to the transition of the second channel of the pair, a discrepancy occurs. If the second channel transitions to the appropriate state prior to the discrepancy time elapsing, the inputs are considered complementary.

If the second transition does not occur before the discrepancy time elapses, the channels will fault. The fault state of complementary inputs is the even-numbered input turned off and the odd-numbered input turned on. Note that if faulted, both channel status bits are set low. When configured as a

complementary dual-channel pair, the data bits for both channels will always be sent to the controller in complementary, or opposite states.

Figure 16 - Complementary, Normal Operation and Fault Detection (not to scale)

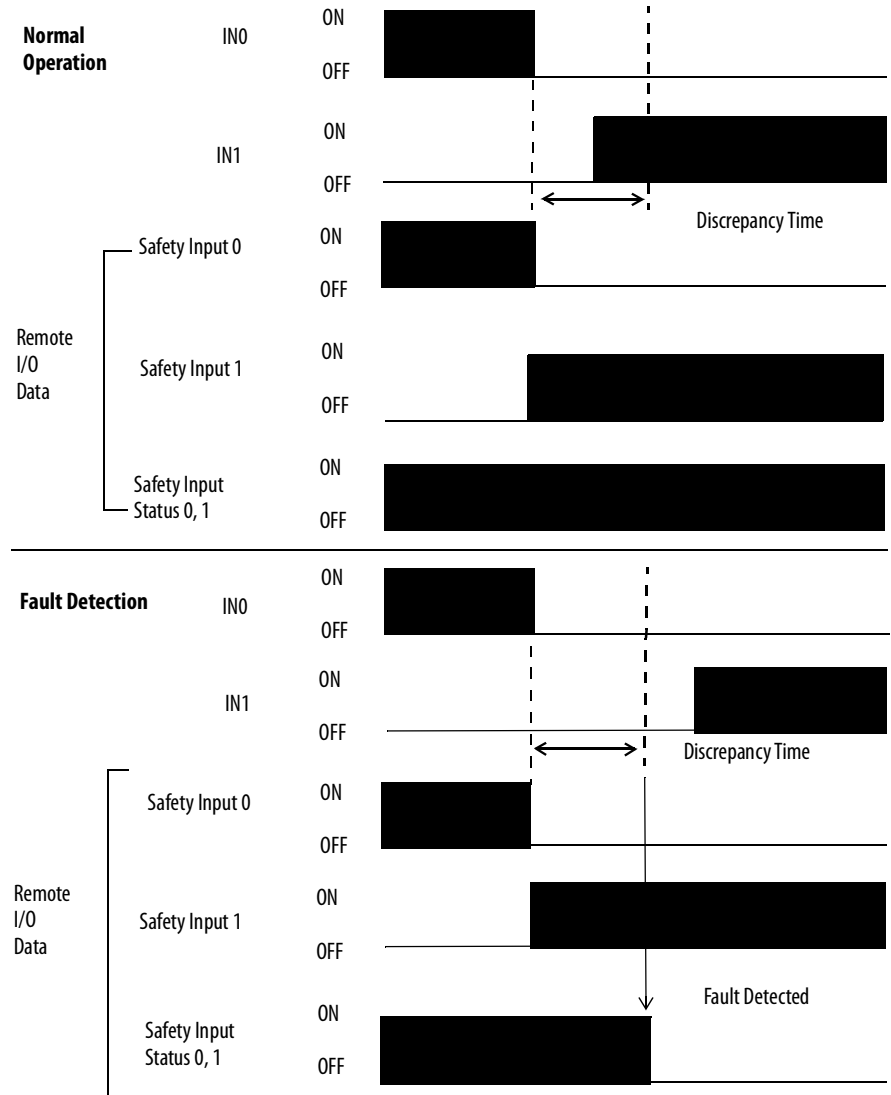

Safety Input Fault Recovery

If an error is detected, the safety input data remains in the off state. Follow this procedure to activate the safety input data again.

1. Remove the cause of the error.
2. Place the safety input (or safety inputs) into the safe state.

The safety input status turns on (fault cleared) after the input-error latch time has elapsed and the I/O indicator (red) turns off. The input data can now be controlled.

Input Delays

On-delay - An input signal is treated as Logic 0 during the on-delay time (0...126 ms, in increments of 6 ms) after the input contact's rising edge. The input turns on only if the input contact remains on after the on-delay time has elapsed. This helps prevent rapid changes of the input data due to contact bounce.

Figure 17 - On-delay

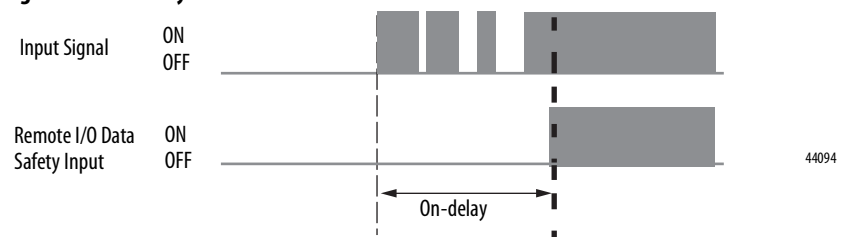

Off-delay - An input signal is treated as Logic 1 during the off-delay time (0...126 ms, in increments of 6 ms) after the input contact's falling edge. The input turns off only if the input contact remains off after the off delay time has elapsed. This helps prevent rapid changes of the input data due to contact bounce.

Figure 18 - Off-delay

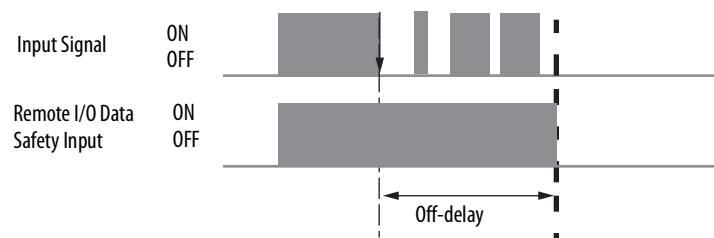

Test Outputs Configured as Muting Outputs

When test outputs are used as muting outputs, typically for a muting lamp, a circuit test is used to diagnose whether the circuit and lamp are operational. The muting circuit test is run every 3 seconds, regardless of whether the circuit is logic HI or LO. This could cause your muting output to flicker during normal operation when it is logic LO.

The muting circuit test must fail twice in succession when the muting circuit is logically HI, before a fault is declared. The results of the muting circuit test do not affect the muting status when the circuit is logically LO.

A muting circuit fault will cause the muting status bit to go LO.

A muting circuit fault is declared 3...6 seconds after the fault occurs if the muting circuit is logically HI for at least 6 seconds, because of the 3-second test interval and that the muting circuit test must fail twice in succession. If the muting circuit is logically HI for less than 6 seconds during a machine cycle, then the asynchronous test and program scans could cause the fault detection to be delayed for several machine cycles.

There is a difference in the operation of the muting status between some of the DeviceNet safety I/O modules. This table shows the operation of the muting status of all modules.

Cat. No.	Lamp	Circuit	Description
1791DS-IB16 ⁽¹⁾	HI	Good	Muting status HI/1
1791DS-IB8XOBV4 ⁽¹⁾			
1732DS-IB8 ⁽¹⁾			
1732DS-IB8XOBV4 ⁽¹⁾		Bad	Muting status LO 1 second/HI 5 seconds (repeats)
	LO status typically appears 3...6 seconds after fault		
	LO	Good	Muting status LO/0
		Bad	Muting status LO/0
1791DS-IB12	HI	Good	Muting status HI/1
1791DS-IB8XOB8			
1791DS-IB4XOW4		Bad	Muting status Lo 1 second/HI 5 seconds (repeats)
			Muting status resets automatically
	LO	Good	Muting status HI/1
		Bad	Muting status HI/1

(1) This module's muting status bit goes LO when a fault occurs **or** when the circuit is logically LO.

For catalog numbers 1791DS-IB16, 1791DS-IB8XOBV4, 1732DS-IB8, and 1732DS-IB8XOBV4, when using these GuardLogix safety application instructions that monitor muting, should include the following codes to operate properly when the muting status bit goes LO if the circuit is logically LO:

- DCSTM
- FSBM
- TSAM
- TSSM

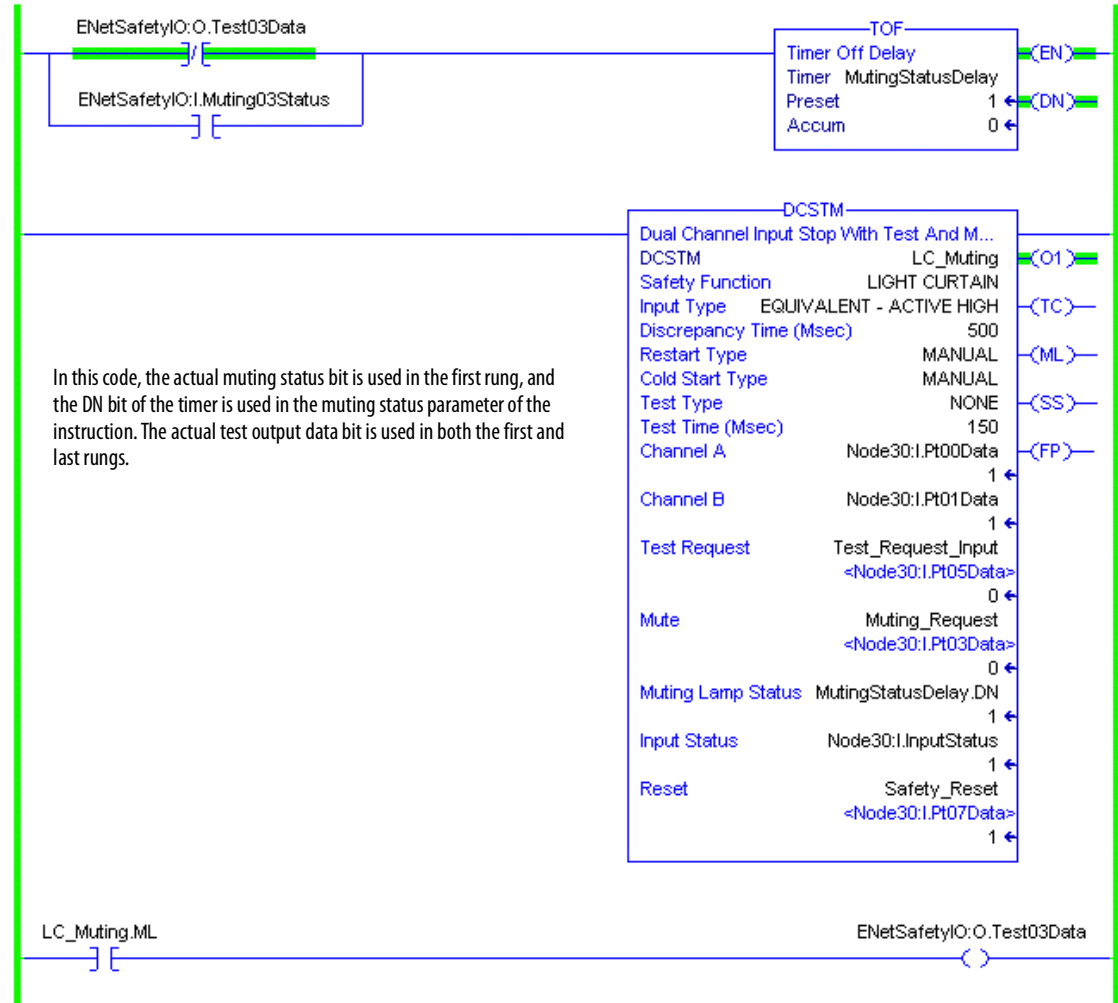

Safety Outputs

Read this section for information about safety outputs.

Safety Output with Test Pulse

When the safety output is on, the safety output can be test pulsed, as shown in the figure and table.

Using this function, short-circuits between output signal lines and the power supply (positive side) and short-circuits between output signal lines can be detected. If an error is detected, the safety output data and individual safety output status turn off.

Cat. No.	Pulse Width (X)	Pulse Period (Y)
1732DS-IB8	Not applicable	Not applicable
1732DS-IB8X0BV4	700 μ s	600 ms
1791DS-IB12	Not applicable	Not applicable
1791DS-IB8X0B8	470 μ s	648 ms
1791DS-IB4X0W4	Not applicable	Not applicable
1791DS-IB8X0BV4	700 μ s	600 ms
1791DS-IB16	Not applicable	Not applicable

Figure 19 - Test Pulse in a Cycle

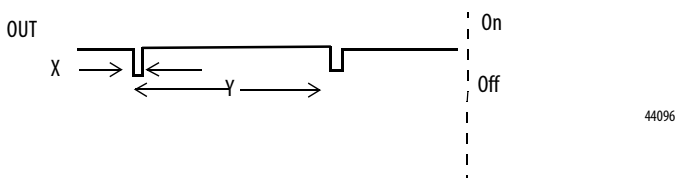

IMPORTANT To prevent the test pulse from causing the connected device to malfunction, pay careful attention to the input response time of the device.

Dual-channel Setting

When the data of both channels is in the on state, and neither channel has a fault, the outputs are turned on. The status is normal. If a fault is detected on one channel, the safety output data and individual safety output status turn off for both channels.

Figure 20 - Dual-channel Setting (not to scale)

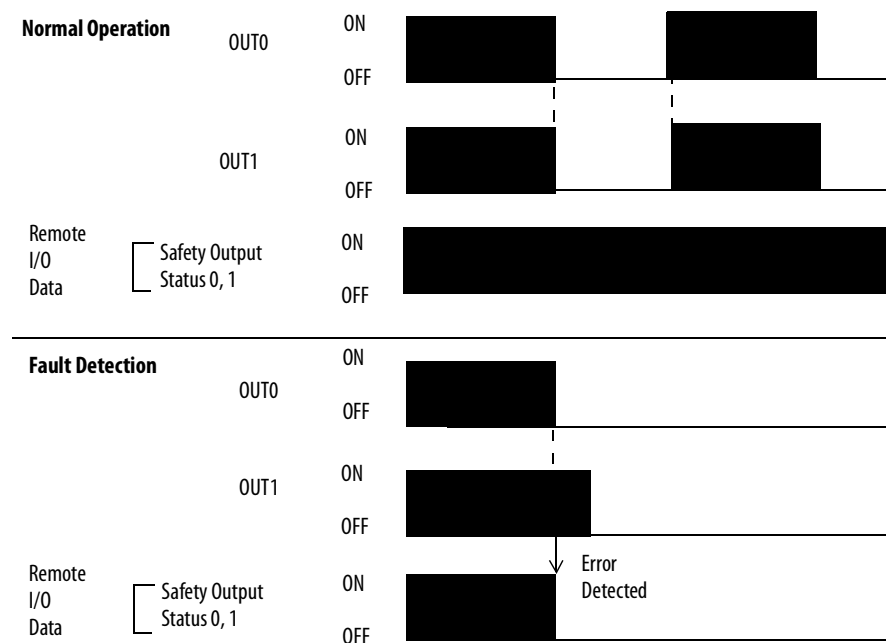

Safety Output Fault Recovery

If a fault is detected, the safety outputs are switched off and remain in the off state. Follow this procedure to activate the safety output data again.

1. Remove the cause of the error.
2. Place the safety output (or safety outputs) into the safety state.

The safety output status turns on (fault cleared) when the output-error latch time has elapsed. The I/O indicator (red) turns off. The output data can now be controlled.

Controlling Devices

See this table for information about controlling devices.



ATTENTION: Use appropriate devices as indicated in the Controlling Device Requirements table. Serious injury may occur due to loss of safety functions.

Table 2 - Controlling Device Requirements

Device	Requirement	Allen-Bradley Bulletin Safety Components
Emergency stop switches	Use approved devices with direct opening mechanisms complying with IEC/EN 60947-5-1.	Bulletin 800F, 800T
Door interlocking switches, limit switches	Use approved devices with direct opening mechanisms complying with IEC/EN 60947-5-1 and capable of switching microloads of 24V DC, 3 mA.	Bulletin 440K, 440G, 440H for interlock switch Bulletin 440P, 802T for limit switch
Safety sensors	Use approved devices complying with the relevant product standards, regulations, and rules in the country where used.	Guardmaster products, refer to specific product publications for details
Relays with forcibly- guided contacts, contactors	Use approved devices with forcibly-guided contacts complying with EN 50205. For feedback purposes, use devices with contacts capable of switching micro loads of 24V DC, 3 mA.	Bulletin 700S, 100S
Other devices	Evaluate whether devices used are appropriate to satisfy the requirements of safety category levels.	-

Safety Precautions



ATTENTION: As serious injury may occur due to loss of required safety function, follow these safety precautions.

- Do not use test outputs of the modules as safety outputs.
- Do not use DeviceNet standard I/O data or explicit message data as safety data.
- Do not use LED status indicators on the I/O modules for safety operations.
- Do not connect loads beyond the rated value to the safety outputs.
- Wire the Guard I/O modules properly so that 24V DC line does not touch the safety outputs accidentally or unintentionally.
- Clear previous configuration data before connecting devices to the network.
- Set unique DeviceNet node addresses before connecting devices to the network.
- Perform testing to confirm that all of the device configuration data and operation is correct before starting system operation.
- When replacing a device, configure the replacement device suitably and confirm that it operates correctly.
- When installing or replacing modules, clear any previous configuration before connecting input or output power to the device.

Legislation and Standards

Read this section to familiarize yourself with related legislation and standards information. Relevant international standards include the following:

- IEC 61508 (SIL 1-3)
- IEC 61131-2
- IEC 60204-1
- IEC 61000-6-2
- IEC 61000-6-4
- IEC 62061

The modules received the following certification from ODVA, when product is marked.

- DeviceNet Conformance Test
- DeviceNet Safety Conformance Test

Europe

In Europe, Guard I/O modules may be subject to the European Union (EU) Machinery Directive Annex IV, B, Safety Components, items 1 and 2. The type approval of TUV-Rheinland addresses compliance to applicable requirements of the following directives and standards.

- EU legislation
 - Machinery Directive
 - Low-voltage Directive
 - EMC Directive
- European standards
 - EN 61508 (SIL1-3)
 - EN 954-1 (Category 4, 3, 2, 1, B)
 - EN 61131-2
 - EN 418
 - EN 60204-1
 - IEC 61000-6-2
 - IEC 61000-6-4
 - IEC 13849

North America

In North America, the TUV-Rheinland type approval includes Guard I/O compliance to the relevant standards and related information including the following:

- U.S. standards - ANSI RIA15.06, ANSI B11.19, NFPA 79
- The modules are UL-certified functionally safe and carry the NRGF label, when product is marked.
- The modules received UL Listing to standards of U.S. and Canada when product is marked.

Japan

In Japan, type test requirements are provided in Article 44 of the Industrial Safety and Health Law. These requirements apply to complete systems and cannot be applied to a module by itself. Accordingly, to use the module in Japan as a safety device for press machine or shearing tool pursuant to Article 42 of the above-mentioned law, it is necessary to apply for testing of the entire system.

EC Directives

These products conform to the EMC Directive and Low-voltage Directive. For additional information, refer to the relevant installation instructions.

EMC Directive

Rockwell Automation devices that comply with EC directives also conform to the related EMC standards so that they can more easily be built into other devices or the overall machine. The actual products have been checked for conformity to EMC standards. Whether they conform to the standards in the system used by the customer, however, must be confirmed by the customer.

EMC-related performance of Rockwell Automation devices that comply with EMC directive vary depending on the configuration, wiring, and other conditions of the equipment or control panel in which the Rockwell Automation devices are installed. The customer must, therefore, perform the final check to confirm that devices and the overall machine conform to EMC standards.

Compliance with EC Directives

DeviceNet products that comply with EC directives must be installed as follows:

- All Type IP20 DeviceNet units must be installed within control panels.
- Use reinforced insulation or double insulation for the DC power supplies used for the communication power supply, internal- circuit power supply, and the I/O power supplies.
- DeviceNet products that comply with EC directives also conform to the Common Emission Standard (EN 50081-2). Radiated emission characteristics (10-m regulations) may vary depending on the configuration of the control panel used, other devices connected to the control panel, wiring, and other conditions. You must confirm that the overall machine or equipment complies with EC directives.

Examples to Reduce Noise

These examples show how to reduce noise in 1791DS-IB12, 1791DS-IB8XOB8, and 1791DS-IB4XOW4 modules.

EXAMPLE

Reduce electrical noise from the communication cable by installing a ferrite core on the communication cable within 10 cm (3.93 in.) of the DeviceNet master unit. Use Ferrite Core (Data Line Filter) LF130B, manufactured by Easy Magnet Co., or an equivalent.

Impedance Specifications

Impedance Value

25 MHz 100 MHz

156 Ω 250 Ω

Ferrite Core

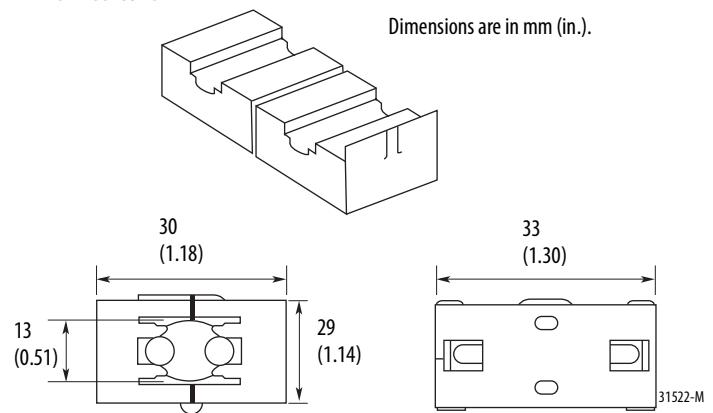

EXAMPLE

Wire the control panel with cables that are as short as possible and ground to 100 Ω or less.

EXAMPLE

Keep DeviceNet communication cables as short as possible and ground to 100 Ω or less.

Install and Connect Your Modules

Topic	Page
Considerations for Module Installation	43
Install the Module	44
Connect I/O Power and I/O Cables	45
Connect Communication Connectors	46
Set the Node Address	46

Considerations for Module Installation

The communication baud rate of the entire network is determined by the communication baud rate of the master unit. The communication baud rate does not need to be set for each module.



ATTENTION: You can configure Test Outputs to be used as standard outputs. You can connect actuators to Test Output points that are expecting a Standard configuration.

ATTENTION: Test Output points configured as Pulse Test or Power Supply become active whenever you apply input power to the module. These configured functions are independent of the I/O connections to the module.



ATTENTION: If a module with Test Outputs configured as Pulse Test or Power Supply is incorrectly installed in an application where actuators are connected to these Test Output points, the actuators will be activated when network power and input power are applied.

ATTENTION: To prevent this possibility, use the following procedures:

- When installing a module, be sure that the module is correctly configured for the application or in the out-of-box condition before applying input power.
- When replacing a module, be sure that the module is correctly configured for the application or in the out-of-box condition before applying input power.
- Reset modules to their out-of-box condition when removing them from an application.
- Be sure that all modules in replacement stock are in their out-of-box condition.

Install the Module

IMPORTANT

Follow these instructions when installing a module:

- Use the module in an environment that is within the general specifications.
- Use the 1791DS modules in an enclosure rated IP54 (IEC60529) or higher.
- Use DIN rail that is 35 mm (1.38 in.) wide to mount the 1791DS module in the control panel.
- Always use an end plate on each end of the 1791DS modules to secure properly.
- Place other heat sources an appropriate distance away from the module to maintain ambient temperatures around the module below specified maximums.

See the figures for required spacing for module installation.

IMPORTANT

You can install modules horizontally or vertically.

Figure 21 - Module Installation (1791DS-IB12, 1791DS-IB8X0B8, and 1791DS-IB4X0W4 modules)

35 (1.38)

Dimensions are in mm (in.).

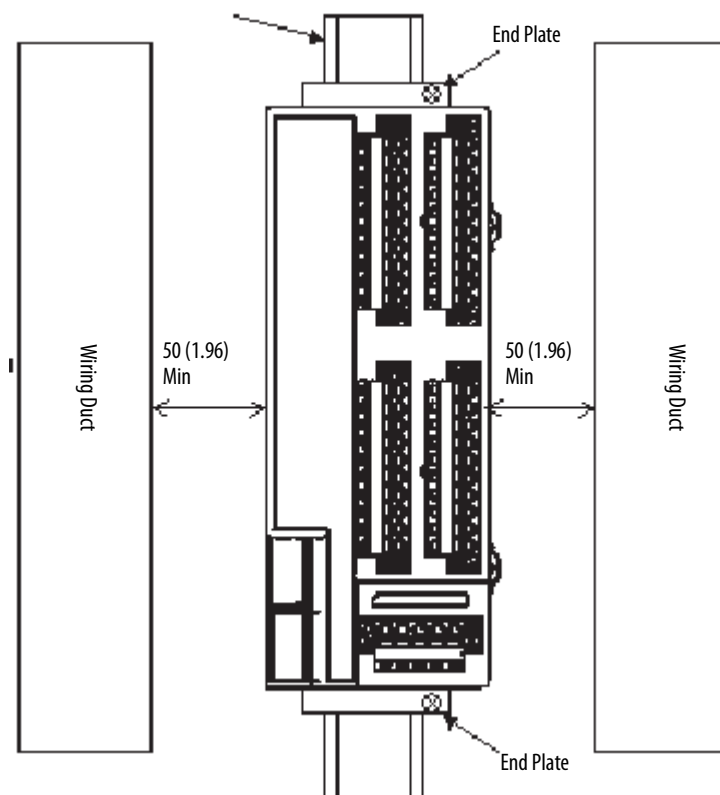
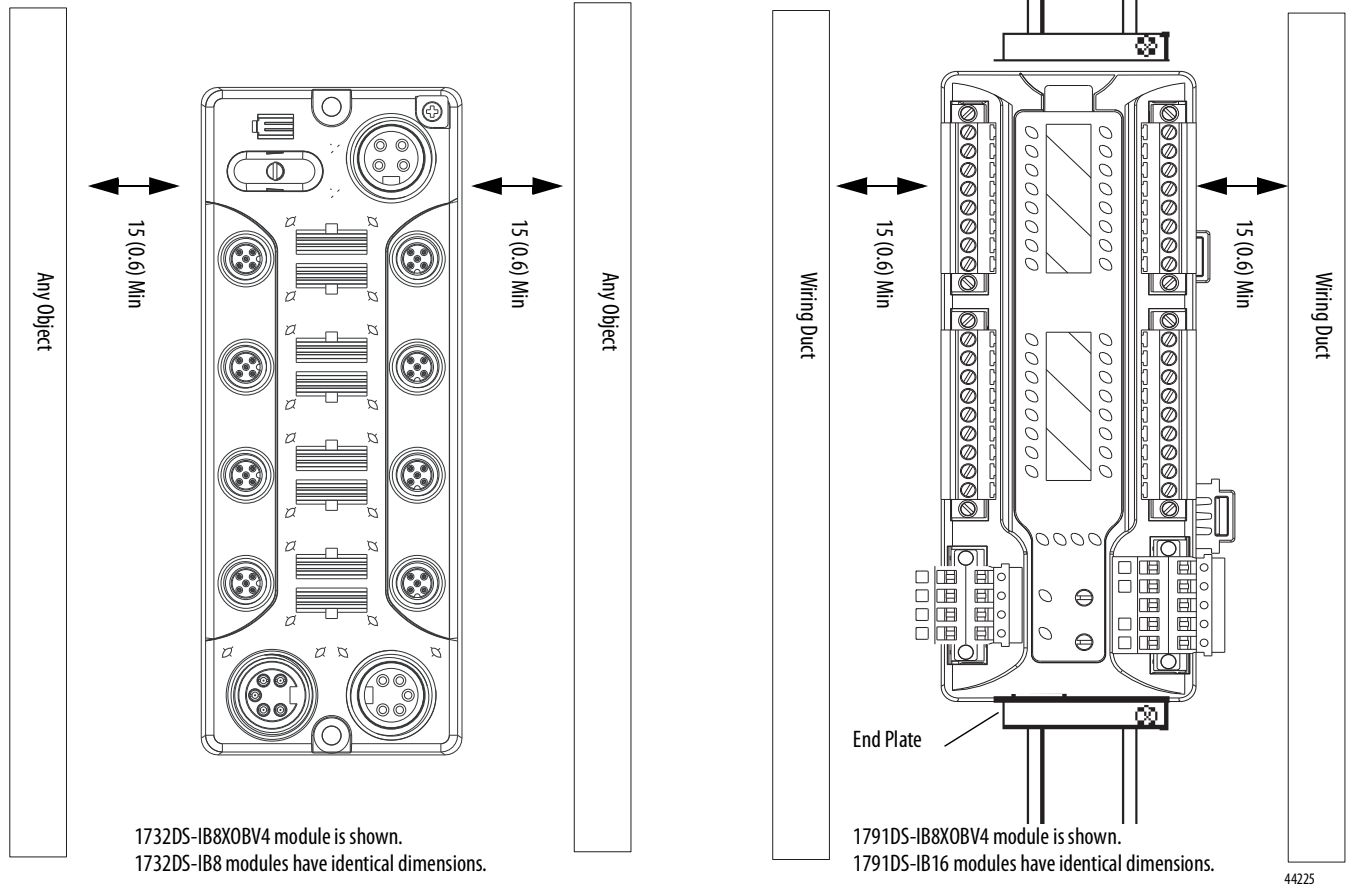

Figure 22 - Module Installation

Dimensions are in mm (in.).



Connect I/O Power and I/O Cables

See module installation instructions for wire type and wire size specifications.

IMPORTANT

- Note that I/O connectors are detachable.
- Tighten the screws on the I/O connector to the specified torque setting as shown in the installation instructions.
- Since the I/O connector has a structure that helps prevent incorrect wiring, make connections at the specified locations corresponding to the terminal numbers.
- When present, do not remove debris shield from the module before wiring.
- When present, always remove the debris shield after completing wiring to be sure of proper heat dispersion.

Connect Communication Connectors

Colored stickers on the communication connector match the colors of the wires to be inserted. Check that the colors of the wires match when wiring the connectors. The colors are as follows.

Color	Signal
Red	Power cable positive side (V+)
White	High side of communication data (CAN_H)
-	Shield
Blue	Low side of communication data (CAN_L)
Black	Power cable negative side (V-)

IMPORTANT

When connecting a communication connector with the module, tighten the screws on the communication connector to the specified torque setting as shown in the installation instructions.

The internal power for the module is supplied from the communication power supply (V+, V-).

Set the Node Address

To set the node address, follow this procedure.

IMPORTANT

The node-address setting rotary switches must be set while the communication power supply is turned off.

Figure 23 - Sample Node Address Digits

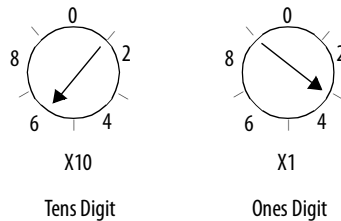

1. Set the node address by using the two rotary switches on the front panel of the module, noting that the default setting is 63 and a value between 00...63 is valid for proper use.
2. Use the left rotary switch to set the tens digit of node address (decimal).
3. Use the right rotary switch to set the ones digit.

If the node address switches are set from 64...99, the node address needs to be set from RSNetWorx for DeviceNet software.

Wiring Examples

Topic	Page
Input Examples	47
Source Output Examples	53
Bipolar Output Examples	55
Relay Output Examples	57
Test Output Examples	59

Read this chapter for information about wiring and safety categories. These examples show wiring and configuration methods for various safety categories used in SIL 2 or SIL 3 systems.

For other wiring examples, refer to the Safety Accelerator Toolkit for GuardLogix Systems CD, publication SAFETY-CL002, or download toolkit files from the Integrated Architecture Tools and Resources website at <http://www.ab.com/go/iatools>.

Input Examples

Read this section for input examples by application. For details, refer to the installation instructions for each catalog number.

Emergency Stop Switch Dual-channel Inputs with Manual Reset

This example shows wiring and controller configuration when using a Guard I/O module with an emergency stop switch that has dual-channel inputs with manual reset. If used in combination with the programs in a safety controller, this wiring is Safety Category 4 in accordance with EN 954-1 wiring requirements.

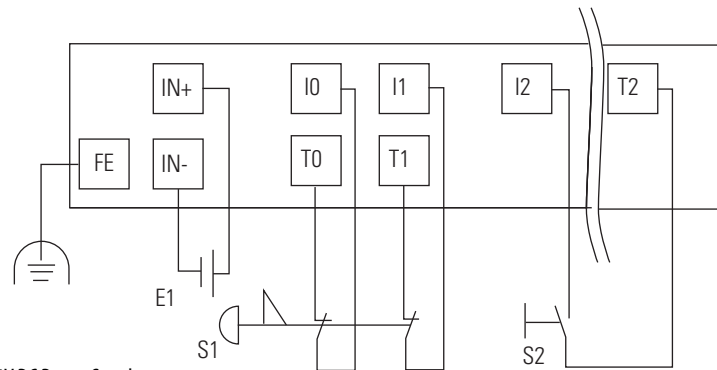

- E1: 24V DC Power Supply
- S1: Emergency Stop Switch
(positive opening mechanism)
- S2: Reset Switch
- FE: Functional Earth Ground

31802-M

Controller Configuration	Parameter Name	Configuration Setting
Safety Input 0	Safety Input 0 Channel Mode	Test Pulse from Test Output
	Safety Input 0 Test Source	Test Output 0
	Dual-channel Safety Input 0/1 Mode	Dual-channel Equivalent
	Dual-channel Safety Input 0/1 Discrepancy Time	100 ms (application dependent)
Safety Input 1	Safety Input 1 Channel Mode	Test Pulse from Test Output
	Safety Input 1 Test Source	Test Output 1
Safety Input 2	Safety Input 2 Channel Mode	Used as Standard Input
	Safety Input 2 Test Source	Not Used
	Dual-channel Safety Input 2/3 Mode	Single Channel
Test Output 0	Test Output 0 Mode	Pulse Test Output
Test Output 1	Test Output 1 Mode	Pulse Test Output
Test Output 2	Test Output 2 Mode	Power Supply Output

Two-hand Monitor

This example shows wiring and controller configuration when using a Guard I/O module with a two-hand monitor. If used in combination with the programs in a safety controller, this wiring is Safety Category 4 in accordance with EN 954-1 wiring requirements.

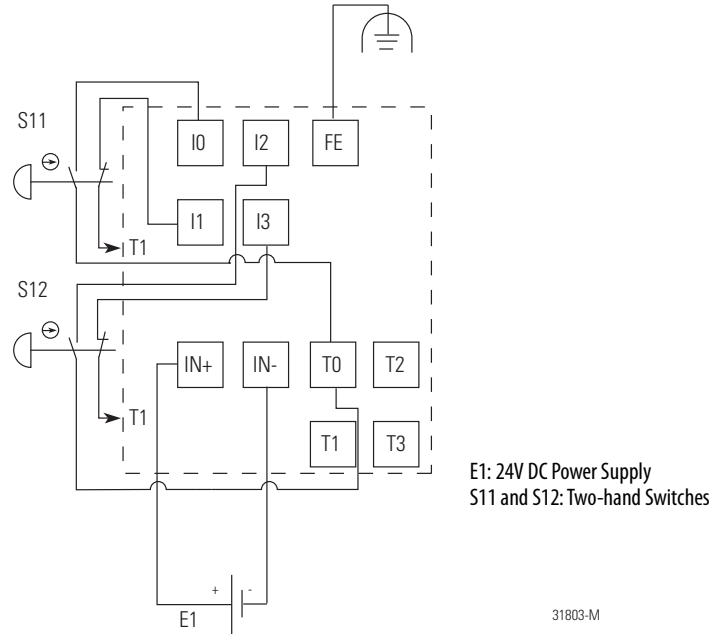

Controller Configuration	Parameter Name	Configuration Setting
Safety Input 0	Safety Input 0 Channel Mode	Test Pulse from Test Output
	Safety Input 0 Test Source	Test Output 0
	Dual-channel Safety Input 0/1 Mode	Dual-channel Complementary
	Dual-channel Safety Input 0/1 Discrepancy Time	100 ms (application dependent)
Safety Input 1	Safety Input 1 Channel Mode	Test Pulse from Test Output
	Safety Input 1 Test Source	Test Output 1
Safety Input 2	Safety Input 2 Channel Mode	Test Pulse from Test Output
	Safety Input 2 Test Source	Test Output 0
	Dual-channel Safety Input 2/3 Mode	Dual-channel Complementary
	Dual-channel Safety Input 2/3 Discrepancy Time	100 ms (application dependent)
Safety Input 3	Safety Input 3 Channel Mode	Test Pulse from Test Output
	Safety Input 3 Test Source	Test Output 1
Test Output 0	Test Output 0 Mode	Pulse Test Output
Test Output 1	Test Output 1 Mode	Pulse Test Output

Mode Select Switch

This example shows wiring and controller configuration when using a Guard I/O module with a mode select switch.

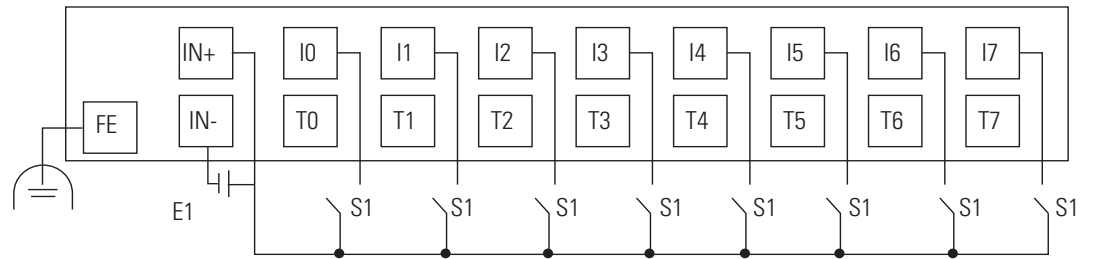

E1: 24V DC Power Supply
 S1: Mode Select Switch
 FE: Functional Earth Ground

31804-M

Controller Configuration	Parameter Name	Configuration Setting
Safety Input 0	Safety Input 0 Channel Mode	Safety Input
	Safety Input 0 Test Source	None
	Dual-channel Safety Input 0/1 Mode	Single Channel
Safety Input 1	Safety Input 1 Channel Mode	Safety Input
	Safety Input 1 Test Source	None
Safety Input 2	Safety Input 2 Channel Mode	Safety Input
	Safety Input 2 Test Source	None
	Dual-channel Safety Input 2/3 Mode	Single Channel
Safety Input 3	Safety Input 3 Channel Mode	Safety Input
	Safety Input 3 Test Source	None
Safety Input 4	Safety Input 4 Channel Mode	Safety Input
	Safety Input 4 Test Source	None
	Dual-channel Safety Input 4/5 Mode	Single Channel
Safety Input 5	Safety Input 5 Channel Mode	Safety Input
	Safety Input 5 Test Source	None
Safety Input 6	Safety Input 6 Channel Mode	Safety Input
	Safety Input 6 Test Source	None
	Dual-channel Safety Input 6/7 Mode	Single Channel
Safety Input 7	Safety Input 7 Channel Mode	Safety Input
	Safety Input 7 Test Source	None

Light Curtain

This example shows wiring and controller configuration when using a Guard I/O module with a light curtain. If used in combination with the programs in a safety controller, this wiring is Safety Category 2, 3, or 4, based on the light curtain being used, in accordance with EN 954-1 wiring requirements.

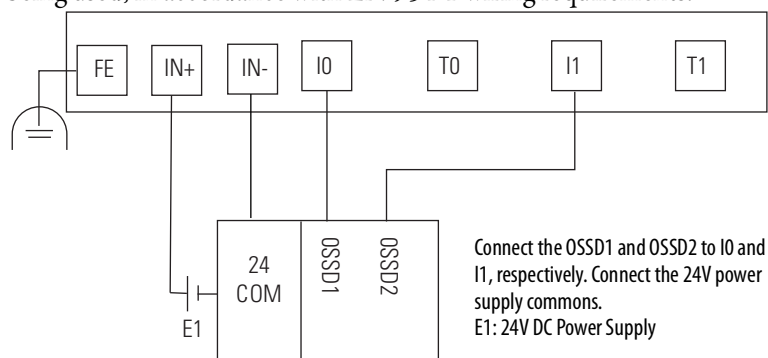

31805-M

Controller Configuration	Parameter Name	Configuration Setting
Safety Input 0	Safety Input 0 Channel Mode	Safety
	Safety Input 0 Test Source	None
	Dual-channel Safety Input 0/1 Mode	Dual-channel Equivalent
	Dual-channel Safety Input 0/1 Discrepancy Time	100 ms (application dependent)
Safety Input 1	Safety Input 1 Channel Mode	Safety
	Safety Input 1 Test Source	None

Reset Switch

These examples show wiring and controller configuration when using a Guard I/O module with a reset switch.

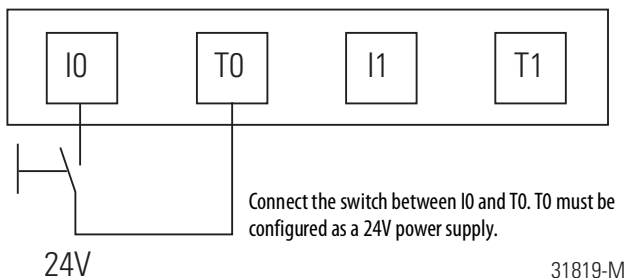

Controller Configuration	Parameter Name	Configuration Setting
Safety Input 0	Safety Input 0 Channel Mode	Standard
	Safety Input 0 Test Source	None
	Dual-channel Safety Input 0/1 Mode	Single channel
Test Output 0	Test Output 0 Mode	Power supply

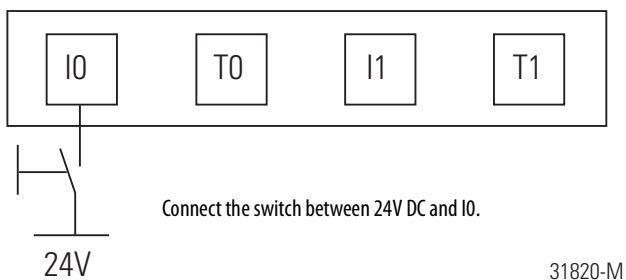

Controller Configuration	Parameter Name	Configuration Setting
Safety Input 0	Safety Input 0 Channel Mode	Standard
	Safety Input 0 Test Source	None
	Dual-channel Safety Input 0/1 Mode	Single channel

Source Output Examples

Read this section for source output examples by application. For details, refer to the installation instructions for each catalog number.

Redundant Safety Contactors

This example shows wiring and controller configuration when using a Guard I/O module with redundant safety contactors.

Note that all safety outputs of this Guard I/O module are permanently configured for use as Dual-channel mode only. When used in combination with the programs of the safety controller, this circuit configuration is Safety Category 4 in accordance with EN 954-1 requirements.

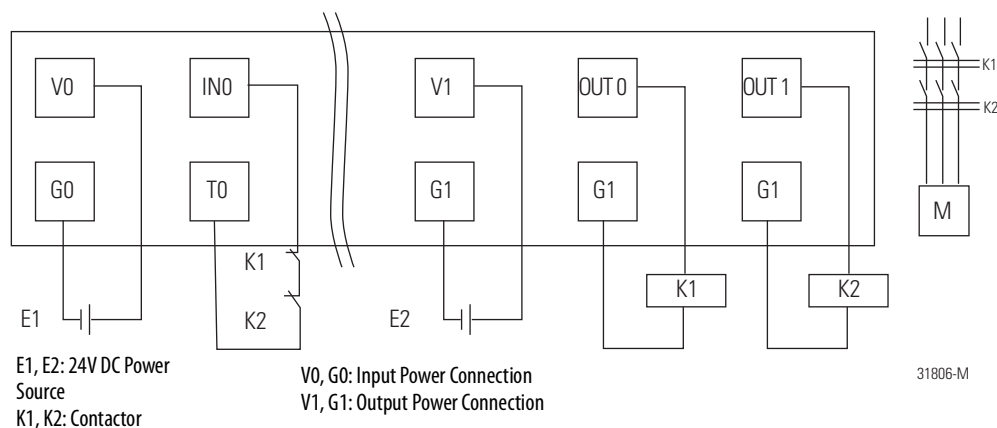

Controller Configuration	Parameter Name	Configuration Setting
Safety Input 0	Safety Input 0 Channel Mode	Test Pulse from Test Output
	Safety Input 0 Test Source	Test Output 0
	Dual-channel Safety Input 0/1 Mode	Single Channel
Test Output 0	Test Output 0 Mode	Pulse Test Output
Safety Output 0	Safety Output 0 Channel Mode	Safety Pulse Test
	Dual-channel Safety Output 0/1 Mode	Dual-channel
Safety Output 1	Safety Output 1 Channel Mode	Safety Pulse Test

Single Channel

This example shows wiring and controller configuration when using a Guard I/O module with a single channel. If used in combination with the programs in a safety controller, this wiring is Safety Category 4 in accordance with EN 954-1 wiring requirements.

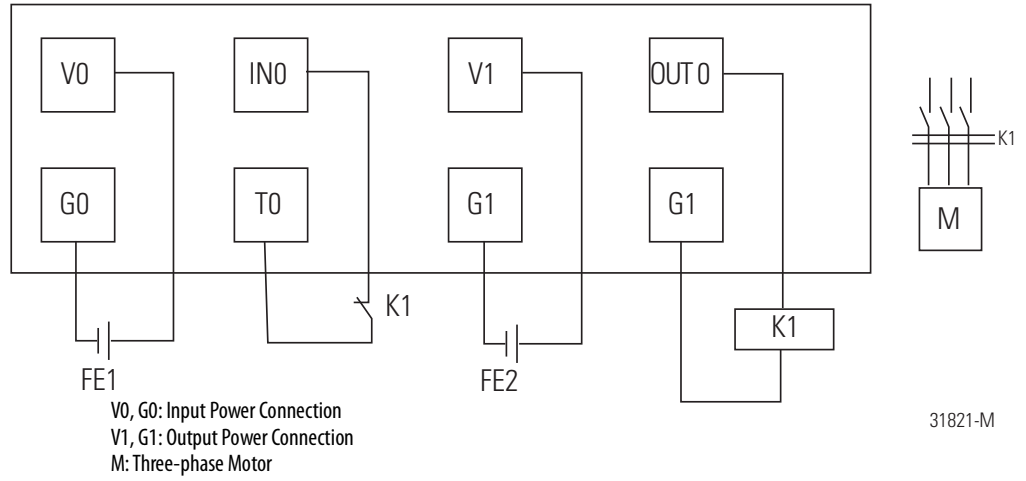

Bipolar Output Examples

Read this section for bipolar output examples by application. For details, refer to the installation instructions for each catalog number.

Dual-load Bipolar Outputs

This example shows wiring and controller configuration when using a Guard I/O module with solid-state outputs in Dual-channel mode.

Note that all safety outputs of this Guard I/O module are permanently configured for use as Dual-channel mode only. When used in combination with the programs of the safety controller, this circuit configuration is Safety Category 4 in accordance with EN 954-1 requirements.

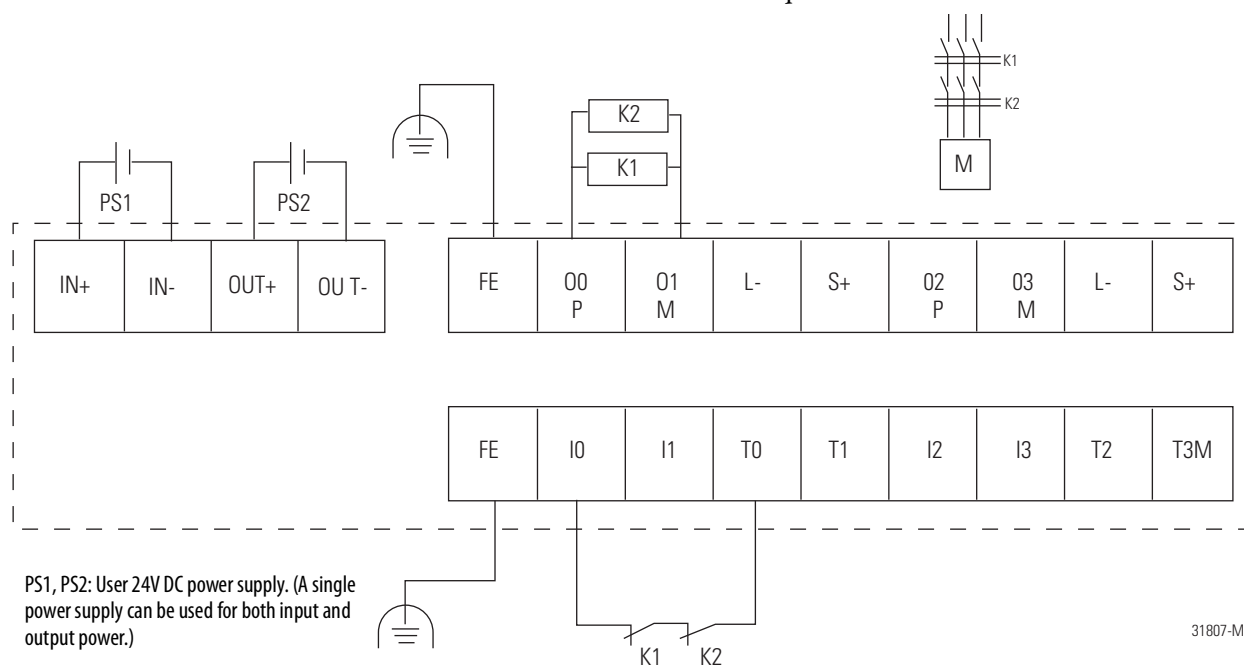

Controller Configuration	Parameter Name	Configuration Setting
Safety Input 0	Safety Input 0 Channel Mode	Test Pulse from Test Output
	Safety Input 0 Test Source	Test Output 0
	Dual-channel Safety Input 0/1 Mode	Single Channel
Test Output 0	Test Output 0 Mode	Pulse Test Output
Safety Output 0	Safety Output 0 Channel Mode	Safety Pulse Test
Safety Output 1	Safety Output 1 Channel Mode	Safety Pulse Test

Single Channel

This example shows wiring and controller configuration when using a Guard I/O module with a single channel. If used in combination with the programs in a safety controller, this wiring is Safety Category 4 in accordance with EN 954-1 wiring requirements.

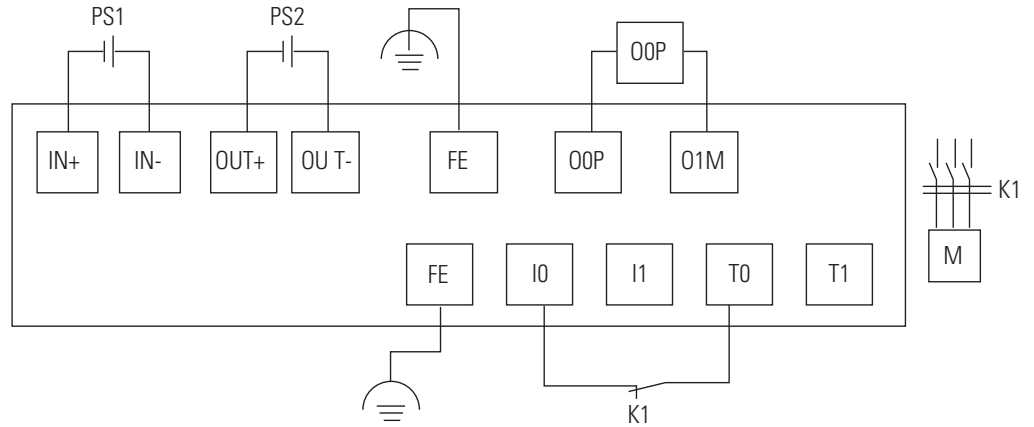

E1, E2: 24V DC Power Source
 K1: Contactor
 M: Three-phase Motor

PS1, PS2: User 24V DC power supply. (A single power supply can be used for both input and output power.)

31822-M

Relay Output Examples

Read this section for relay output examples by application. For details, refer to the installation instructions for each catalog number.

Relay Outputs with Dual-channel Mode and External Device Monitoring Input

This example shows wiring and controller configuration when using a Guard I/O module with relay outputs in dual-channel mode and an external device monitoring input. If used in combination with the programs in a safety controller, this wiring is Safety Category 4 in accordance with EN 954-1 wiring requirements.

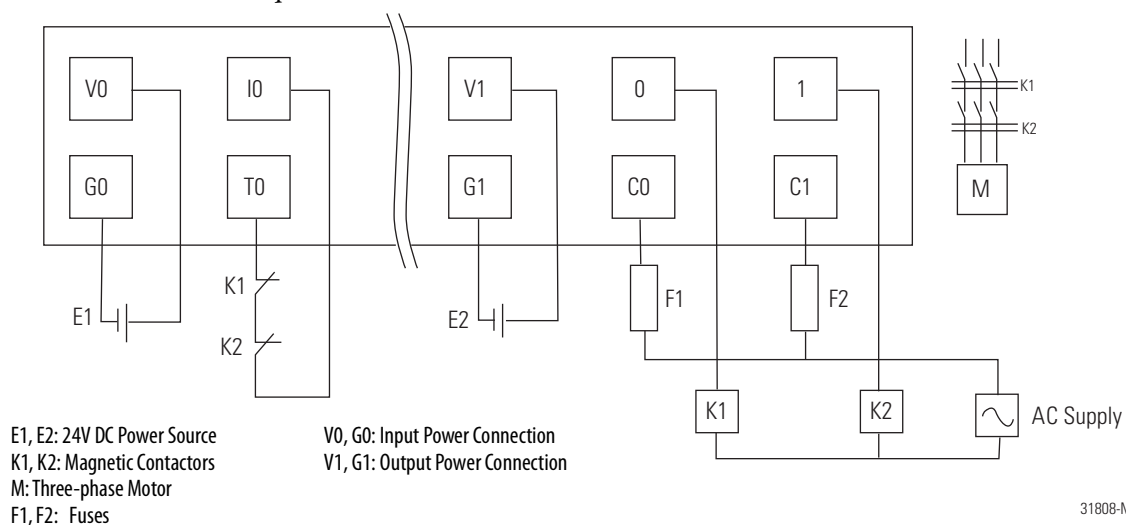

Controller Configuration	Parameter Name	Configuration Setting
Safety Input 0	Safety Input 0 Channel Mode	Test Pulse from Test Output
	Safety Input 0 Test Source	Test Output 0
	Dual-channel Safety Input 0/1 Mode	Single Channel
Test Output 0	Test Output 0 Mode	Pulse Test Output
Safety Output 0	Safety Output 0 Channel Mode	Safety
	Dual-channel Safety Output 0/1 Mode	Dual-channel
Safety Output 1	Safety Output 1 Channel Mode	Safety

Interlock String

This example shows wiring and controller configuration when using a Guard I/O module with an interlock string. If used in combination with the programs in a safety controller, this wiring is Safety Category 4 in accordance with EN 954-1 wiring requirements.

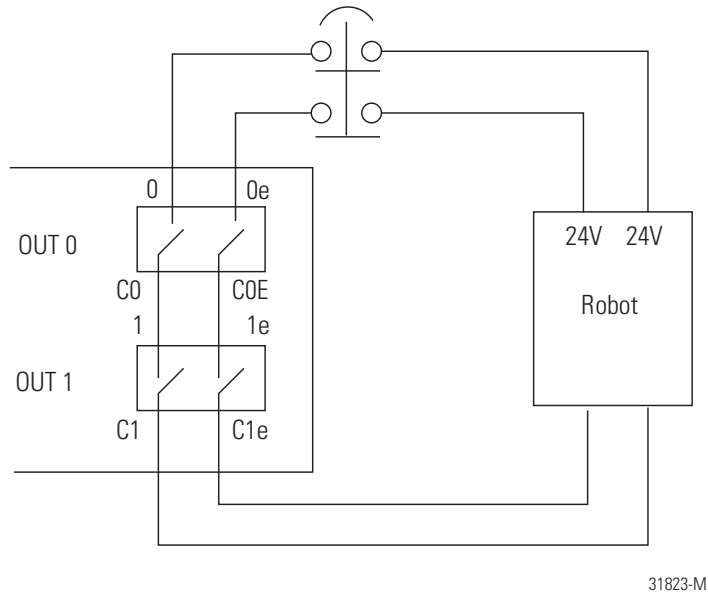

Test Output Examples

Read this section for test output examples by application. For details, refer to the installation instructions for each catalog number.

Standard Inputs and Outputs

This example shows wiring and controller configuration when using a Guard I/O module with standard inputs and outputs.

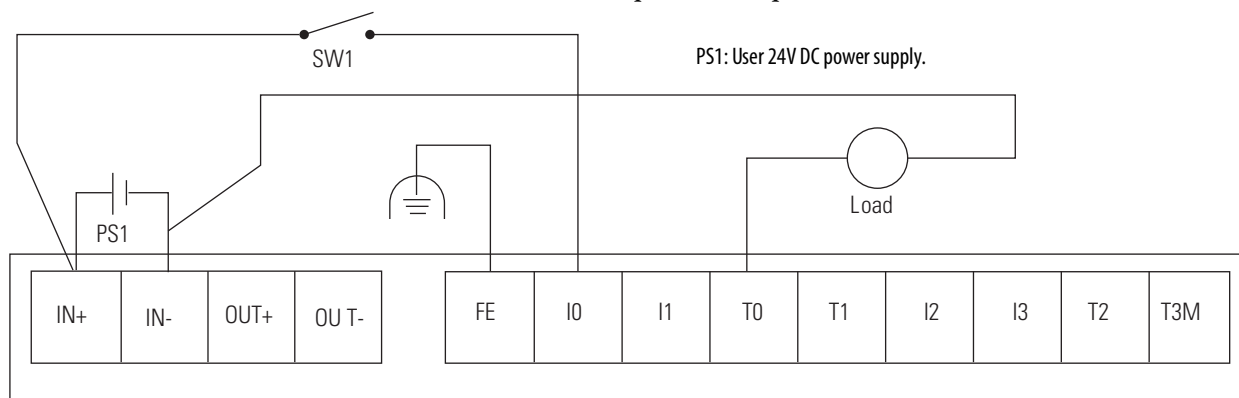

31809-M

Controller Configuration	Parameter Name	Configuration Setting
Safety Input 1	Safety Input 1 Channel Mode	Standard Input
	Safety Input 1 Test Source	None
	Dual-channel Safety Input 0/1 Mode	Single Channel
Test Pulse 0	Test Output 0 Mode 1	Standard Output

Muting Lamp Output

This example shows wiring and controller configuration when using a Guard I/O module with a muting lamp output.

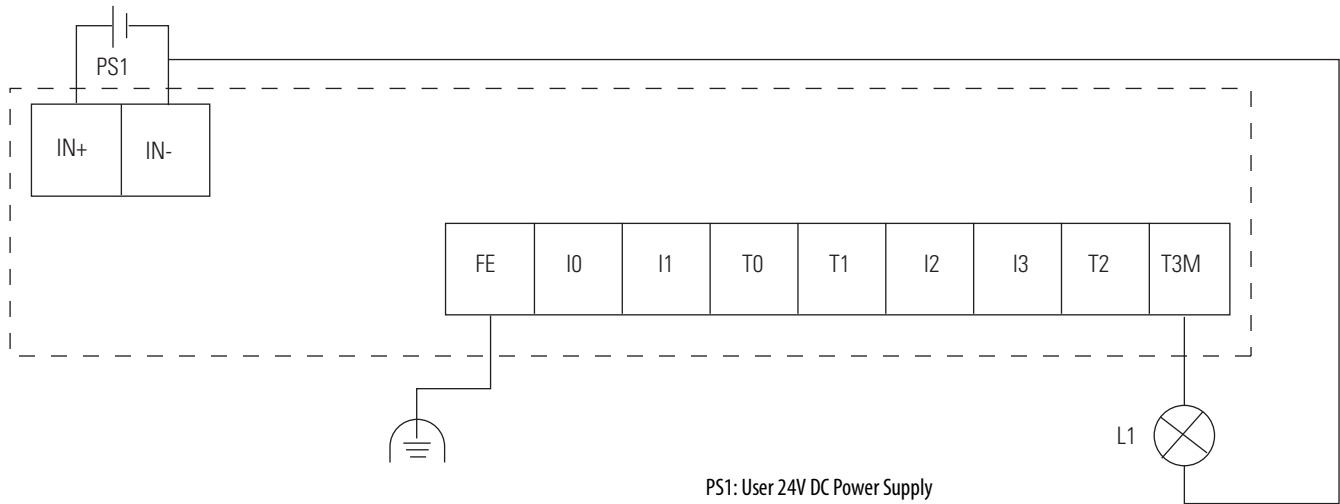

PS1: User 24V DC Power Supply

31810-M

Controller Configuration	Parameter Name	Configuration Setting
Test Output 3	Test Output 3 Mode	Muting Lamp Output

Configure Modules with the Logix Designer Application

Topic	Page
Use the Help Button	61
Add Modules to the I/O Configuration Tree	62
Set Up the Module Definition	64
Configure the Safety Tab	71
Configure the Input Configuration Tab	74
Configure the Test Output Tab	76
Configure the Output Configuration Tab	77
Save and Download Module Configuration	79

Use the Help Button

At the bottom of a dialog box, click Help for information about how to complete entries in the dialog box. At the bottom of a warning dialog box, click Help to get information about that specific error.

Add Modules to the I/O Configuration Tree

To add a module to the I/O configuration tree, follow these guidelines.

1. From the I/O Configuration tree, right-click the 1756-DNB module and choose New Module.

The Select Module dialog box appears with a list that includes Safety.

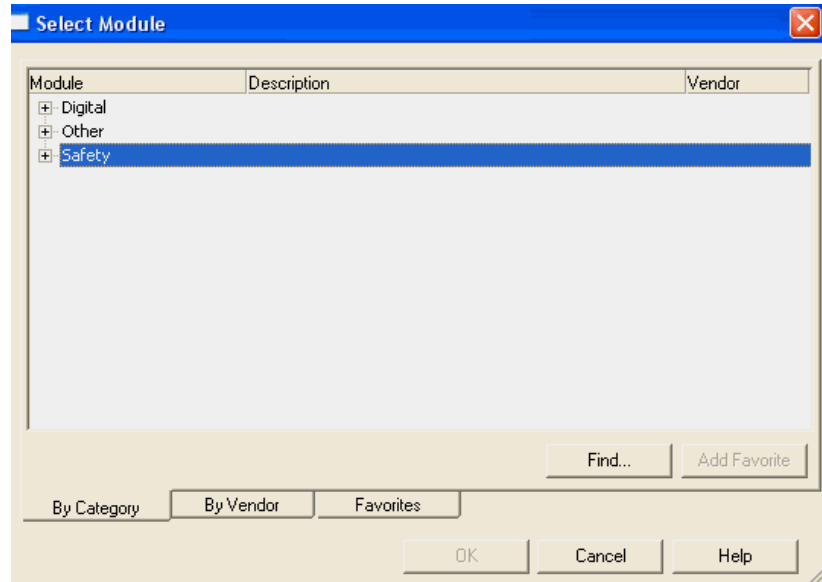

2. Expand the Safety category, select the appropriate module, and click OK.

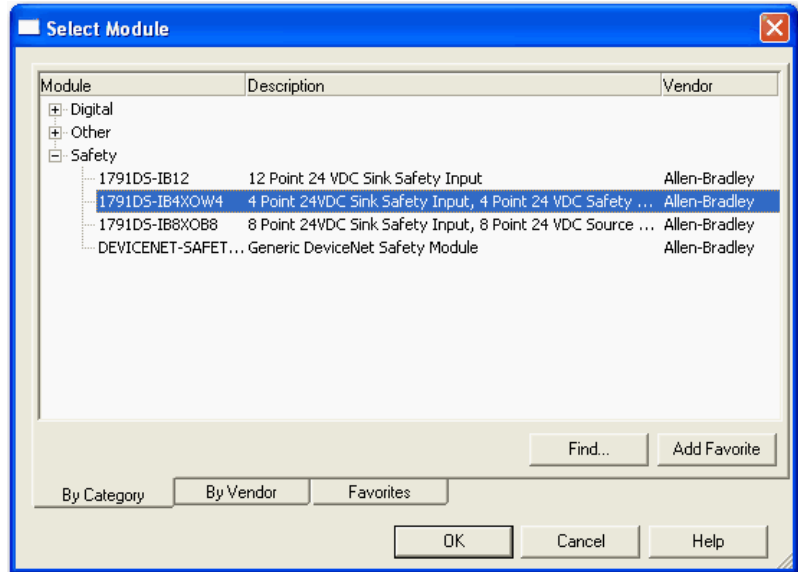

3. From the Module Properties dialog box, complete entries for the General dialog box.

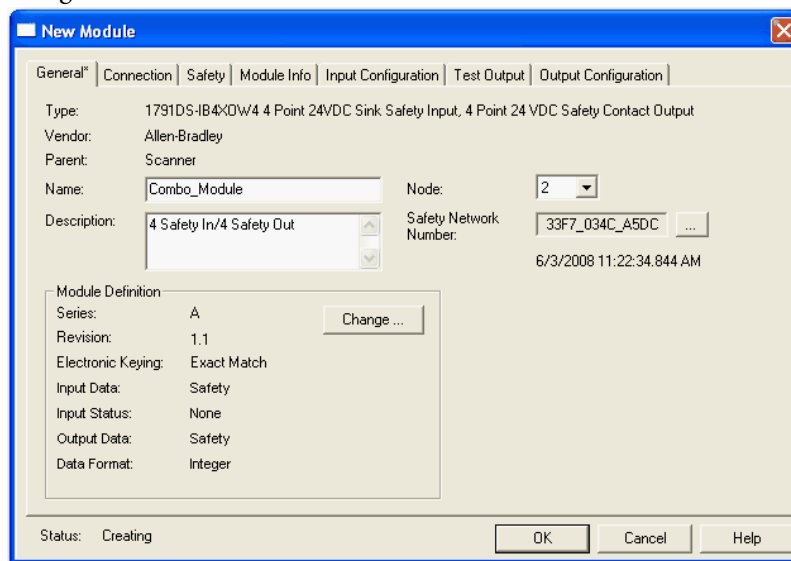

- a. For Name, type a unique name.
- b. For Node, choose the DeviceNet Node number, noting this number and the switches on the actual modules must match.
- c. For Description, if desired, type a description.
- d. For Safety Network Number, use the default setting.

For a detailed explanation of the safety network number (SNN), see the GuardLogix Controller Systems Safety Reference Manuals listed in the Additional Resources on [page 10](#).

The purpose of the Safety Network Number (SNN) is to make sure that every module in a system can be uniquely identified.

For example, assume there are two identical GuardLogix control systems—System A and System B—that are connected to a common Ethernet network. System A and System B have three DeviceNet networks with assorted standard and safety I/O modules. In systems like this, modules can have the same node number, but if each DeviceNet network has a unique SNN, each node will **not** have the same SNN and node number combination.

Another example of the usage of SNNs is when 1756-DNB modules are in the same chassis and the DeviceNet cables are inadvertently disconnected. If the cables are reattached incorrectly, the connection in the safety modules are broken because each 1756-DNB module is now connected to devices with different SNNs.

We suggest that all safety modules on a network have the same SNN, to make documentation easier. During configuration, the Logix Designer application defaults a safety device's SNN to match the SNN of the lowest safety node on the network.

Set Up the Module Definition

Follow these steps to edit the module definition. [Refer to Values and States of Tags on page 70.](#)

1. From the Module Properties dialog box, click Change.

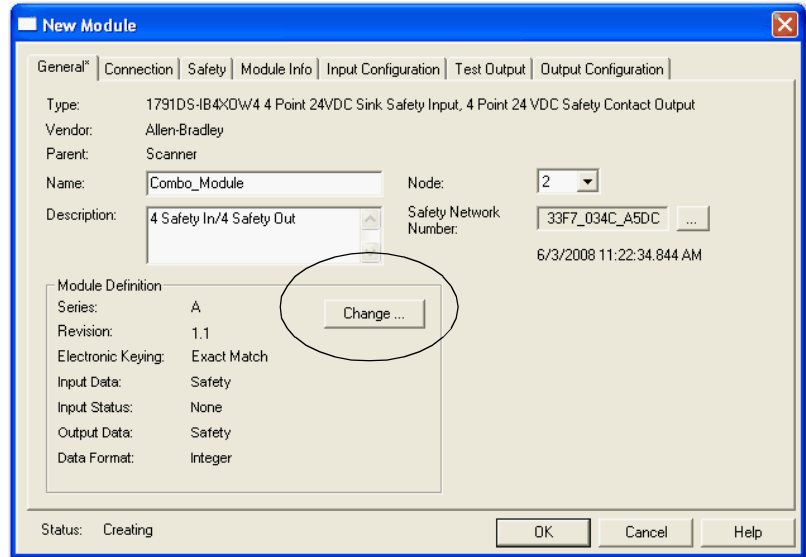

This dialog box appears.

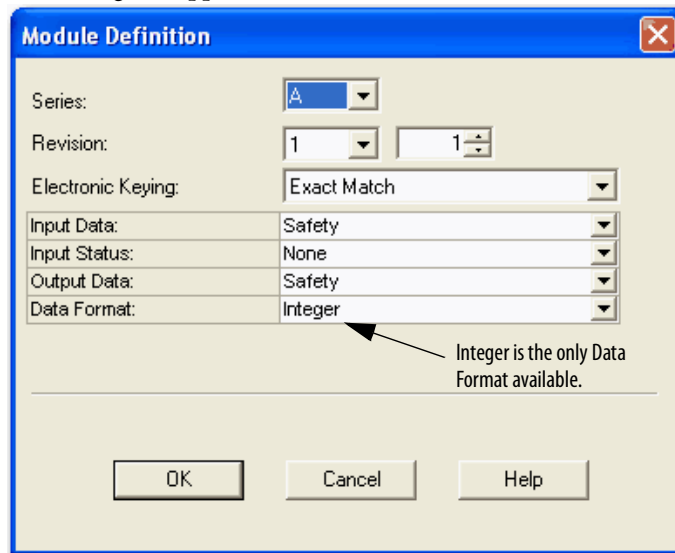

2. From the Series pull-down menu, choose your module's series level.
3. From the Revision pull-down menu, choose your module's revision level.
4. Assign the electronic keying.

Choose	Description
Exact Match	All of the parameters must match or the inserted module rejects a connection to the controller.
Compatible Module	Allows an I/O module to determine whether it can emulate the module defined in the configuration sent from the controller.

5. Assign the input data.

Choose	Description
Safety	These tags are created for the target module: <ul style="list-style-type: none"> -RunMode for module mode -ConnectionFaulted for communication status -Safety Data for safety inputs from the module

IB8×OB8:I	{...}	{...}		AB:1791D...	Safety
IB8×OB8:I.RunMode	0		Decimal	BOOL	Safety
IB8×OB8:I.ConnectionFaulted	0		Decimal	BOOL	Safety
IB8×OB8:I.Pt00Data	0		Decimal	BOOL	Safety
IB8×OB8:I.Pt01Data	0		Decimal	BOOL	Safety
IB8×OB8:I.Pt02Data	0		Decimal	BOOL	Safety
IB8×OB8:I.Pt03Data	0		Decimal	BOOL	Safety
IB8×OB8:I.Pt04Data	0		Decimal	BOOL	Safety
IB8×OB8:I.Pt05Data	0		Decimal	BOOL	Safety
IB8×OB8:I.Pt06Data	0		Decimal	BOOL	Safety
IB8×OB8:I.Pt07Data	0		Decimal	BOOL	Safety

Choose	Description
Safety-Readback	This option creates safety and readback tags, with readback indicating the presence of 24V on the output terminal. Safety-Readback is not available for input-only safety modules.

-IB8xOB8:1.Pt00Readback	0	Decimal	BOOL	Safety
-IB8xOB8:1.Pt01Readback	0	Decimal	BOOL	Safety
-IB8xOB8:1.Pt02Readback	0	Decimal	BOOL	Safety
-IB8xOB8:1.Pt03Readback	0	Decimal	BOOL	Safety
-IB8xOB8:1.Pt04Readback	0	Decimal	BOOL	Safety
-IB8xOB8:1.Pt05Readback	0	Decimal	BOOL	Safety
-IB8xOB8:1.Pt06Readback	0	Decimal	BOOL	Safety
-IB8xOB8:1.Pt07Readback	0	Decimal	BOOL	Safety

Small Safety (1791DS-IB12 module only)	This option is for 12-point safety input modules that use 8 or fewer safety inputs. The Small Safety option reduces the amount of data that the 12-point module sends to the controller to improve network performance. Safety data and point status tags are created. Point status is diagnostic status for each of the eight input points.
--	--

-IB12:1.RunMode	0	Decimal	BOOL	Safety
-IB12:1.ConnectionFaulted	0	Decimal	BOOL	Safety
-IB12:1.Pt00Data	0	Decimal	BOOL	Safety
-IB12:1.Pt01Data	0	Decimal	BOOL	Safety
-IB12:1.Pt02Data	0	Decimal	BOOL	Safety
-IB12:1.Pt03Data	0	Decimal	BOOL	Safety
-IB12:1.Pt04Data	0	Decimal	BOOL	Safety
-IB12:1.Pt05Data	0	Decimal	BOOL	Safety
-IB12:1.Pt06Data	0	Decimal	BOOL	Safety
-IB12:1.Pt07Data	0	Decimal	BOOL	Safety
-IB12:1.Pt08Data	0	Decimal	BOOL	Safety
-IB12:1.Pt09Data	0	Decimal	BOOL	Safety
-IB12:1.Pt10Data	0	Decimal	BOOL	Safety
-IB12:1.Pt11Data	0	Decimal	BOOL	Safety
-IB12:1.Pt00Status	0	Decimal	BOOL	Safety
-IB12:1.Pt01Status	0	Decimal	BOOL	Safety
-IB12:1.Pt02Status	0	Decimal	BOOL	Safety
-IB12:1.Pt03Status	0	Decimal	BOOL	Safety
-IB12:1.Pt04Status	0	Decimal	BOOL	Safety
-IB12:1.Pt05Status	0	Decimal	BOOL	Safety
-IB12:1.Pt06Status	0	Decimal	BOOL	Safety
-IB12:1.Pt07Status	0	Decimal	BOOL	Safety

6. Assign the input status.

Choose	Description
None	There are no status tags, only data for the inputs.
Pt. Status	There is one status tag for each input and output point.

IB8×DB8:I.Pt00InputStatus	0	Decimal	BOOL	Safety
IB8×DB8:I.Pt01InputStatus	0	Decimal	BOOL	Safety
IB8×DB8:I.Pt02InputStatus	0	Decimal	BOOL	Safety
IB8×DB8:I.Pt03InputStatus	0	Decimal	BOOL	Safety
IB8×DB8:I.Pt04InputStatus	0	Decimal	BOOL	Safety
IB8×DB8:I.Pt05InputStatus	0	Decimal	BOOL	Safety
IB8×DB8:I.Pt06InputStatus	0	Decimal	BOOL	Safety
IB8×DB8:I.Pt07InputStatus	0	Decimal	BOOL	Safety
IB8×DB8:I.Pt00OutputStatus	0	Decimal	BOOL	Safety
IB8×DB8:I.Pt01OutputStatus	0	Decimal	BOOL	Safety
IB8×DB8:I.Pt02OutputStatus	0	Decimal	BOOL	Safety
IB8×DB8:I.Pt03OutputStatus	0	Decimal	BOOL	Safety
IB8×DB8:I.Pt04OutputStatus	0	Decimal	BOOL	Safety
IB8×DB8:I.Pt05OutputStatus	0	Decimal	BOOL	Safety
IB8×DB8:I.Pt06OutputStatus	0	Decimal	BOOL	Safety

Pt. Status - Muting

There is a muting status tag for test output T3, T7, T11, and T15 with point status for each input and output point.

IB8×DB8:I.Pt00InputStatus	0	Decimal	BOOL	Safety
IB8×DB8:I.Pt01InputStatus	0	Decimal	BOOL	Safety
IB8×DB8:I.Pt02InputStatus	0	Decimal	BOOL	Safety
IB8×DB8:I.Pt03InputStatus	0	Decimal	BOOL	Safety
IB8×DB8:I.Pt04InputStatus	0	Decimal	BOOL	Safety
IB8×DB8:I.Pt05InputStatus	0	Decimal	BOOL	Safety
IB8×DB8:I.Pt06InputStatus	0	Decimal	BOOL	Safety
IB8×DB8:I.Pt07InputStatus	0	Decimal	BOOL	Safety
IB8×DB8:I.Pt00OutputStatus	0	Decimal	BOOL	Safety
IB8×DB8:I.Pt01OutputStatus	0	Decimal	BOOL	Safety
IB8×DB8:I.Pt02OutputStatus	0	Decimal	BOOL	Safety
IB8×DB8:I.Pt03OutputStatus	0	Decimal	BOOL	Safety
IB8×DB8:I.Pt04OutputStatus	0	Decimal	BOOL	Safety
IB8×DB8:I.Pt05OutputStatus	0	Decimal	BOOL	Safety
IB8×DB8:I.Pt06OutputStatus	0	Decimal	BOOL	Safety
IB8×DB8:I.Pt07OutputStatus	0	Decimal	BOOL	Safety
IB8×DB8:I.MutingStatus	0	Decimal	BOOL	Safety

Choose	Description
Combined Status - Muting	<ul style="list-style-type: none"> -A single BOOL tag represents an AND of the status bits for all the input points. For example, if any input channel has a fault, this bit goes LO.⁽¹⁾ -A single BOOL tag represents an AND of the status bits for all the output points. -A muting status tag for test output T3, T7, T11, and T15.

IB8×DB8:I.OutputStatus	0	Decimal	BOOL	Safety
IB8×DB8:I.InputStatus	0	Decimal	BOOL	Safety
IB8×DB8:I.MutingStatus	0	Decimal	BOOL	Safety

Choose	Description
Pt. Status-Muting-Test Output	<ul style="list-style-type: none"> -Status tags for each of the input and output points. -Muting status tag for test output T3, T7, T11, and T15. -Status tags for each of the test outputs.

Small_Safety:I.Pt00TestOutputStatus	0	Decimal	BOOL	Safety
Small_Safety:I.Pt01TestOutputStatus	0	Decimal	BOOL	Safety
Small_Safety:I.Pt02TestOutputStatus	0	Decimal	BOOL	Safety
Small_Safety:I.Pt03TestOutputStatus	0	Decimal	BOOL	Safety
Small_Safety:I.MutingStatus	0	Decimal	BOOL	Safety

(1) When using combined status, use explicit messaging to read individual point status for diagnostic purposes.

7. Assign the output data.

IMPORTANT The test outputs that are configured as standard outputs on the module must not be used for safety purposes.

Choose	Description
None	Results in an input only connection to the module. Inputs and status are read, but no outputs are written.
Safety	Creates these safety tags and enables these outputs for use in the safety task.

IB8×DB8:O.Pt00Data	0	Decimal	BOOL
IB8×DB8:O.Pt01Data	0	Decimal	BOOL
IB8×DB8:O.Pt02Data	0	Decimal	BOOL
IB8×DB8:O.Pt03Data	0	Decimal	BOOL
IB8×DB8:O.Pt04Data	0	Decimal	BOOL
IB8×DB8:O.Pt05Data	0	Decimal	BOOL
IB8×DB8:O.Pt06Data	0	Decimal	BOOL
IB8×DB8:O.Pt07Data	0	Decimal	BOOL

Choose	Description
Test	Creates these tags and enables the test outputs on the module. These outputs are standard outputs and must not be used for safety purposes.

IB8×OB8:O.Test00Data	0	Decimal	BOOL	Safety
IB8×OB8:O.Test01Data	0	Decimal	BOOL	Safety
IB8×OB8:O.Test02Data	0	Decimal	BOOL	Safety
IB8×OB8:O.Test03Data	0	Decimal	BOOL	Safety

Combined	Creates these tags and enables all modules outputs, safety and test.
----------	--

IB8×OB8:O.Pt00Data	0	Decimal	BOOL	Safety
IB8×OB8:O.Pt01Data	0	Decimal	BOOL	Safety
IB8×OB8:O.Pt02Data	0	Decimal	BOOL	Safety
IB8×OB8:O.Pt03Data	0	Decimal	BOOL	Safety
IB8×OB8:O.Pt04Data	0	Decimal	BOOL	Safety
IB8×OB8:O.Pt05Data	0	Decimal	BOOL	Safety
IB8×OB8:O.Pt06Data	0	Decimal	BOOL	Safety
IB8×OB8:O.Pt07Data	0	Decimal	BOOL	Safety
IB8×OB8:O.Test00Data	0	Decimal	BOOL	Safety
IB8×OB8:O.Test01Data	0	Decimal	BOOL	Safety
IB8×OB8:O.Test02Data	0	Decimal	BOOL	Safety
IB8×OB8:O.Test03Data	0	Decimal	BOOL	Safety

Values and States of Tags

Use this table to determine the values and states of the tags.

Data		Description
Input data	Safety Input Data SAFETY	Indicates the ON/OFF status of each input circuit. -ON: 1 OFF: 0
	Combined Safety Input Status SAFETY	An AND of the status of all input circuits. -All circuits are normal: 1 -An error was detected in one or more input circuits: 0
	Individual Safety Input Status SAFETY	Indicates the status of each input circuit. - Normal: 1 Fault (Alarm): 0
	Combined Safety Output Status SAFETY	An AND of the status of all safety output circuits. -All circuits are normal: 1 -An error has been detected in one or more output circuits: 0
	Individual Safety Output Status SAFETY	Indicates the status of each safety output circuit. -Normal: 1 Fault (Alarm): 0
	Muting Lamp Status SAFETY	Indicates the status when circuit T3, T7, T11, and T15 is configured as the muting lamp output. -Normal: 1 Fault (Alarm): 0
	Output Readback STANDARD	Monitors the presence of 24V on the output circuit. Readback is ON (1) if 24V is on output terminal. -ON: 1 OFF: 0
	Individual Test Output Status STANDARD	Indicates the status of each of the test output circuits. -Normal: 1 Fault (Alarm): 0
Output data	Safety Output Data SAFETY	Controls the safety output. -ON: 1 OFF: 0
	Standard Output Data STANDARD	Controls the test output when Test Output mode is set to a standard output. -ON: 1 OFF: 0

IMPORTANT

Safety denotes information the controller can use in safety-related functions. Standard denotes additional information that must not be relied on for safety functions.

Configure the Safety Tab

Read this for information about how to complete entries when you click the Safety tab.

1. From the Module Properties dialog box, click the Safety tab.

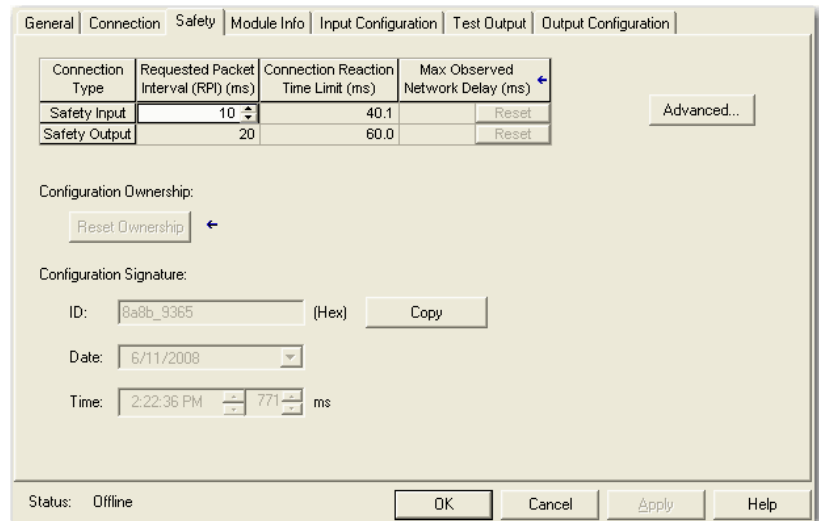

2. To configure the Requested Packet Interval (RPI), click Advanced.

You see the Advanced Connection Reaction Time Limit Configuration dialog box.

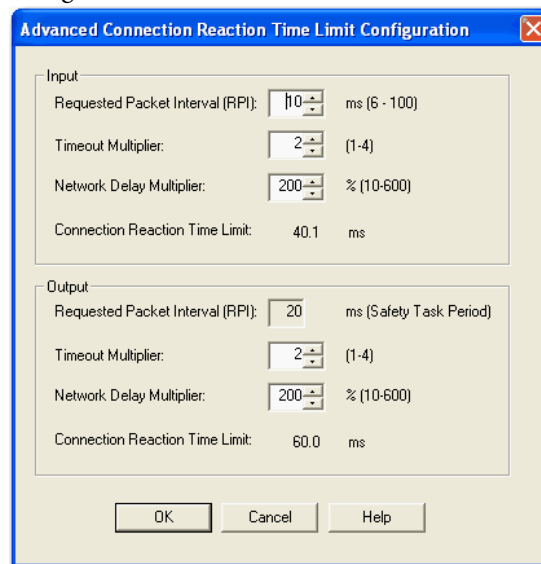

For more information about the Connection Reaction Time Limit, see the GuardLogix Controllers User Manual, publication [1756-UM020](#).

3. In the Requested Packet Interval (RPI) box, enter the input connection RPI to support your application (between 6 and 500 ms).

Selecting too small an RPI unnecessarily consumes network bandwidth; selecting too large an RPI increases safety reaction time. Selecting the appropriate RPI results in a system with optimized performance.

As an example, a safety input module with only ESTOP switches connected to it generally may work well with settings of 50...100 ms. An input module with a light curtain guarding a hazard may need the fastest response that is possible.

IMPORTANT Analyze each safety channel to determine what is appropriate. The default Time-out Multiplier of 2 and Network Delay Multiplier of 200 will create an input-connection reaction time limit of four times the RPI and an output-connection reaction time limit of three times the RPI. Changes to these parameters should be approved by a safety administrator.

TIP We recommend keeping the Time-out Multiplier and Network Delay Multiplier at their default values of 2 and 200.

A connection status tag exists for every connection.

IB8×DB8:I	{...}	{...}		AB:1791D...	Safety
IB8×DB8:I.RunMode	1		Decimal	BOOL	Safety
IB8×DB8:I.ConnectionFaulted	0		Decimal	BOOL	Safety
IB8×DB8:I.PtOOData	0		Decimal	BOOL	Safety

When the connection reaction time limit and requested packet interval are set appropriately, this status tag always remains LO. Monitor all connection status bits to verify that they are not going HI intermittently due to timeouts.

Configuration Ownership - Reset Ownership

The connection between the owner and the Guard I/O module is based on the following:

- Guard I/O DeviceNet node address
- Guard I/O safety network number
- GuardLogix slot number
- GuardLogix safety network number
- Path from GuardLogix controller to Guard I/O module
- Configuration signature

If any of these change, the connection between the GuardLogix controller and the Guard I/O module is lost, and the yellow yield in the project tree appears. Reset ownership to reestablish the connection by using this procedure.

1. From within the Logix Designer application, open the safety I/O module properties.
2. Click the Safety tab.
3. Click Reset Ownership.

Configuration Signature

The configuration signature is created by the Logix Designer application and verified by the safety module. The configuration signature provides SIL 3 integrity of the configuration of a Guard I/O module.

- When a GuardLogix controller first connects to an unconfigured Guard I/O module, the complete configuration is downloaded to the I/O module.
- Any time the GuardLogix controller attempts to connect to a Guard I/O module, if the configuration signatures are the same, then the configuration does not need to be downloaded, because they already match.
- Any time the GuardLogix controller attempts to connect to a Guard I/O module and the signatures do not match, the module checks the module node address, electronic keying, and safety network number. If these are all correct, the controller will attempt to configure the module.

Configure the Input Configuration Tab

Follow this procedure to complete the input configuration. Refer to [Chapter 2](#) for related information.

- From the Module Properties dialog box, click the Input Configuration tab.

Point	Point Operation		Point Mode	Test Source	Input Delay Time (ms)	
	Type	Discrepancy Time (ms)			Off->On	On->Off
0	Single	0	Not Used	None	0	0
1			Not Used	None	0	0
2	Single	0	Not Used	None	0	0
3			Not Used	None	0	0
4	Single	0	Not Used	None	0	0
5			Not Used	None	0	0
6	Single	0	Not Used	None	0	0
7			Not Used	None	0	0

Input Error Latch Time: 1000 ms

Status: Offline OK Cancel Apply Help

- Assign the Point Operation Type.

When you choose Equivalent or Complementary, you must also assign an appropriate Discrepancy Time.

Choose	Description
Single	Inputs are treated as single channels. Note that in many cases, dual-channel safety inputs are configured as two individual single channels. This does not affect pulse testing because it is handled on an individual channel basis.
Equivalent ⁽¹⁾	Inputs are treated as a dual-channel pair. The channels must match within the discrepancy time or an error is generated.
Complementary ⁽¹⁾	Input are treated as a dual-channel pair. They must be in opposite states within the discrepancy time or an error is generated.

(1) Be aware that configuring discrepancy time on safety I/O modules masks input discrepancies detected by the controller safety instructions. Status can be read by the controller to obtain this fault information.

A discrepancy time setting of 0 ms means that the channels in a dual configuration can be discrepant for an infinite amount of time without a fault being declared.

For a discrepancy time setting of 0 ms, the evaluated status of the inputs still go to the Safe State in the event of a 'cycle inputs' required condition, but due to the 0 ms discrepancy time, a fault will not be declared.

A 'cycle inputs' required condition occurs when one input terminal goes from its normal Active>Inactive>Active state while the other input terminal remains in its normal Active state. Even though no fault is declared, the inputs must be cycled before the evaluated status of the inputs can return to the Active state.

3. Assign the Point Mode.

Choose	Description
Not Used	The input is disabled. It remains logic 0 if 24V is applied to the input terminal.
Safety Pulse Test	Pulse testing is performed on this input circuit. A test source on the Guard I/O module must be used as the 24V source for this circuit. The test source is configured by using the test source pull-down menu. The pulse test will detect shorts to 24V and channel-to-channel shorts to other inputs.
Safety	A safety input is connected but there is no requirement for the Guard I/O module to perform a pulse test on this circuit. An example is a safety device that performs its own pulse tests on the input wires, such as a light curtain.
Standard	A standard device, such as a reset switch, is connected. This point cannot be used in dual-channel operation.

4. Assign the Test Source for each safety input on the module you want pulse tested.

Choose	Description
None	If pulse testing is being performed on an input point, then the test source that is sourcing the 24V for the input circuit must be selected. If the incorrect test source is entered, the result is pulse test failures on that input circuit.
Test Output 0	
Test Output 1	
Test Output 2	
Test Output 3	
Test Output 4...15 ⁽¹⁾	

(1) The number of test outputs varies per catalog number.

5. Assign the Input Delay Time, Off -> On (0...126 ms, in increments of 6 ms).

Filter time is for OFF to ON transition. Input must be HI after input delay has elapsed before it is set logic 1. This delay time is configured per channel with each channel specifically tuned to match the characteristics of the field device, for maximum performance.

6. Assign the Input Delay Time, Off -> On (0...126 ms, in increments of 6 ms).

Filter time is ON to OFF transition. Input must be LO after input delay has elapsed before it is set logic 0. This delay time is configured per channel with each channel specifically tuned to match the characteristics of the field device, for maximum performance.

7. From the Input Error Latch Time box, enter the time the module holds an error to make sure the controller can detect it (0...65,530 ms, in increments of 10 ms - default 1000 ms).

This provides you more reliable diagnostics and enhances the chances that a nuisance error is detected. The purpose for latching input errors is to make sure that intermittent faults that may only exist for a few milliseconds are latched long enough to be read by the controller. The amount of time to latch the errors should be based on the RPI, the safety task watchdog, and other application-specific variables.

8. Click OK.

Configure the Test Output Tab

This section describes how to work with the Test Output Configuration dialog box. Refer to this table for information on configuring test outputs.

Follow this procedure to complete the test output configuration.

1. From the Module Properties dialog box, click the Test Output tab.

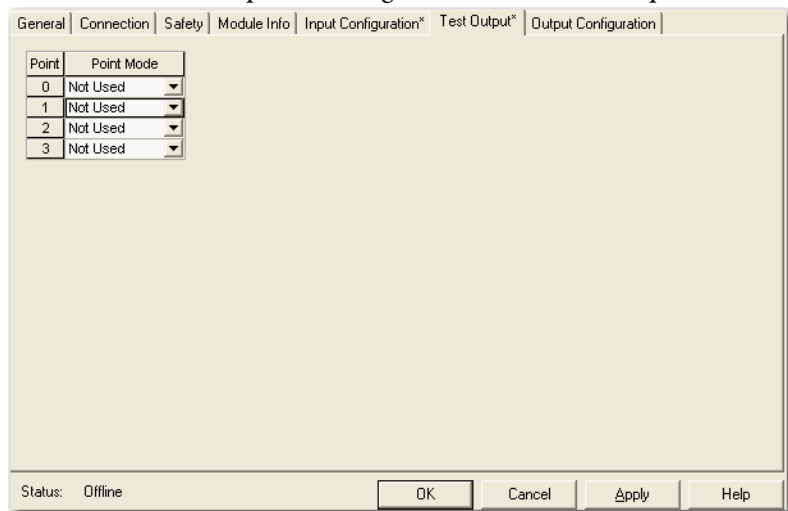

2. Assign the Point Mode⁽¹⁾.

Choose	Description
Not Used (default)	The standard output is disabled.
Standard	The output point is enabled for use by the GuardLogix controller.
Pulse Test	The test output is being used as a pulse test source.
Power Supply	A constant 24V is placed on the output terminal. It can be used to provide power to a field device.
Muting Lamp Output (terminal T3, T7, T11, and T15 only)	An indicator lamp is connected to the output. When this lamp is energized, a burned-out bulb, broken wire, or short to GND error condition can be detected. Typically, the lamp is an indicator used in light curtain applications.

There is also a Test Output Fault Action parameter that can only be read or written to via explicit messaging. If communication to the module times out, you can set the test outputs to Clear OFF (default) or Hold Last State.

3. Click OK.

Configure the Output Configuration Tab

This section provides a procedure for configuring safety outputs by using the information in this table and completing the entries referring to the figure.

Follow this procedure to complete the safety output configuration.

1. From the Module Properties dialog box, click the Output Configuration tab.

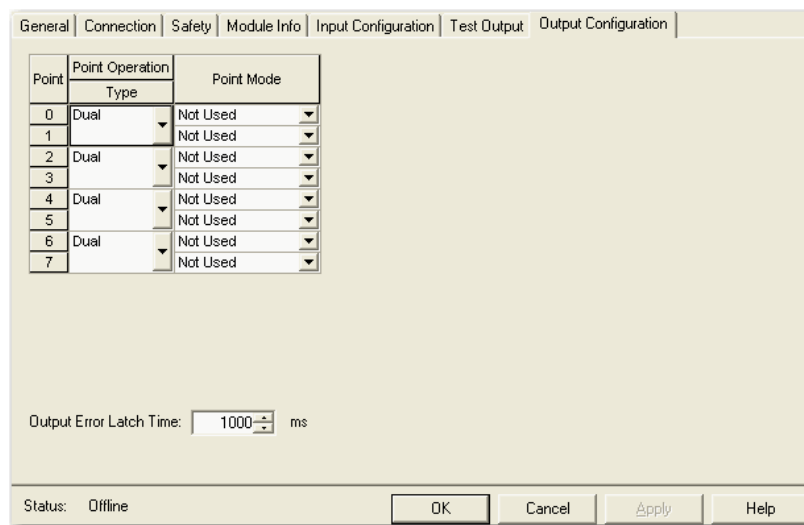

2. Assign the Point Operation Type.

Choose	Description
Single ⁽¹⁾	The output is treated as a single channel.
Dual (default)	The Guard I/O module treats the outputs as a pair. It always sets them HI or LO as a matched pair. Safety logic must set both of these outputs ON or OFF as the same time or the module declares a channel fault.

(1) Does not apply to bipolar outputs.

(1) Directly related to safety.

3. Assign the Point Mode.

Choose	Description
Not Used (default)	The output is disabled.
Safety	The output point is enabled, and it does not perform a pulse test on the output.
Safety Pulse Test	The output point is enabled and performs a pulse test on the output. When the output is energized, the output pulses LO briefly. The pulse test detects if 24V remains on the output terminal during this LO pulse due to a short to 24V or if the output is shorted to another output terminal.

4. From the Output Error Latch Time box, enter the time the module holds an error to make sure the controller can detect it (0...65,530 ms, in increments of 10 ms - default 1000 ms).

This provides you more reliable diagnostics and enhances the changes that a nuisance error is detected.

The purpose for latching output errors is to make sure that intermittent faults that may only exist for a few milliseconds are latched long enough to be read by the controller. The amount of time to latch the errors will be based on the RPI, the safety task watchdog, and other application-specific variables.

5. Click OK.

Save and Download Module Configuration

We recommend that after a module is configured you save your work.

If after downloading the program the MS and NS status indicators on the Guard I/O module are not both solid green, this may be due to loss of ownership. The ownership is based on the following:

- Guard I/O DeviceNet node number
- Guard I/O safety network number
- GuardLogix slot number
- GuardLogix safety network number
- Path from GuardLogix controller to Guard I/O module
- Configuration signature

If any of these change, the connection between the GuardLogix controller and the Guard I/O module is lost, and the yellow yield in the project tree appears. Reset ownership to reestablish the connection using this procedure.

1. From the Module Properties dialog box, click the Safety tab.

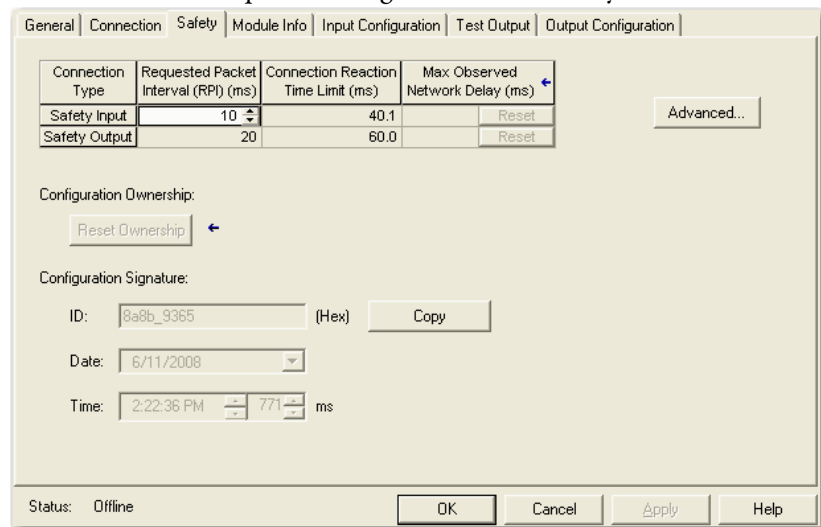

2. Click Reset Ownership.
3. Click OK.

Notes:

Configure Modules in RSNetWorx for DeviceNet Software

Topic	Page
Before You Begin	81
Add Modules to the I/O Configuration	82
Configure the I/O Module	86
Save and Download the Module Configuration	92
Set Up the 1791DS I/O Module Definition	93
Troubleshooting	109

This chapter provides information about how to configure Guard I/O modules by using RSNetWorx for DeviceNet software and a SmartGuard controller. Refer to the corresponding software help files for network-configurator operating procedures.

This chapter covers how to configure a SmartGuard controller and Guard I/O module by using Universal Serial Bus (USB) connectivity.

Before You Begin

Be sure you have these required items:

- RSNetWorx for DeviceNet software, version 8.0 or later
- RSLinx software, version 2.51 or later
- SmartGuard USB driver

The SmartGuard USB driver should already be in your RSLinx software. If it is not, load the driver onto your computer, noting the folder location as you need to browse to it later.

- Personal computer with a Microsoft Windows 2000, Microsoft Windows 2000 Terminal Server, or Microsoft Windows XP operating system

Add Modules to the I/O Configuration

Follow these steps to add modules to the I/O configuration.

1. In RSNetWorx for DeviceNet software, drag the appropriate hardware onto the window to match your physical layout.

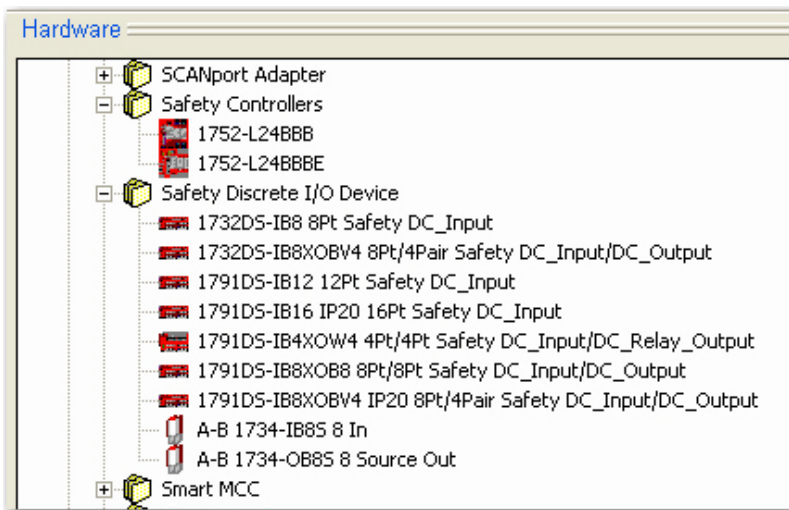

The devices have default names and node numbers when created.

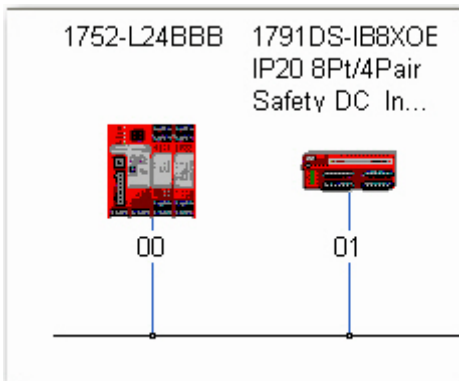

2. Right-click a device and choose Properties.

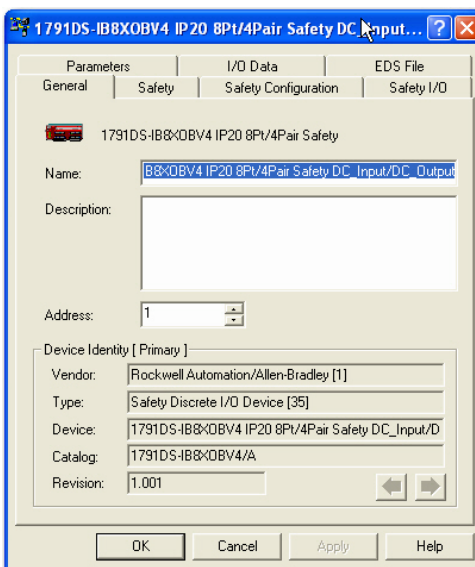

3. From the General tab, change these values.
 - a. In the Name box, type a unique name.
 - b. In the Description box, type a description (optional).
 - c. In the Address box, enter the DeviceNet node number.

This DeviceNet node number and the switches on the actual module **must** match.

4. Click the Safety tab.

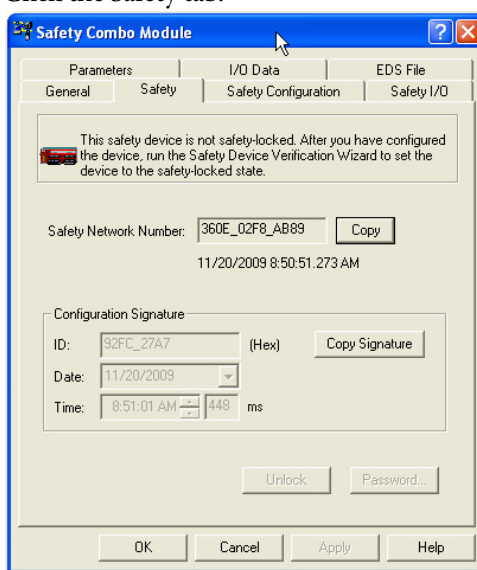

On the Safety tab, you set the safety network number (SNN) and the configuration signature.

Safety Network Number (SNN)

The purpose of the safety network number (SNN) is to make sure that every module in a system can be uniquely identified.

For example, assume there are two identical GuardLogix control systems—System A and System B—that are connected to a common Ethernet network. System A and System B have three DeviceNet networks with assorted standard and safety I/O modules. In systems like this, modules can have the same node number, but if each DeviceNet network has a unique SNN, each node will **not** have the same SNN and node number combination.

Another example of the usage of SNNs is when 1756-DNB modules are in the same chassis and the DeviceNet cables are inadvertently disconnected. If the cables are reattached incorrectly, the connection in the safety modules are broken because each 1756-DNB module is now connected to devices with different SNNs.

We suggest that all safety modules on a network have the same SNN, to make documentation easier. During configuration, the Logix Designer application

software defaults a safety device's SNN to match the SNN of the lowest safety node on the network.

The safety connection between a controller and I/O module is based on many items, one of which is the SNN of both devices. They do **not** have to match for a safety connection to be established, but the connection will be broken if the SNN of either device changes.

The safety network defaults to match the SNN of the lowest node on the network. If your safety controller is the lowest node on the network, then all of the safety I/O modules on the network will have the same SNN as the controller. As this is the recommended method of configuring the SNN, you may not need to do anything more with the SNN.

For a detailed explanation of the SNN, see the GuardLogix Controller Systems Safety Reference Manuals listed in the Additional Resources on [page 10](#).

Configuration Signature

The configuration signature is generated by the safety module each time the configuration is changed. It consists of an ID of the module configuration and the time and date the module configuration was created or changed. The configuration signature provides SIL 3 integrity of the configuration of a Guard I/O module.

The safety connection between a controller and I/O module is based on many items, one of which can be the configuration signature of the safety I/O module. If the configuration signature must match, the configuration signature must remain the same once the safety connection is established or the connection will be broken.

Figure 24 - Safety Connection and Configuration Signature

SmartGuard Safety Controller's Safety Connection Tab

When configured as shown below, the I/O module configuration signature must match the offline signature for a connection to be established.

Safety Module's Configuration Signature

Note that the configuration signature of the safety module matches that of the SmartGuard controller, so the safety

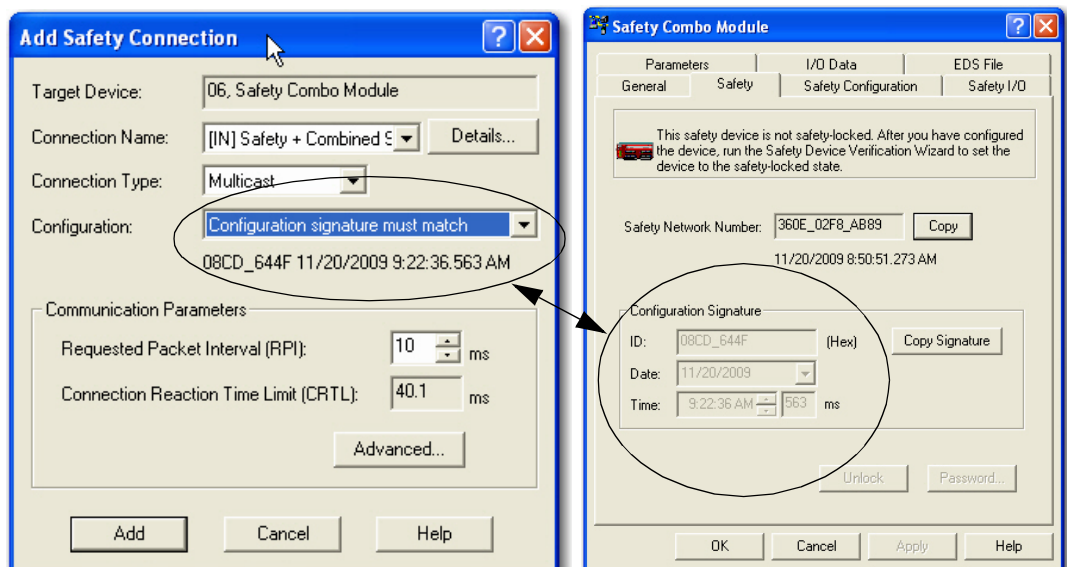

Configure the I/O Module

The following sections use the Safety Configuration tab. Input and output points change based on the type of module that you configure.

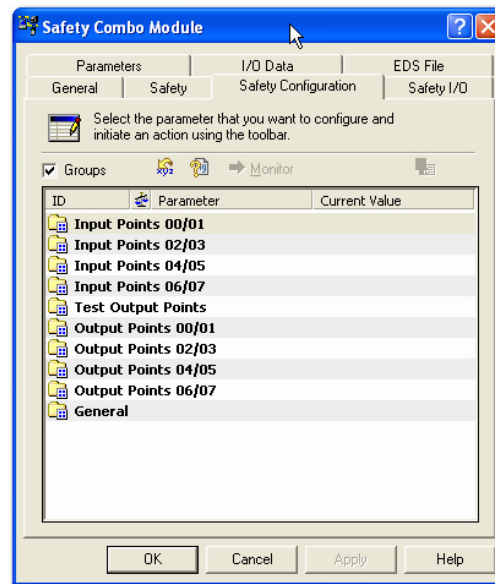

Configure the Input Channel

Follow these steps to configure the input channel.

1. Double-click Input Points *xx/xx*.

The Input Points folder expands. In this example, 00/01 is shown.

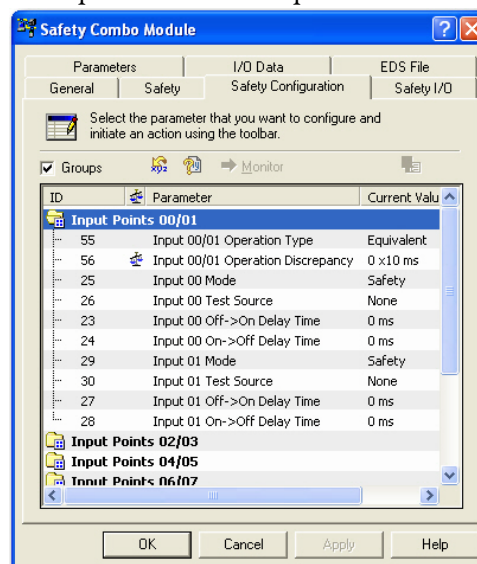

2. Assign the Operation Type.

When you choose Equivalent or Complementary, you must also assign an appropriate operation discrepancy time.

Choose	Description
Single	Inputs are treated as single channels. In many cases, dual-channel safety inputs are configured as two individual, single channels. This does not affect pulse testing because it is handled on an individual basis.
Equivalent ⁽¹⁾	Inputs are treated as a dual-channel pair. The channels must match within the discrepancy time or an error is generated.
Complementary ⁽¹⁾	Inputs are treated as a dual-channel pair. They must be in opposite states within the discrepancy time or an error is generated.

(1) Be aware that configuring discrepancy time on safety I/O modules masks input discrepancies detected by the controller safety instructions. Status can be read by the controller to obtain this fault information.

A discrepancy time setting of 0 ms means that the channels in a dual configuration can be discrepant for an infinite amount of time without a fault being declared.

For a discrepancy time setting of 0 ms, the evaluated status of the inputs still go to the safe state in the event of a 'cycle inputs' required condition. But, due to the 0 ms discrepancy time, a fault will not be declared.

A 'cycle inputs' required condition occurs when one input terminal goes from its normal active>inactive>active state while the other input terminal remains in its normal active state. Even though no fault is declared, the inputs must be cycles before the evaluated status of the inputs can return to the active state.

3. Assign the Mode.

Choose	Description
Not Used	The input is disabled. It remains logic 0 if 24V is applied to the input terminal.
Safety Pulse Test	Pulse testing is performed on this input circuit. A test source on the Guard I/O module must be used as the 24V source for this circuit. The test source is configured by using the test source pull-down menu. The pulse test will detect shorts to 24V and channel-to-channel shorts to other inputs.
Safety	A safety input is connected but there is no requirement for the Guard I/O module to perform a pulse test on this circuit. An example is a safety device that performs its own pulse tests on the input wires, such as a light curtain.
Standard	A standard device, such as a reset switch, is connected. This point cannot be used in dual-channel operation.

4. Assign the Test Source for each safety input on the module you want pulse tested.

Choose	Description
None	If pulse testing is being performed on an input point, then the test source that is sourcing the 24V for the input circuit must be selected. If the incorrect test source is entered, the result is pulse test failures on that input circuit.
0	
1	
2	
3	
4...15 ⁽¹⁾	

(1) The number of test outputs varies per catalog number.

5. Assign the Input Delay Time, Off -> On (0...126 ms, in increments of 6 ms).

Filter time is for OFF to ON transition. Input must be HI after input delay has elapsed before it is set logic 1. This delay time is configured per channel with each channel specifically tuned to match the characteristics of the field device, for maximum performance.

- Assign the Input Delay Time, Off -> On (0...126 ms, in increments of 6 ms).

Filter time is ON to OFF transition. Input must be LO after input delay has elapsed before it is set logic 0. This delay time is configured per channel with each channel specifically tuned to match the characteristics of the field device, for maximum performance.

Configure the Test Output

Follow these steps to configure the test outputs.

- Double-click Test Output Points.

The Test Output Points folder expands.

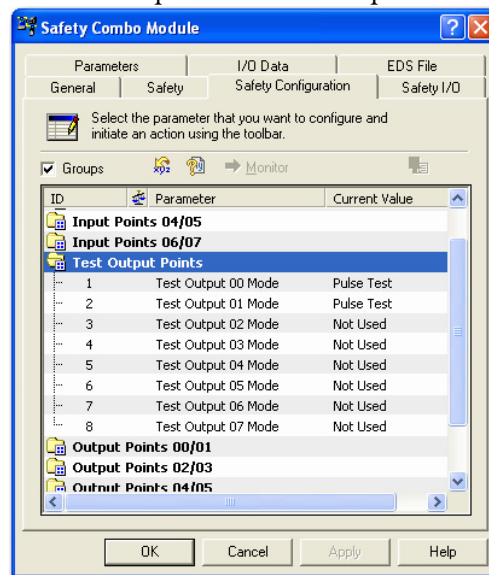

- Assign the Test Output Mode.

Choose	Description
Not Used (default)	The standard output is disabled.
Standard	The output point is enabled for use by the GuardLogix controller.
Pulse Test	The test output is being used as a pulse test source.
Power Supply	A constant 24V is placed on the output terminal. It can be used to provide power to a field device.
Muting Lamp Output (terminal T3, T7, T11, and T15 only)	An indicator lamp is connected to the output. When this lamp is energized, a burned-out bulb, broken wire, or short to GND error condition can be detected. Typically, the lamp is an indicator used in light curtain applications.

There is also a Test Output Fault Action parameter that can only be read or written to via explicit messaging. If communication to the module times out, you can set the test outputs to Clear OFF (default) or Hold Last State.

Configure the Output Channel

Follow these steps to configure the safety output channel.

1. Double-click Output Points *xx/xx*.

The Output Points folder expands. In this example, 00/01 is shown.

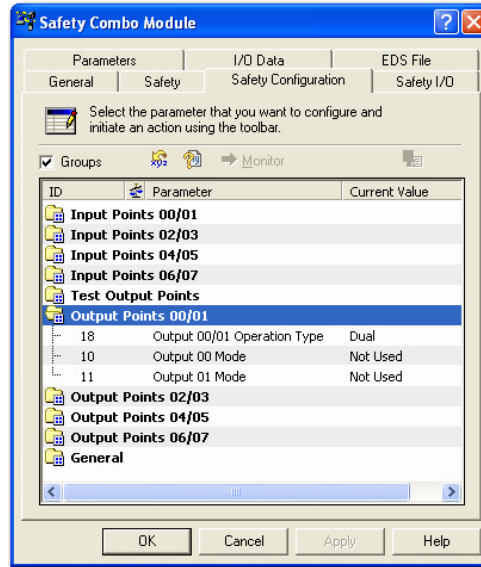

2. Assign the Operation Type.

Choose	Description
Single ⁽¹⁾	The output is treated as a single channel.
Dual (default)	The Guard I/O module treats the outputs as a pair. It always sets them HI or LO as a matched pair. Safety logic must set both of these outputs ON or OFF as the same time or the module declares a channel fault.

(1) Does not apply to bipolar outputs.

3. Assign the channel Mode.

Choose	Description
Not Used (default)	The output is disabled.
Safety	The output point is enabled, and it does not perform a pulse test on the output.
Safety Pulse Test	The output point is enabled and performs a pulse test on the output. When the output is energized, the output pulses LO briefly. The pulse test detects if 24V remains on the output terminal during this LO pulse due to a short to 24V or if the output is shorted to another output terminal.

Configure Input and Output Error Latch Times

Follow these steps to configure the input and output error latch times.

1. Double-click General.

The General folder expands.

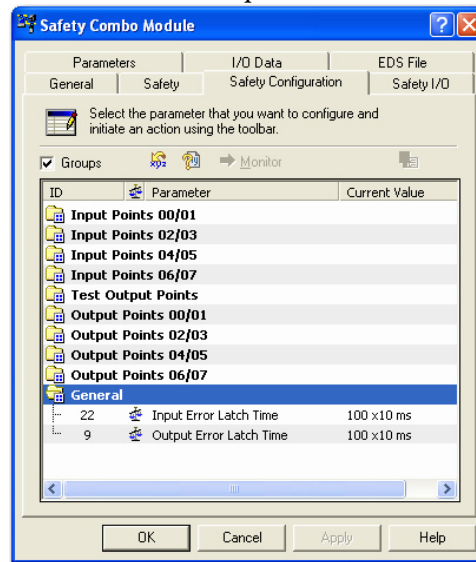

2. Enter the Input Error Latch Time, the time the module holds an error to make sure the controller can detect it (0...65,530 ms, in increments of 10 ms—default 1000 ms).

This provides you more reliable diagnostics and enhances the changes that a nuisance error is detected. The purpose for latching input errors is to make sure that intermittent faults that may only exist for a few milliseconds are latched long enough to be read by the controller. The amount of time to latch the errors will be based on the RPI, the safety task watchdog, and other application-specific variables.

3. Enter the Output Error Latch Time, the time the module holds an error to make sure the controller can detect it (0...65,530 ms, in increments of 10 ms—default 1000 ms).

This provides you more reliable diagnostics and enhances the changes that a nuisance error is detected. The purpose for latching output errors is to make sure that intermittent faults that may only exist for a few milliseconds are latched long enough to be read by the controller. The amount of time to latch the errors will be based on the RPI, the safety task watchdog, and other application-specific variables.

4. Click Apply.

Save and Download the Module Configuration

We recommend that you save your work after configuring a module. If the download is successful, you see a similar message to the message below.

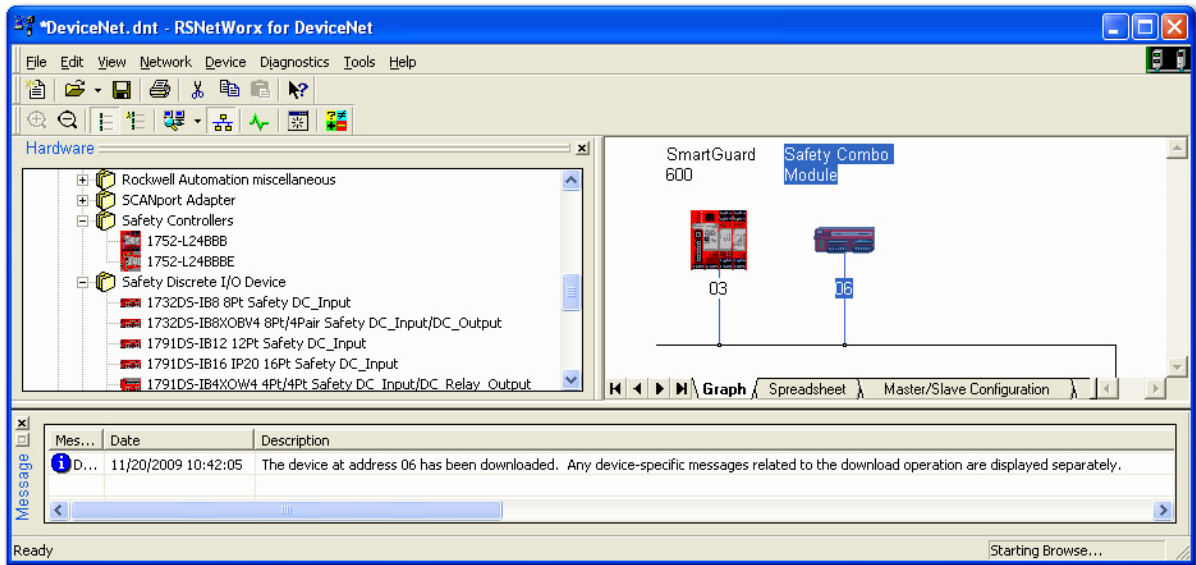

Set Up the 1791DS I/O Module Definition

Follow these steps to set up the 1791DS I/O module definition.

1. Right-click the SmartGuard controller and choose Properties.
2. Click the Safety Connection tab.

All 1791DS modules that the controller could make a safety connection to should appear in the list.

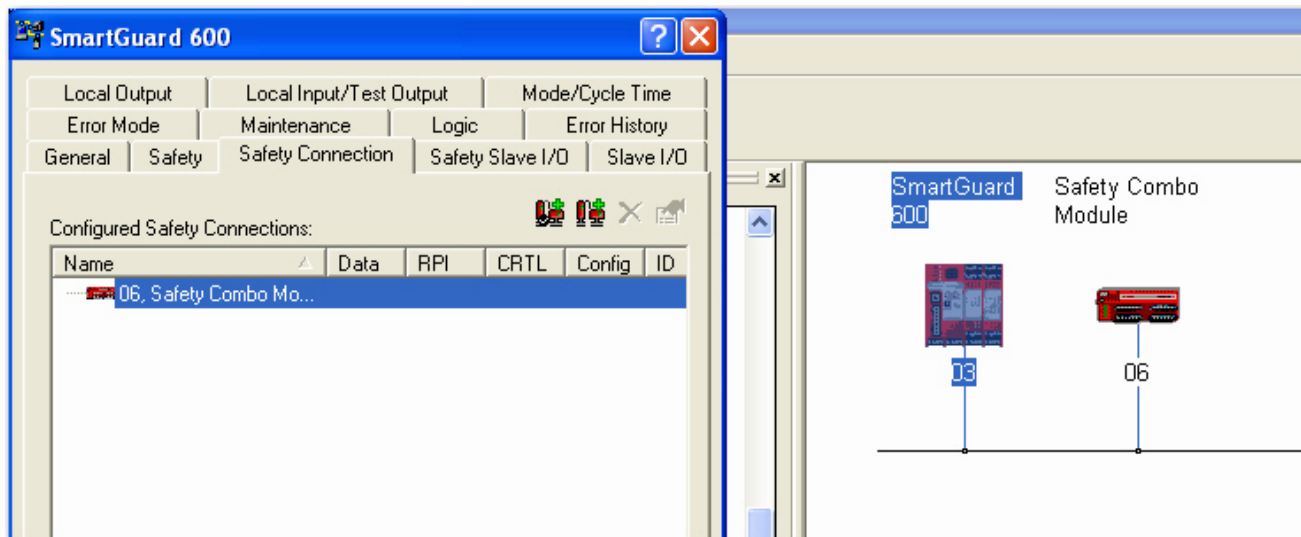

The rest of these steps assumes that the module is a combination input and output module. We describe how to add two connections: one of inputs and one of outputs. You can add individual safety connections for the inputs and outputs. SmartGuard 600 controller can have as many as 32 connections.

3. Right-click the I/O module and choose Add Connection.

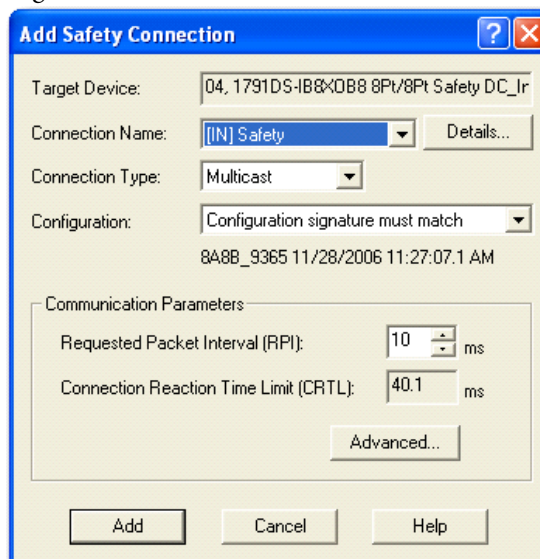

4. Choose the Connection Name from the pull-down menu.

Make your choice based on the input data and status needs of your application.

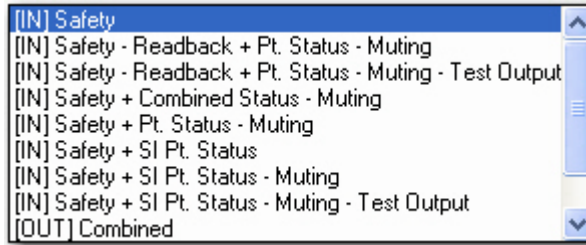



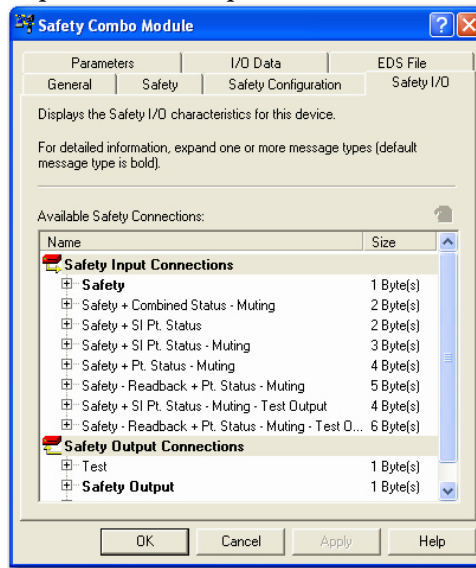



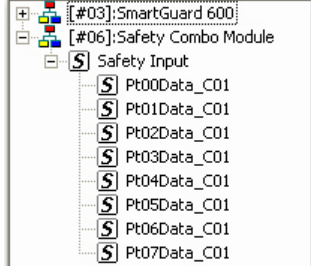

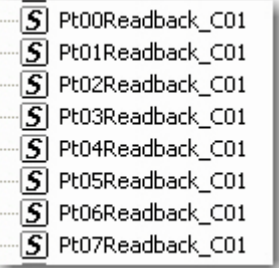







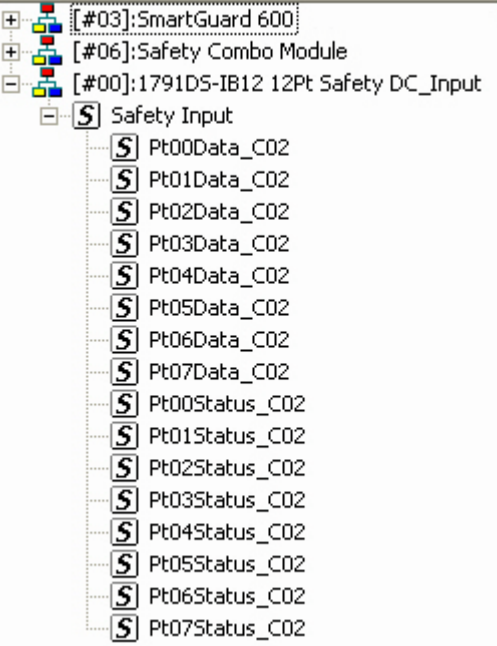











To see the specific data that will be generated for each connection name, in the 1791DS module properties dialog box click the Safety I/O tab. Expand each choice to see the tags created for input data, input status, output data, and output status.



5. Assign the input data.

Choose	Description
Safety	<p>The Safety Data tag for safety inputs from the module is created for the target module.</p> 

Choose	Description
Readback	<p>This option creates safety and readback tags, with readback indicating the presence of 24V on the output terminal. Safety-Readback is not available for input-only safety modules.</p>  <ul style="list-style-type: none">  Pt00Readback_C01  Pt01Readback_C01  Pt02Readback_C01  Pt03Readback_C01  Pt04Readback_C01  Pt05Readback_C01  Pt06Readback_C01  Pt07Readback_C01
Small Safety (1791DS-IB12 module only)	<p>This option is for 12-point safety input modules that use 8 or fewer safety inputs. The Small Safety option reduces the amount of data that the 12-point module sends to the controller to improve network performance. Safety data and point status tags are created. Point status is diagnostic status for each of the eight input points.</p>  <ul style="list-style-type: none">  [#03]:SmartGuard 600  [#06]:Safety Combo Module  [#00]:1791DS-IB12 12Pt Safety DC_Input <ul style="list-style-type: none">  Safety Input <ul style="list-style-type: none">  Pt00Data_C02  Pt01Data_C02  Pt02Data_C02  Pt03Data_C02  Pt04Data_C02  Pt05Data_C02  Pt06Data_C02  Pt07Data_C02  Pt00Status_C02  Pt01Status_C02  Pt02Status_C02  Pt03Status_C02  Pt04Status_C02  Pt05Status_C02  Pt06Status_C02  Pt07Status_C02

6. Assign the input status.

Choose	Description
None	There are no status tags, only data for the inputs.
Pt. Status	<p>There is one status tag for each input and output point.</p> <ul style="list-style-type: none"> <input type="checkbox"/> Pt00InputStatus_C01 <input type="checkbox"/> Pt01InputStatus_C01 <input type="checkbox"/> Pt02InputStatus_C01 <input type="checkbox"/> Pt03InputStatus_C01 <input type="checkbox"/> Pt04InputStatus_C01 <input type="checkbox"/> Pt05InputStatus_C01 <input type="checkbox"/> Pt06InputStatus_C01 <input type="checkbox"/> Pt07InputStatus_C01 <input type="checkbox"/> Pt00OutputStatus_C01 <input type="checkbox"/> Pt01OutputStatus_C01 <input type="checkbox"/> Pt02OutputStatus_C01 <input type="checkbox"/> Pt03OutputStatus_C01 <input type="checkbox"/> Pt04OutputStatus_C01 <input type="checkbox"/> Pt05OutputStatus_C01 <input type="checkbox"/> Pt06OutputStatus_C01 <input type="checkbox"/> Pt07OutputStatus_C01
Pt. Status - Muting	<p>There is a muting status tag for test output T3, T7, T11, and T15 with point status for each input and output point.</p> <ul style="list-style-type: none"> <input type="checkbox"/> Pt00InputStatus_C01 <input type="checkbox"/> Pt01InputStatus_C01 <input type="checkbox"/> Pt02InputStatus_C01 <input type="checkbox"/> Pt03InputStatus_C01 <input type="checkbox"/> Pt04InputStatus_C01 <input type="checkbox"/> Pt05InputStatus_C01 <input type="checkbox"/> Pt06InputStatus_C01 <input type="checkbox"/> Pt07InputStatus_C01 <input type="checkbox"/> Pt00OutputStatus_C01 <input type="checkbox"/> Pt01OutputStatus_C01 <input type="checkbox"/> Pt02OutputStatus_C01 <input type="checkbox"/> Pt03OutputStatus_C01 <input type="checkbox"/> Pt04OutputStatus_C01 <input type="checkbox"/> Pt05OutputStatus_C01 <input type="checkbox"/> Pt06OutputStatus_C01 <input type="checkbox"/> Pt07OutputStatus_C01 <input type="checkbox"/> Pt03MutingStatus_C01 <input type="checkbox"/> Pt07MutingStatus_C01

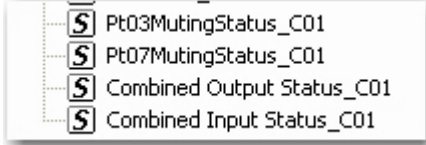
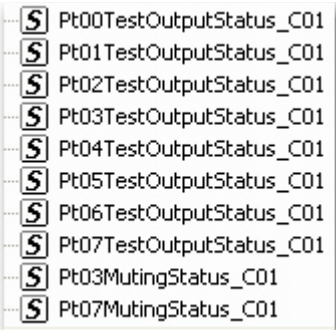
Choose	Description
Combined Status - Muting	<ul style="list-style-type: none"> •A single BOOL tag represents an AND of the status bits for all the input points. For example, if any input channel has a fault, this bit goes LO.⁽¹⁾ •A single BOOL tag represents an AND of the status bits for all the output points. •A muting status tag for test output T3, T7, T11, and T15. 
Pt. Status-Muting-Test Output	<ul style="list-style-type: none"> •Status tags for each of the input and output points. •Muting status tag for test output T3, T7, T11, and T15. •Status tags for each of the test outputs. 

(1) When using combined status, use explicit messaging to read individual point status for diagnostic purposes.

7. Assign the output data.

IMPORTANT The test outputs that are configured as standard outputs on the module must not be used for safety purposes.

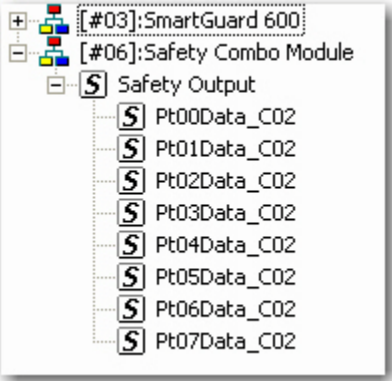
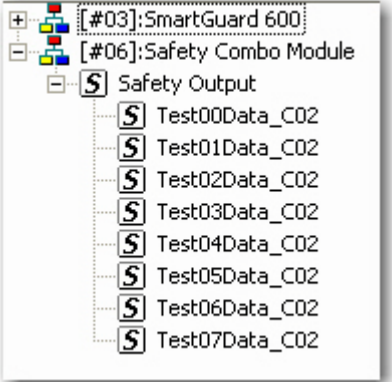
Choose	Description
None	Results in an input only connection to the module. Inputs and status are read, but no outputs are written.
Safety	<p>Creates these safety tags and enables these outputs for use in the safety task.</p> 
Test	<p>Creates these tags and enables the test outputs on the module. These outputs are standard outputs and must not be used for safety purposes.</p> 

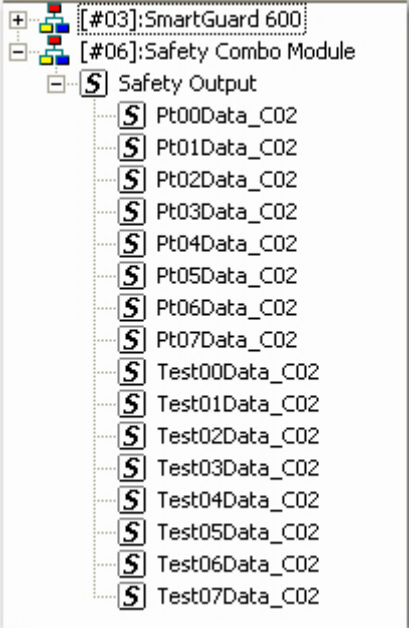
Choose	Description
Combined	<p>Creates these tags and enables all modules outputs, safety and test.</p>  <p>The screenshot shows a tree view with the following structure:</p> <ul style="list-style-type: none"> [#03]: SmartGuard 600 <ul style="list-style-type: none"> [#06]: Safety Combo Module <ul style="list-style-type: none"> Safety Output <ul style="list-style-type: none"> Pt00Data_C02 Pt01Data_C02 Pt02Data_C02 Pt03Data_C02 Pt04Data_C02 Pt05Data_C02 Pt06Data_C02 Pt07Data_C02 Test00Data_C02 Test01Data_C02 Test02Data_C02 Test03Data_C02 Test04Data_C02 Test05Data_C02 Test06Data_C02 Test07Data_C02

Typically, you should choose Combined Status for the input status. This limits the packet size for normal communication. If you need detailed status when a fault occurs, that data is read explicitly via MSG instructions.

Choose the appropriate input connection and add the output connection, if necessary.

Set the Connection Type

From the Connection Type pull-down menu, choose the appropriate connection type.

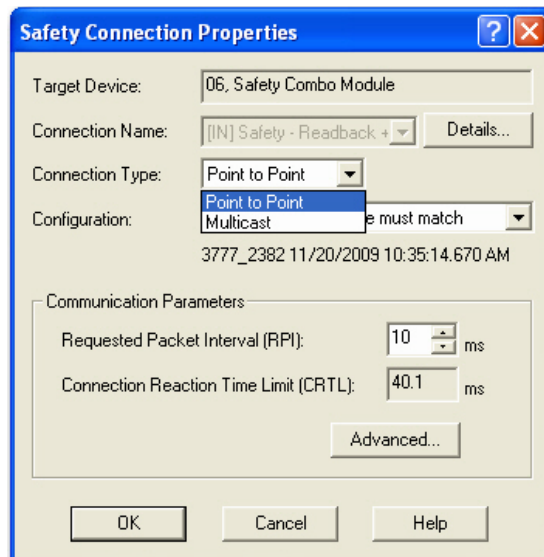

The Multicast connection type enables other safety controllers to read the safety input data by using this input connection. The Point to Point connection type does not enable this functionality.

For other safety controllers to use this safety connection to read the input data, the connections must be identical.

The RPI, connection name, and channel configuration must match so that this connection can be used by the other safety controller.

Set the Connection Configuration

The safety connection between a controller and I/O module is based on many items, one of which can be the configuration signature of the safety I/O module. If the configuration signature must match, the configuration signature must remain the same once the safety connection is established or the connection is broken.

To obtain SIL 3 integrity of a Guard I/O module, from the Configuration pull-down menu, choose 'Configuration signature must match'. For more information about the configuration signature, refer to [85](#).

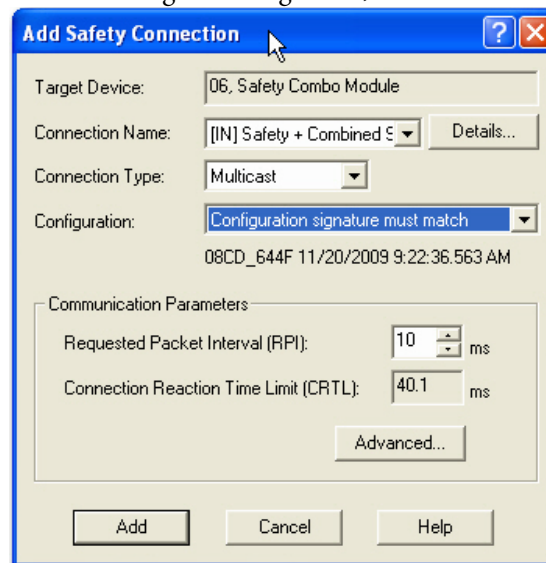

Set the Communication Parameters

Follow these steps to configure the communication parameters.

1. From the Add Safety Connection dialog box, click Advanced.

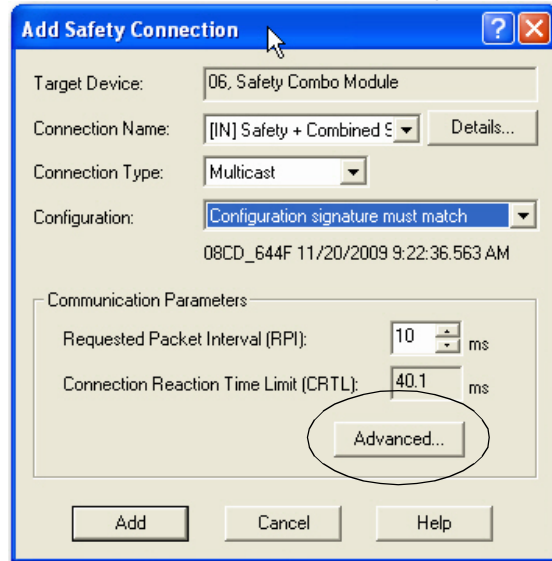

The Advanced Safety Connection Properties dialog box appears.



For more information about the Connection Reaction Time Limit, see the GuardLogix Controllers User Manual, publication [1756-UM020](#).

2. In the Requested Packet Interval (RPI) box, enter the input connection RPI to support your application (from 6...500 ms).

Selecting too small an RPI unnecessarily consumes network bandwidth; selecting too large an RPI increases safety reaction time. Selecting the appropriate RPI results in a system with optimized performance.

As an example, a safety input module with only ESTOP switches connected to it generally may work well with settings of 50...100 ms. An input module with a light curtain guarding a hazard may need the fastest response that is possible.

IMPORTANT Analyze each safety channel to determine what is appropriate. The default Time-out Multiplier of 2 and Network Delay Multiplier of 200 will create an input-connection reaction time limit of four times the RPI and an output-connection reaction time limit of three times the RPI. Changes to these parameters should be approved by a safety administrator.

TIP We recommend keeping the Time-out Multiplier and Network Delay Multiplier at their default values of 2 and 200.

A connection status tag exists that sums up all the safety I/O connections.

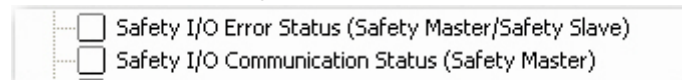

Safety I/O Error Status

OFF No errors.

ON Errors exist in one or more of the safety connections.

Safety I/O Communication Status

OFF Errors exist in one or more of the safety connections.

ON No errors.

When the connection reaction time limit and requested packet interval are set appropriately, these status tags should remain in their 'no errors' condition. Monitor these connection status bits to verify that they are not changing intermittently due to timeouts.

Configuration Ownership—Reset Ownership

The connection between the owner and the Guard I/O module is based on the following:

- Guard I/O DeviceNet node address
- Guard I/O safety network number
- GuardLogix slot number
- GuardLogix safety network number
- Path from GuardLogix controller to Guard I/O module
- Configuration signature

If any of these change, the connection between the controller and the Guard I/O module is lost. Reset the Guard I/O module to attempt to reestablish the connection by using this procedure.

The most common use of resetting the device is when the 1791DS module has previously had a safety connection to another controller. Until that prior owner is reset, the module will not make a new safety connection.

1. When online with the 1791DS module, right-click the module and choose Reset Safety Device.

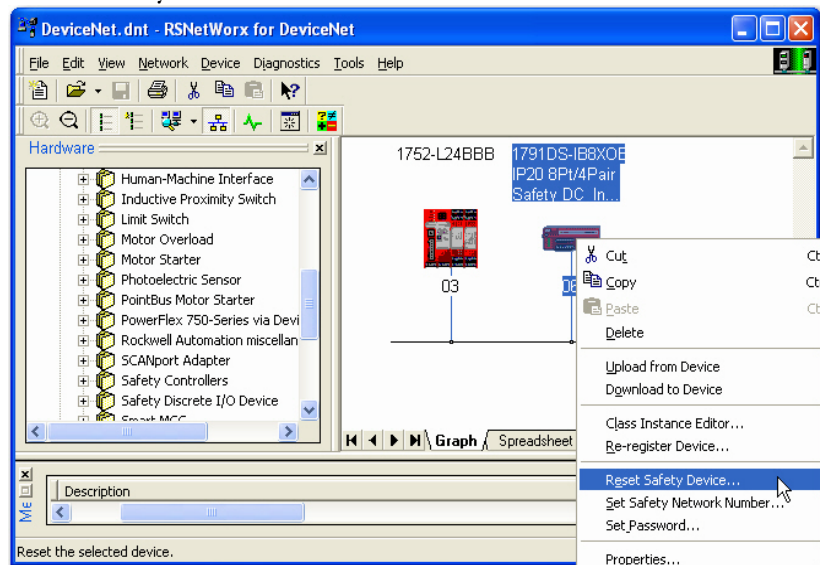

The Reset Safety Device dialog box appears.

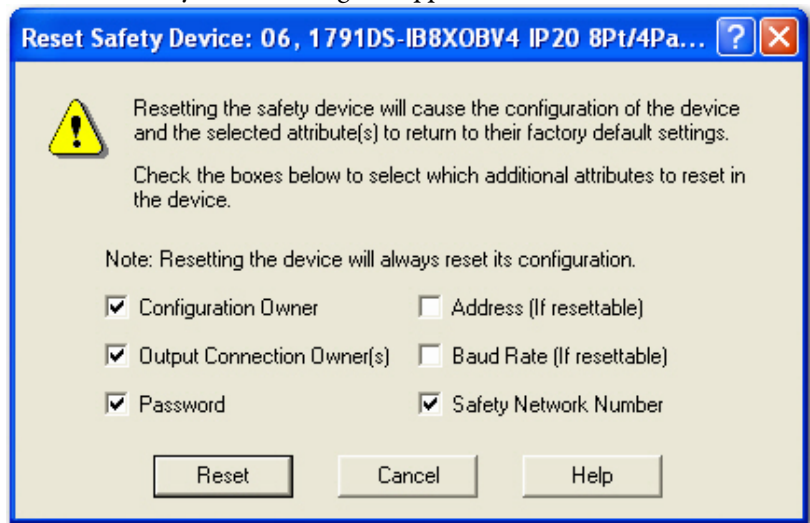

Configuration Owner and Output Connection Owner(s) are checked by default.

2. To reset the device to an out-of-box condition, check Password and Safety Network Number.

If you attempt to reset the device when a safety connection is active and the SmartGuard controller is in Run mode, you see this message.

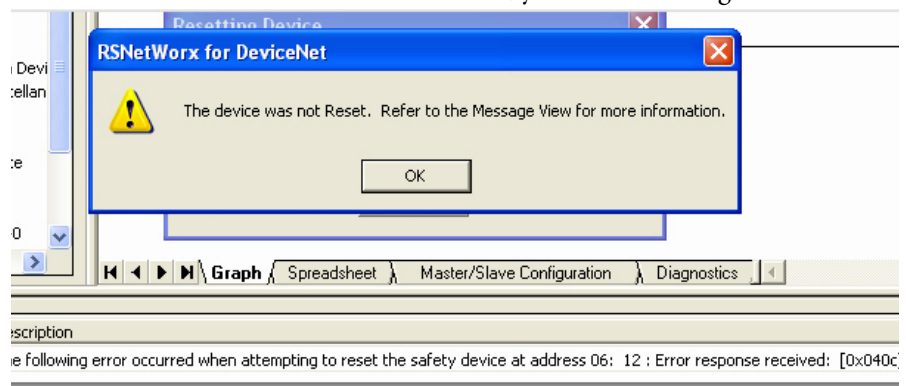

Put the SmartGuard controller into Idle mode and attempt to reset the 1791DS module again.

Set the Safety Network Number (SNN)

If you attempt to set the safety network number (SNN) when a safety connection is active and the SmartGuard controller is in Run mode, you see this message.

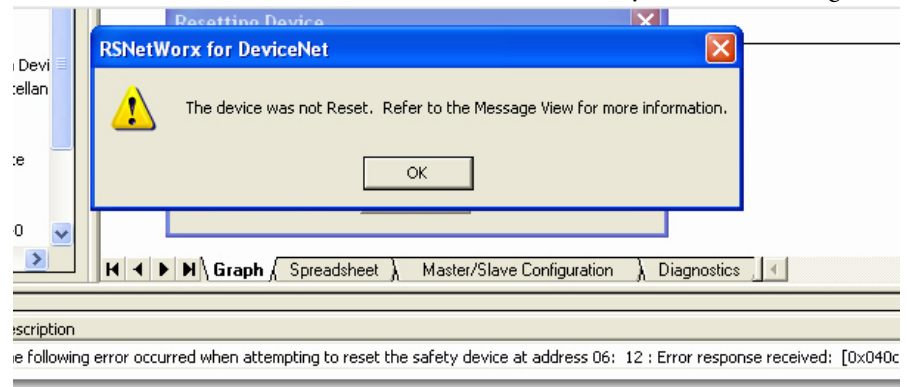

When you attempt to change the SNN, this dialog box appears.

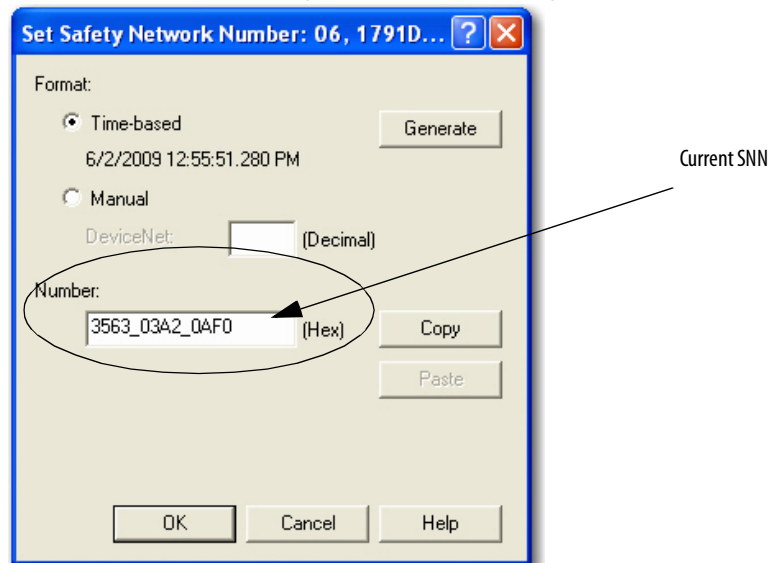

Follow these steps to change the SNN.

1. To change the SNN based on time, click Time-based and then click Generate.
2. To change the SNN based on a value of your own, click Manual and enter your value in the box.
3. Once you have your new SNN established, click OK.

The new SNN is sent to the 1791DS module. This dialog box appears informing you that the 1791DS configuration will be cleared when the SNN is changed.

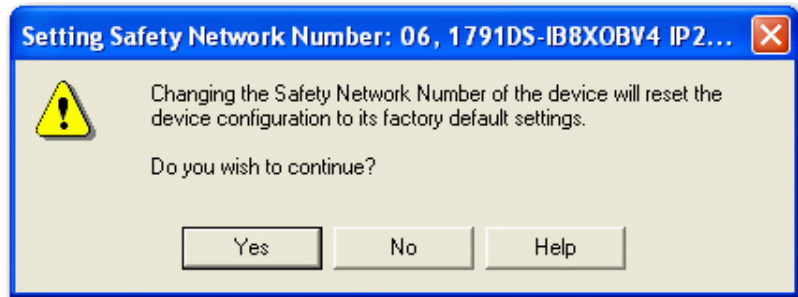

Next, this dialog box appears to allow you to confirm which module is about to have its SNN set.

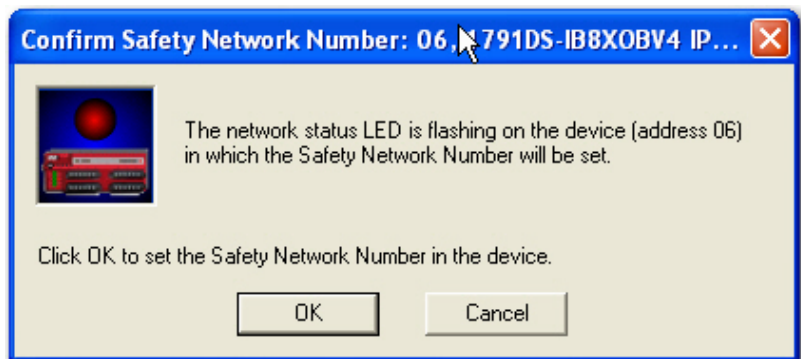

The network status indicator on the module that is about to have its SNN set is flashing red/green.

4. Click OK to confirm.

This dialog box appears and the network status indicator should stop flashing red/green.



Set Your Password

You can set a password so that the configuration of the 1791DS module cannot be changed without first entering the password. Use of this password is not required to obtain SIL 3 integrity, because the configuration signature is part of the safety connection. If the configuration signature changes, the safety connection is lost.

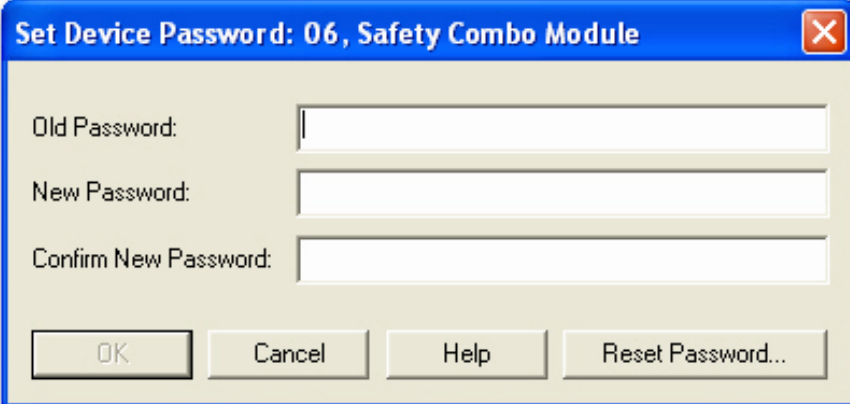

The dialog box is titled "Set Device Password: 06, Safety Combo Module". It contains three text input fields: "Old Password:", "New Password:", and "Confirm New Password:". Below the fields are four buttons: "OK", "Cancel", "Help", and "Reset Password...".

If you forget your password, you must contact Rockwell Automation to have it reset.



The dialog box is titled "Reset Device Password: 06, Safety Combo Module". It features a yellow warning triangle icon and the following text: "Resetting the device password will remove the password from the device. Upon completing this operation it is recommended that a new password be set in the device." Below this is a "Device Details" section with two input fields: "Serial Number:" containing "004958CC" and "Security Code:" containing "000100". Further down, it says "To reset the device password, contact the device vendor for your Vendor Password and enter it below:" followed by an empty text input field. At the bottom are three buttons: "OK", "Cancel", and "Help".

I/O Data Tab

You can put the 1791DS module in the scan list of a DeviceNet scanner, for example, a 1756-DNB bridge module.

The 1791DS module will automatically appear in your list of available devices. Open the properties for the 1756-DNB module and click the Scanlist tab.

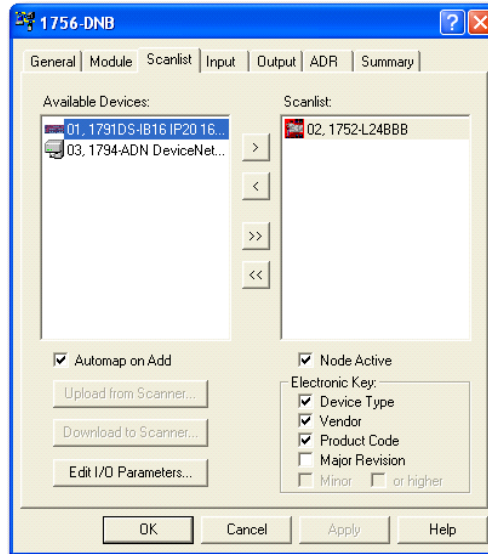

The 1791DS module has preconfigured options for reading (and writing) standard data. To view them, open the properties of the 1791DS module and click the I/O Data tab. These sizes and data contained within them cannot be altered.

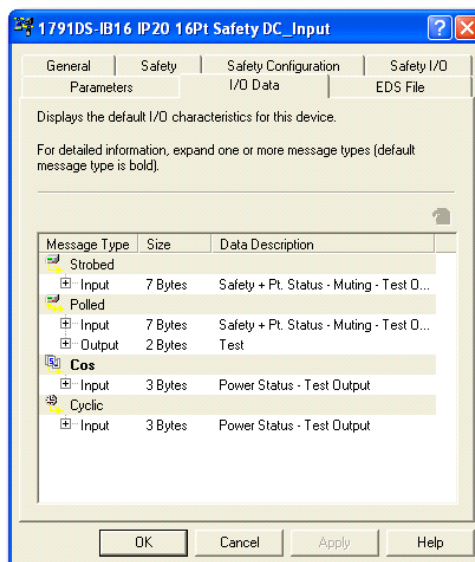

These message types will appear differently, depending on the safety I/O module you select, but in general the:

- bit-strobe and polled connections provide the I/O data values and channel status.
- polled connection can write standard data to the I/O module. Only use this if the test outputs are configured as standard outputs, and those standard outputs can then be controlled from the scanner.
- change of state (COS) and cyclic connections provide power status, which cannot be obtained from bit strobe or polled connections.

Troubleshooting

If you attempt to go into Execute mode after a change is made to the 1791DS module (which breaks the safety connection to the SmartGuard controller), you will see the D6 message on the SmartGuard controller's ASCII display.

To resolve this anomaly, in the SmartGuard 600 properties dialog box, click the Safety Connection tab. This message appears if there has been an update to a 1791DS module that is not reflected in the offline configuration.

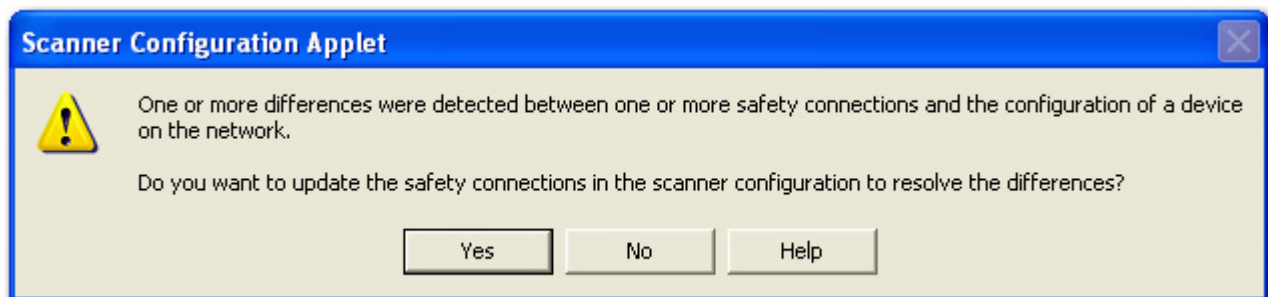

Click Yes to resolve those differences. Next, click Apply and then Yes to download the updated software changes to the SmartGuard 600 controller.

If the differences are resolved, you can go into Execute mode without seeing the D6 message on the SmartGuard controller's ASCII display.

If you see the following message after attempting to download, the likely scenario is that the 1791DS module was previously owned by a different safety controller. You must reset the owner before the 1791DS module will make a new safety connection.

Address 06: The standard configuration data was downloaded successfully.
 Address 06: The error 'Configuration owned by remote device at address 00, SNN 0001_0000_0065 (Incorrect Network Type.)' occurred while attempting to configure the safety device.

To reset the 1791DS module, right-click the module and choose Reset Safety Device.

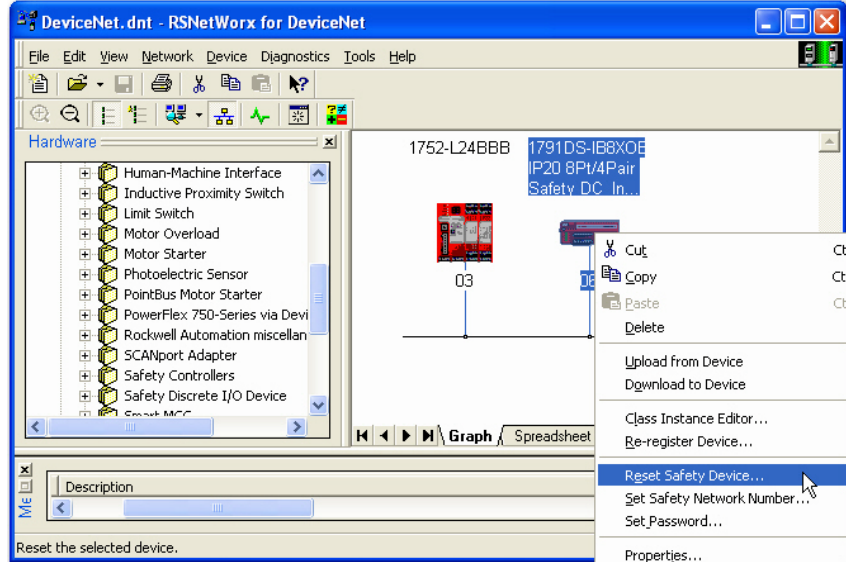

The Reset Safety Device dialog box appears.

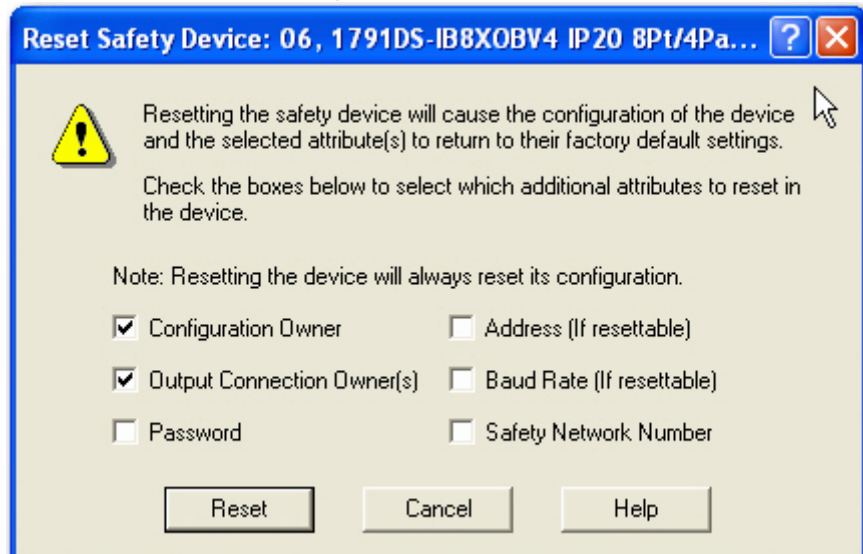

Check Password and Safety Network Number so that the 1791DS module is totally reset. Click Reset.

If the reset is successful, you see this message.

Description

The safety device at address 06 has been reset, including the following attributes: Configuration, Configuration Owner, Output Connection Owners, Password and Safety Network Number.

Note that the configuration owner is now reset, so the 1791DS module can connect to a new owner, that is, the SmartGuard controller.

When you browse the network, the 1791DS module appears like this.

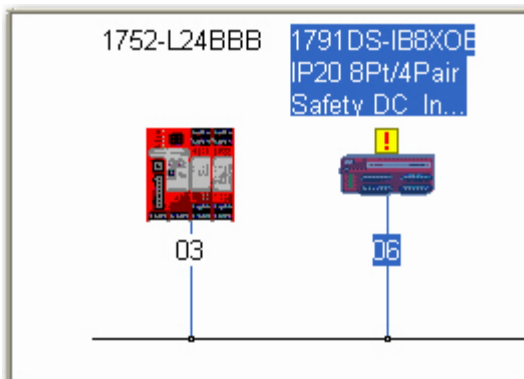

The exclamation point means the SNN has not been set (as shown below). This makes sense because the device has just been reset.

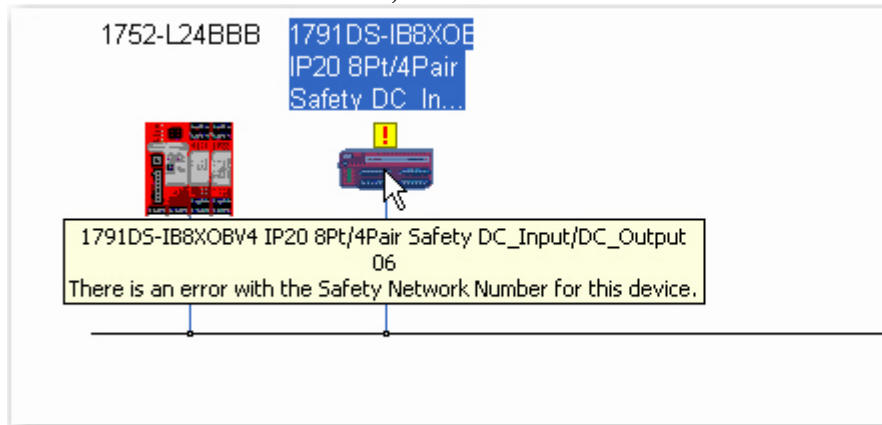

Double-click the module. This dialog box appears.

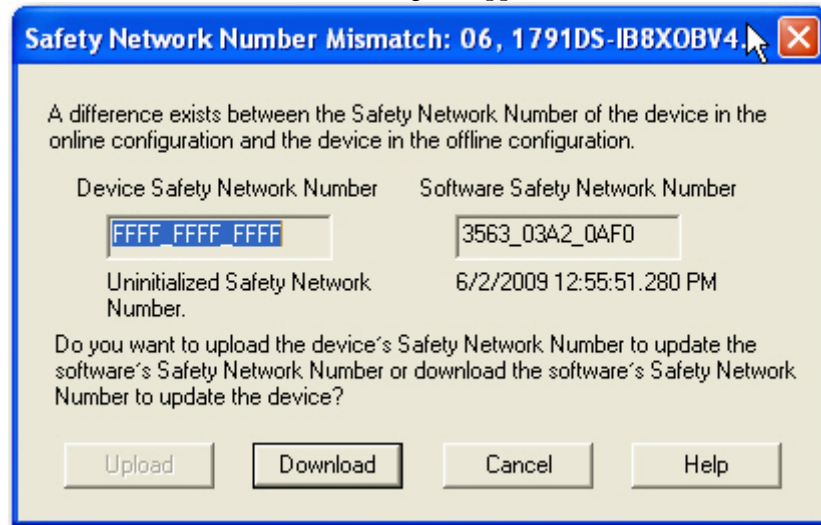

The SNN that exists in the 1791DS module does not match what is in RSNetWorx for DeviceNet software. For more information about the SNN, see [83](#).

Click Download. This dialog box appears.

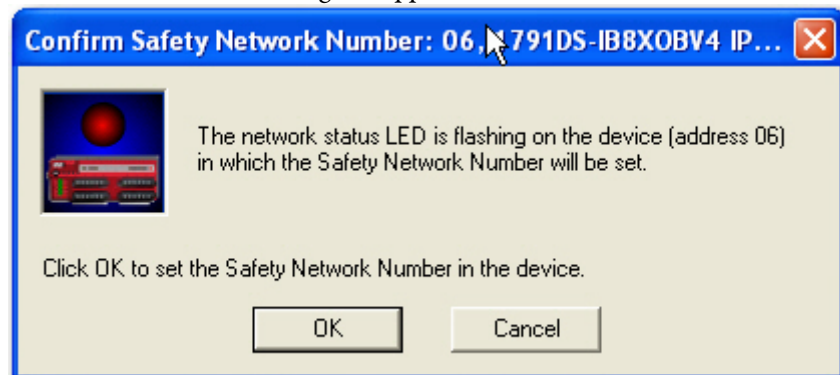

This lets you confirm which 1791DS module is about to have its SNN set. The network status indicator on the module that is about to have its SNN set is flashing red/green. Click OK to confirm the set.

This dialog box appears and the network status indicator on the affected module stops flashing red/green.



Click OK. This dialog box appears.

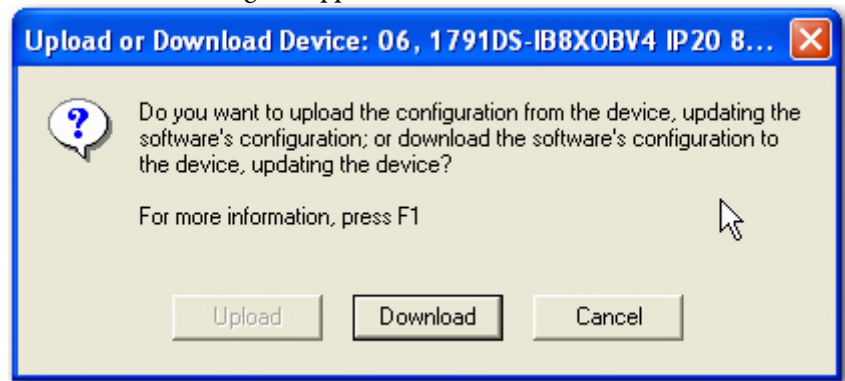

Click Download to complete the download of your new configuration.

Notes:

Considerations When Replacing Guard I/O Modules

Topic	Page
Considerations When Replacing Guard I/O Modules	115
Replacing an I/O Module When Using a SmartGuard Controller	117
Replacing an I/O Module When Using a GuardLogix Controller	121

This chapter provides things to consider when replacing Guard I/O modules when they are connected to GuardLogix or SmartGuard controllers. For more information, refer to the controller user manuals listed in the Additional Resources on page [10](#).

Considerations When Replacing Guard I/O Modules

When Guard I/O modules are connected to a GuardLogix or SmartGuard controller, consider the following when replacing the modules.

The topic of replacing a safety I/O module that sits on a DeviceNet network is more complicated than standard devices because of the safety network number (SNN). The node number (Mac ID) and SNN make up the safety node's identifier. Safety devices require this more complex identifier to guarantee that duplicate node numbers do not compromise communication between the correct nodes.

The DeviceNet network supports 64 node numbers, so if you have 100 devices on multiple DeviceNet networks, there are at least 36 duplicate node numbers being used. Even though the duplicate nodes are on separate DeviceNet networks, this must still be considered in a safety system.

In this example, the DNB scanner #1 is connected to node 5. The DNB scanner #2 is connected to another node 5. If the cables get inadvertently crossed, the scanners may be communicating with the incorrect node 5.

Figure 25 - Crossed Cable Example

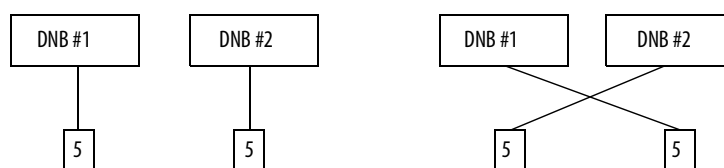

This crossed-cable scenario is unacceptable for a safety system. The SNN guarantees unique identification of every safety device. In this next example, all of the devices connected to DNB scanner #1 have an SNN of 100. All devices connected to DNB scanner #2 have an SNN of 101. If the cables get inadvertently crossed, the node connected to DNB scanner #1 changes from 100/5 to 101/5. The node connected to DNB scanner #2 changes from 101/5 to 100/5. Therefore, the safety connections are **not** made if the cables get crossed.

Figure 26 - Connections Not Made Example

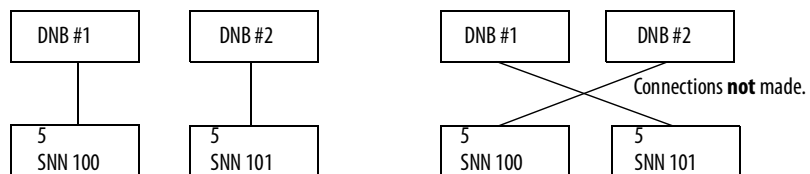

Why You Need to Manually Set the SNN

The examples above showed how the SNN is used to guarantee safety-connection integrity after the system is operational. But the SNN is also used to guarantee integrity on the initial download to the Guard I/O module.

If a safety signature exists, then the Guard I/O module must have a proper SNN/node number identification that matches the module within the project, before it can receive its configuration. And to keep integrity, the setting of the module's SNN is **required** to be a manual action. This manual action is to use the 'set' function on an out-of-box Guard I/O module.

Figure 27 - Setting the SNN with a GuardLogix Controller

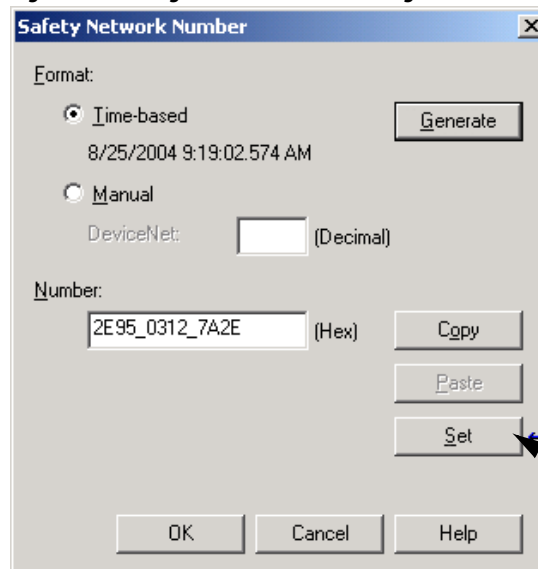
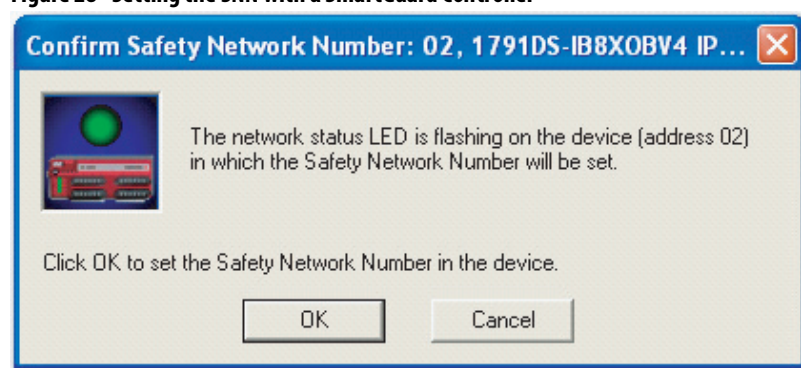

Figure 28 - Setting the SNN with a SmartGuard Controller



GuardLogix Controllers versus SmartGuard Controllers

There is one major difference in functionality between the GuardLogix and SmartGuard safety controllers that affects the replacement of safety I/O modules. GuardLogix controllers retain I/O module configuration on-board and are able to download the configuration to the replacement module. SmartGuard controllers do not retain I/O module configuration so you need to use RSNetWorx for DeviceNet software to download the configuration to the replacement module.

Replacing an I/O Module When Using a SmartGuard Controller

Follow these steps to replace an I/O module when using a SmartGuard controller.

1. Set the rotary switches of the replacement module to match the node number of the original module.
2. In RSNetWorx for DeviceNet software, open your project.

If the replacement module is out-of-box or has an SNN that does not match the original module, the module appears with an exclamation mark.

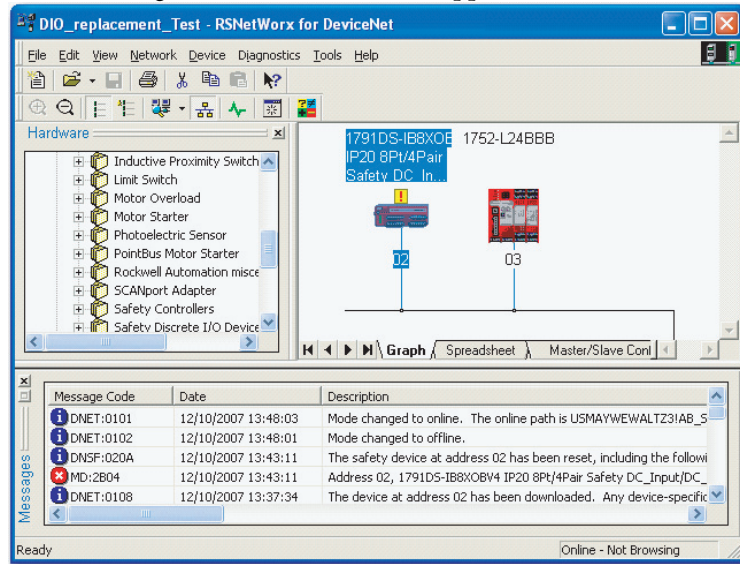

3. Right-click the module and choose Download to Device.

This dialog box appears.

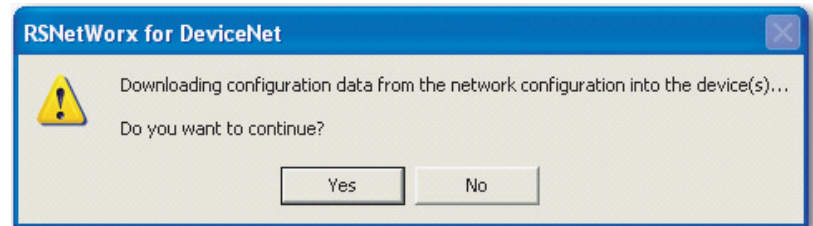

4. Click Yes.

This dialog box appears informing you that the SNN of the replacement module does not match the SNN in the software.

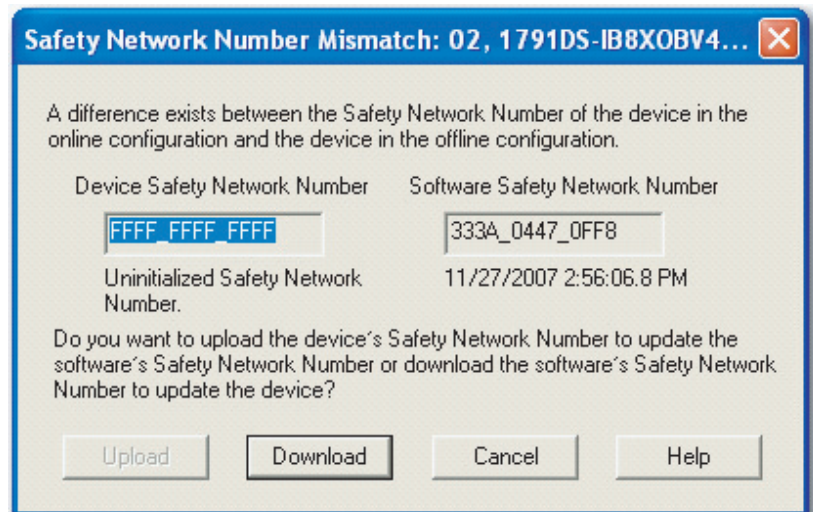

5. Click Download to set the SNN on the replacement module.

This dialog box appears.

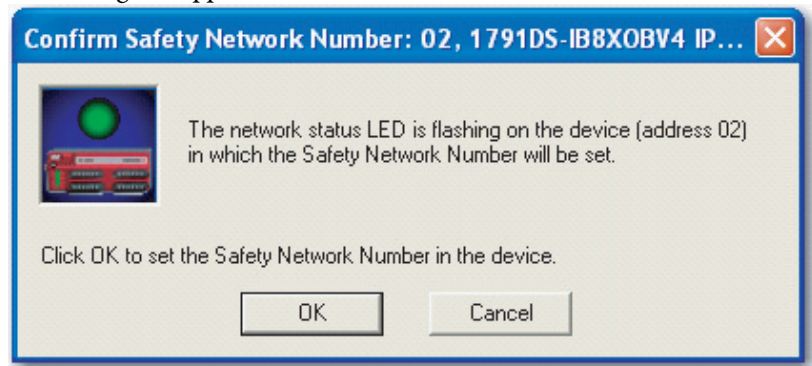

6. Click OK.

This dialog box appears, confirming that the SNN has been set.



The download now occurs. Once completed successfully, you see this message in the main project view: 'The device at address xx has been downloaded. Any device-specific messages related to the download operation are displayed separately.'

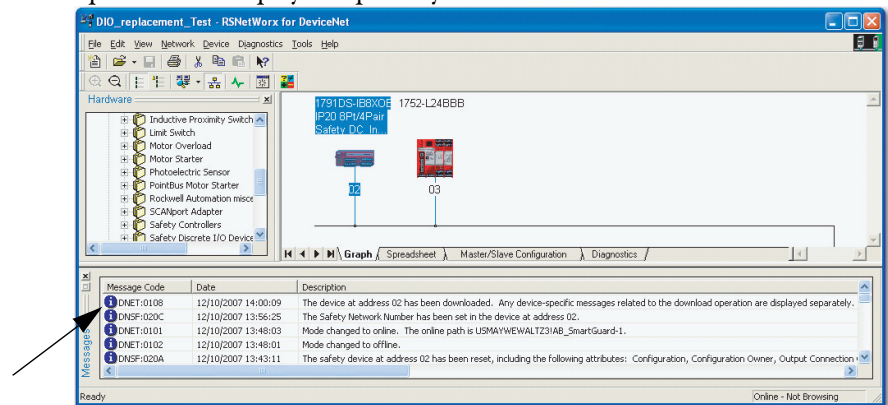

Assuming this is the proper configuration from the original DNT file, the SNN and configuration signature now match that of the original. If you are already connected to the SmartGuard controller, a connection is made. The SmartGuard controller does not need to be taken out of RUN mode to download to the replacement module.

If you download this configuration to a temporary setup, place the module on the network and it automatically connects to the SmartGuard controller.

If the configuration downloaded to the module was not from the original DNT file, the configuration signature will not match the original. Even if you recreate the same parameters in a new DNT file, the time and date portions of the signature will be different so the connection to the SmartGuard controller is not made. If this occurs, click the Safety Connection tab for the SmartGuard controller that prompts you that the signature is different and provides you with the option to match the new signature. However, you should first re-validate the safety system, because it is not using the original DNT file.

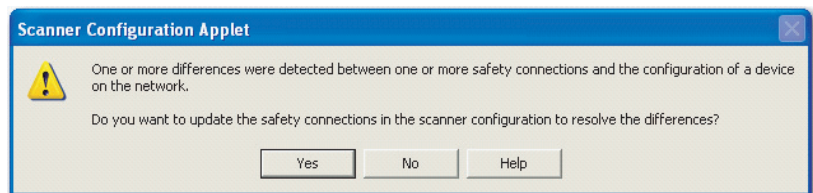

7. Click Yes.

This takes the SmartGuard controller out of RUN mode.

You see this dialog box.

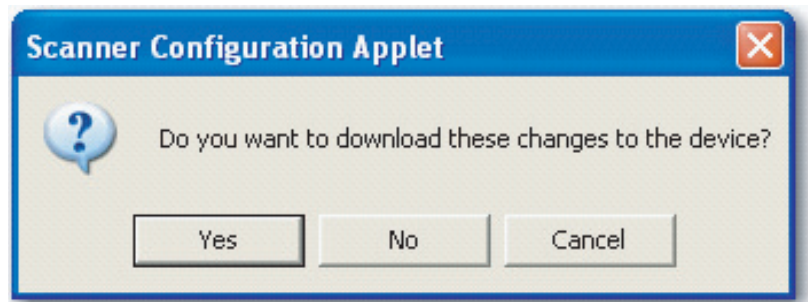

8. Click Yes to download the new connection configuration to the SmartGuard controller.

After the download is complete, place the SmartGuard controller back in RUN mode and the connection to the replacement module is established.

Replacing an I/O Module When Using a GuardLogix Controller

Follow the appropriate steps to replace an I/O module when using a GuardLogix controller.

I/O Replacement with 'Configure Only When No Safety Signature Exists' Enabled

IMPORTANT

If you use a GuardLogix controller for SIL 3 during module replacement and functional testing, then you must choose 'Configure Only When No Safety Signature Exists'. This option makes sure that if a safety signature exists (and you must have a safety signature to be SIL 3), that the safety network number (SNN) of the replacement distributed I/O module must match that of the GuardLogix controller before a connection between them can be made.

If a safety signature exists, clicking Set downloads the correct SNN from the correct GuardLogix project to the replacement module. The only exception would be when the SNN is already the same as the replacement module, in which case no action is required.

Once the correct SNN has been downloaded to the Guard I/O module, the GuardLogix controller automatically configures the module.

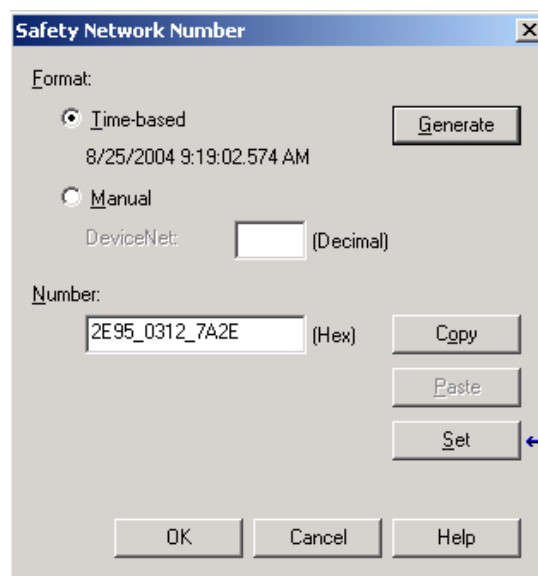

If the project is configured as ‘Configure Only When No Safety Signature Exists’, follow the appropriate steps to replace a Guard I/O module based on your scenario.

GuardLogix Project Safety Signature Exists	Replacement Module SNN	Fault	Action Required
Yes	Out-of-box	SNN not set, device out-of-box	Click Set. Refer to Scenario 1 - New Module is Out-of-box and Safety Signature Exists on page 122.
No	Out-of-box	None	None.
Yes or No	Same as original	None	None.
Yes	Different from original	SNN mismatch SNN not set, device out-of-box	1. Click Reset Ownership. 2. Click Set. Refer to Scenario 2 - New Module SNN is Different from Original and Safety Signature Exists on page 123.
No	Different from original	SNN mismatch	Click Reset Ownership. Refer to Scenario 3 - New Module SNN is Different from Original and No Safety Signature Exists on page 124.

Scenario 1 - New Module is Out-of-box and Safety Signature Exists

1. Remove the old I/O module and install the new module.
2. Right-click your GuardLogix controller and choose Properties.
3. Click **...** to the right of the safety network number to open the Safety Network Number dialog box.

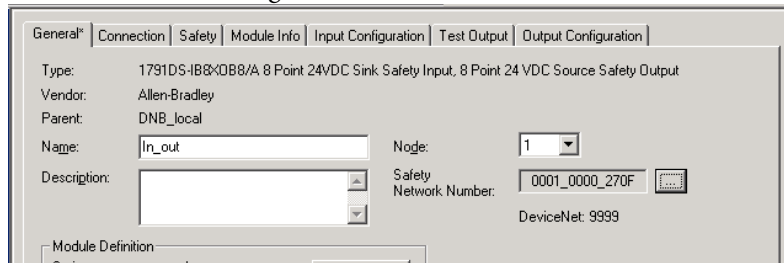

4. Click Set.

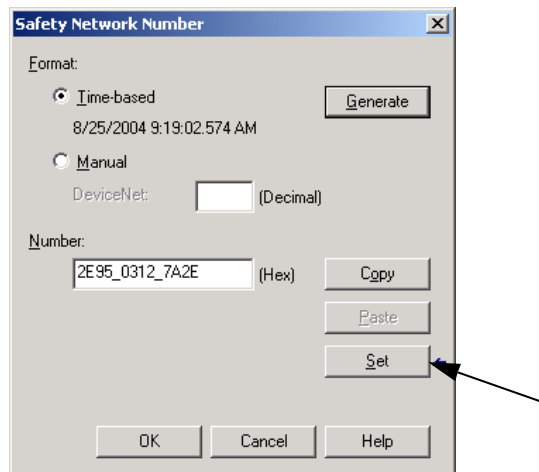

The Set Safety Network Number in Module confirmation dialog box appears.

5. Verify that the Network Status (NS) status indicator is alternating red/green on the correct module before clicking Yes to set the SNN and accept the replacement module.

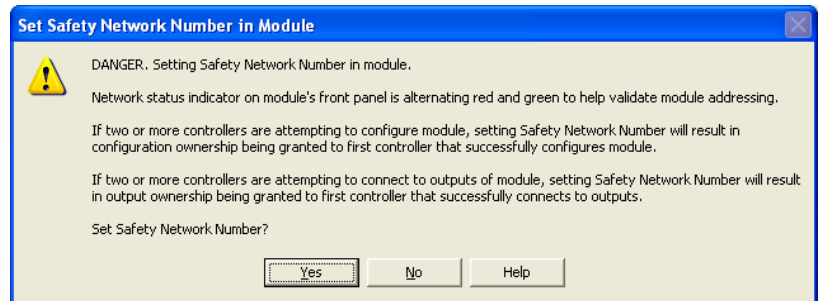

6. Follow your company-prescribed procedures to functionally test the replaced I/O module and system and to authorize the system for use.

Scenario 2 - New Module SNN is Different from Original and Safety Signature Exists

1. Remove the old I/O module and install the new module.
2. Right-click your Guard I/O module and choose Properties.
3. Click the Safety tab.

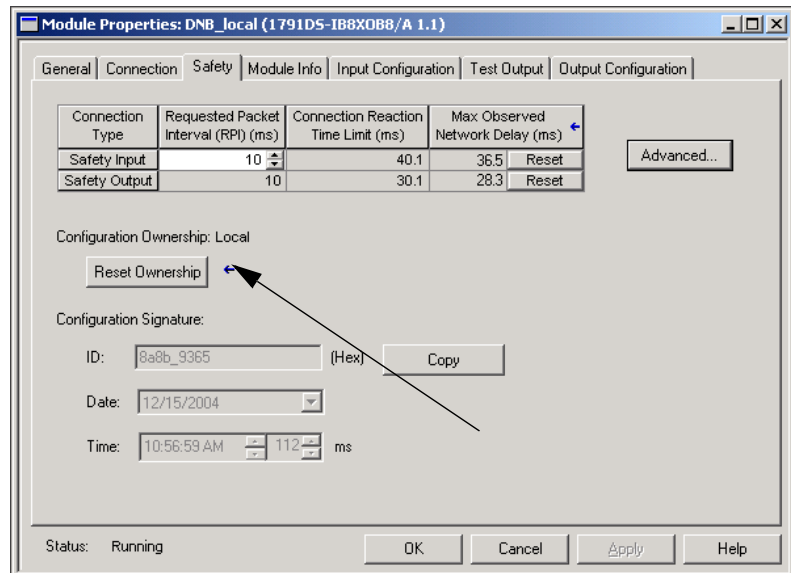

4. Click Reset Ownership.
5. Click OK.
6. Right-click your GuardLogix controller and choose Properties.

- Click ... to the right of the safety network number to open the Safety Network Number dialog box.

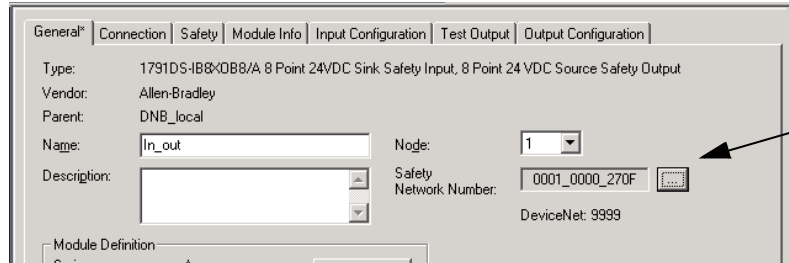

- Click Set.

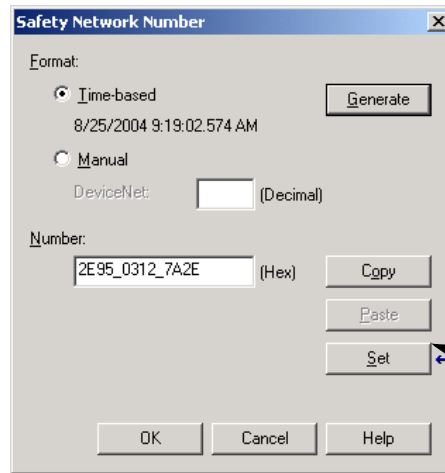

The Set Safety Network Number in Module confirmation dialog box appears.

- Verify that the Network Status (NS) status indicator is alternating red/green on the correct module before clicking Yes to set the SNN and accept the replacement module.

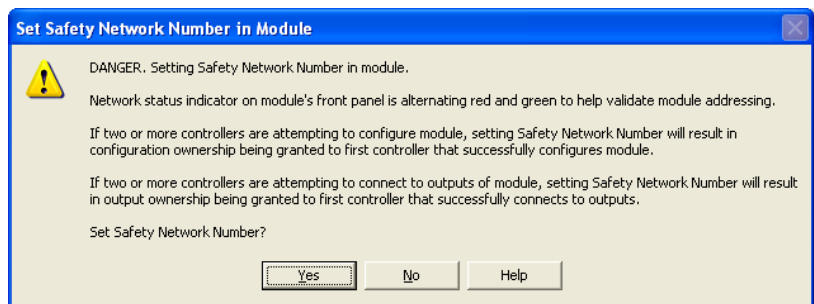

- Follow your company-prescribed procedures to functionally test the replaced I/O module and system and to authorize the system for use.

Scenario 3 - New Module SNN is Different from Original and No Safety Signature Exists

- Remove the old I/O module and install the new module.
- Right-click your Guard I/O module and choose Properties.

3. Click the Safety tab.

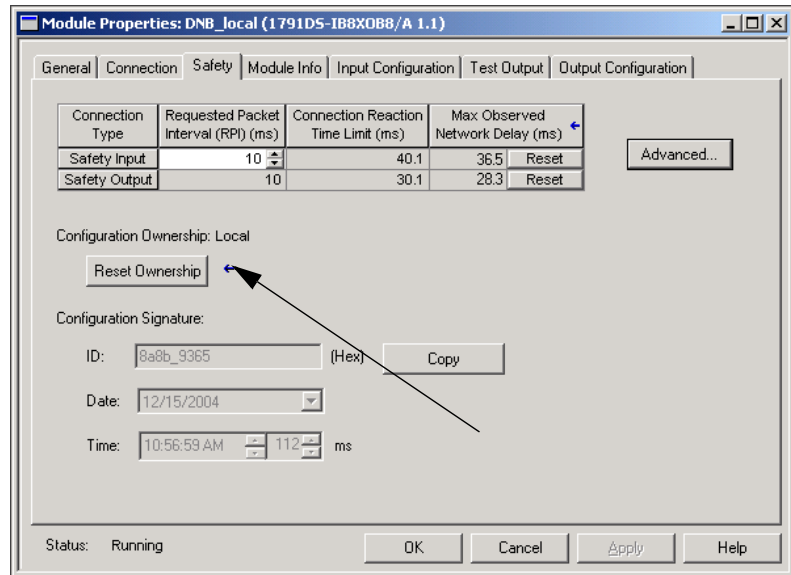

4. Click Reset Ownership.
5. Click OK.
6. Follow your company-prescribed procedures to functionally test the replaced I/O module and system and to authorize the system for use.

I/O Replacement with 'Configure Always' Enabled



ATTENTION: Enable the 'Configure Always' feature only if the entire CIP Safety Control System is **not** being relied on to maintain SIL 3 behavior during the replacement and functional testing of a module.

When the 'Configure Always' feature is enabled, the controller automatically checks for and connects to a replacement module that meets all of the following requirements:

- The controller has configuration data for a compatible module at that network address.
- The module is in out-of-box condition or has an SNN that matches the configuration.

Although chances are small, this allows the possibility of the wrong controller taking ownership of the replacement module.

For modules with different SNNs, clicking Reset Ownership places the module in an out-of-box condition. Once in out-of-box mode, no action is needed for the GuardLogix controller to take ownership of the module.

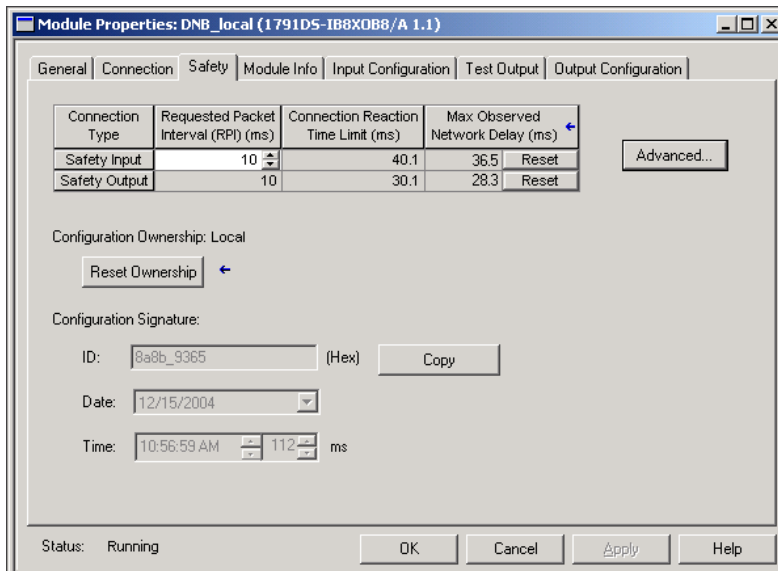

If the project is configured for 'Configure Always', follow the appropriate steps to replace a Guard I/O module based on your scenario.

GuardLogix Project Safety Signature Exists	Replacement Module SNN	Fault	Action Required
Yes or No	Out-of-box	None	None.
Yes or No	Same as original	None	None.
Yes or No	Different from original	SNN mismatch	Click Reset Ownership. Follow the steps below.

1. Remove the old I/O module and install the new module.
2. Right-click your Guard I/O module and choose Properties.
3. Click the Safety tab.

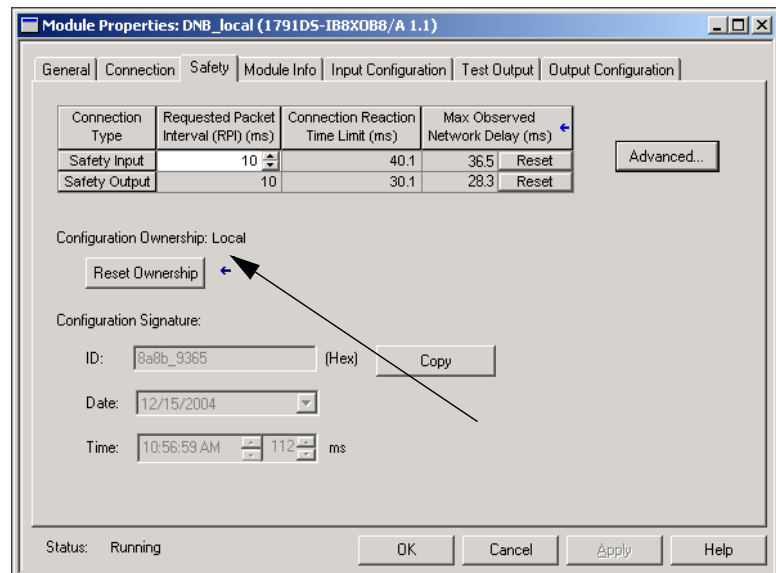

4. Click Reset Ownership.
5. Click OK.
6. Follow your company-prescribed procedures to functionally test the replaced I/O module and system and to authorize the system for use.

Notes:

Interpret Status Indicators

Topic	Page
Module Indicators	129
Module Status and Network Status Indicators Combination	130
1791DS-IB12, 1791DS-IB8XOB8, and 1791DS-IB4XOW4 Status Indicators	131
1732DS-IB8XOBV4, 1732DS-IB8, 1791DS-IB8XOBV4, and 1791DS-IB16 Status Indicators	133

Module Indicators





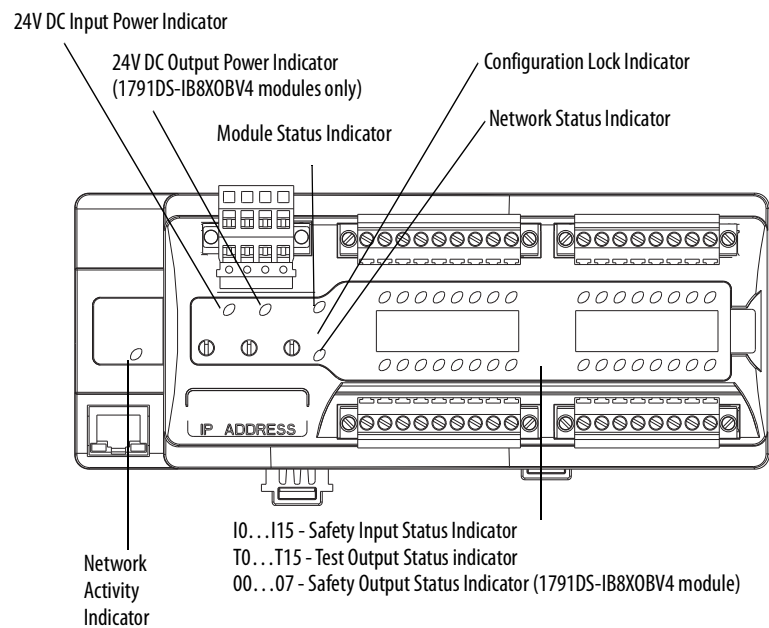















See the figure and tables for information on how to interpret LED module indicators.

Figure 29 - LED Module Indicators



Module Status and Network Status Indicators Combination

The Module Status (MS) indicator displays the status of a node on the network. The Network Status (NS) indicator displays the status of the entire network. See the table for meanings indicated by the combination of colors and status.

State	Status	Description	Recommended Action
 Solid green  Solid green	Normal operation Online/connected	Safety I/O communication in progress.	None - normal status - safety I/O communication and standard I/O communication are being performed.
 Flashing green  Solid green	Standby Online/connected	Standard I/O communication or message communication in progress.	None - normal status - standard I/O communication and/or message communication are being performed.
 Flashing green  Off	Standby Not online or not powered	Waiting for completion of node address duplication check at the master.	If this indicator status occurred for only specific module terminals, check that the module communication rate settings are correct and restart the module.
 Flashing green  Flashing green	Standby Online/not connected	Waiting for safety or standard connection.	None - wait for connection to complete.
 Flashing green/red  Off	Initialization status Not online or not powered	Module performing initialization process or waiting for configuration.	None - wait for process or configuration to complete.
 Solid red  Off	Fatal fault Not online or not powered	Watchdog timer error.	Replace the module.
 Flashing red  Off	Minor fault Not online or not powered	Switch settings are incorrect.	Check the switch settings and restart the module.
 Flashing green  Solid red	Standby Fatal link fault	Node address duplication.	Reset the module so that it has a unique node address, and then restart the module.
 Flashing green  Solid red	Standby Fatal link fault	Bus Off status (communication stopped due to consecutive data errors).	Check the following items and restart the module: <ul style="list-style-type: none"> -Do master and module communication rates match? -Are lengths of cables (trunk and branch lines) correct? -Are cables broken or loose? -Are terminating resistors connected to both ends of the trunk line only? -Is noise interference excessive?
 Flashing Green  Flashing red	Standby Minor communication fault	Communication timeout.	Check the following items and restart the module: <ul style="list-style-type: none"> -Do master and module communication rates match? -Are lengths of cables (trunk and branch lines) correct? -Are cables broken or loose? -Are terminating resistors connected to both ends of the trunk line only? -Is noise interference excessive? -Is the network grounded properly ?

 : Lit  : Flashing  : Not lit

1791DS-IB12, 1791DS-IB8XOB8, and 1791DS-IB4XOW4 Status Indicators

Refer to the tables for information on how to interpret status indicators on the 1791DS-IB12, 1791DS-IB8XOB8, and 1791DS-IB4XOW4 modules.

Table 3 - Module Status (MS) Indicator

State	Status	Description	Recommended Action
Solid green	Normal	Normal operating status.	None- normal operation.
Flashing green	Standby	Waiting for safety communication from the safety controller.	Wait for module to establish communication.
Solid red	Fatal fault	Hardware fault.	Check for electrical noise and eliminate the source. If the anomaly persists, replace the module.
Flashing red	Minor fault	Switch settings incorrect.	Correct the switch settings.
Flashing green/ red	Initialization status	The module is performing initialization process or waiting for configuration.	Wait for the configuration to complete.
Off	No power	Power is not being supplied to the module.	Supply power to the module.
		Waiting for initial processing to start.	Wait for processing to start.
		The module is being reset.	Wait for the module to reset.

Table 4 - Network Status (NS) Indicator

State	Status	Description	Recommended Action
Solid green	Online/connected	Network is operating normally (communication established).	None - normal operation.
Flashing green	Online/not connected	Network is operating normally, however, communication is not established.	Verify your network and module configuration.
Solid red	Fatal link failure	Communication fault.	Correct the communication fault.
		Module detected that network communication is not possible.	
		Node address duplication detected.	
		Abusive fault detected.	
Flashing red	Minor communication fault	Communication timeout.	Correct the communication fault.
Off	Not online or not powered	Waiting for node address duplication check at the master.	Wait for check to complete.
		The power supply is off.	Apply power.

Table 5 - Configuration Lock (LOCK) Indicator

State	Status	Description	Recommended Action
Solid yellow	Normal and locked	Normal configuration, and configuration is locked by RSNetWorx for DeviceNet software.	None.
Flashing yellow	Normal and not locked	Normal configuration, but configuration is not locked in the module.	None.
Off	Configuration not performed	Configuration has not been performed.	Perform the configuration.

Table 6 - Input Power (IN PWR) Indicator

State	Status	Description	Recommended Action
Solid green	Normal	Normal status of input power.	None.
Off	No input power	Input power is not supplied.	Apply input power.

Table 7 - Output Power (OUT PWR) Indicator

State	Status	Description	Recommended Action
Solid green	Normal	Normal status of output power.	None.
Off	No output power	Output power is not supplied.	Supply output power.
	Output power exceeds power range	Output power exceeds the upper/lower limit of power range.	Correct output power.

IMPORTANT The I/O indicators are not lit while the module is being configured.

Table 8 - Input (IN0 through INn⁽¹⁾) Indicators

State	Status	Description	Recommended Action
Solid yellow	On	Safety input is on.	None.
Off	Off	Safety input is off.	None.
Solid red	Fault	A fault occurred in an input circuit.	Check connected device and wiring.
Flashing red	Fault in other channel	When dual channels are set: a fault occurred in the other channel.	Correct fault in other channel.

(1) Where 'n' indicates the input number.

IMPORTANT The I/O indicators are not lit while the module is being configured.

Table 9 - Output (OUT0 through OUTn⁽¹⁾) Indicators

State	Status	Description	Recommended Action
Solid yellow	On	Safety output is on.	None.
Off	Off	Safety output is off.	None.
Solid red	Fault	A fault occurred in an output circuit.	Check connected device and wiring.
Flashing red	Fault in other channel	When dual channels are set, a fault occurred in the other channel.	Correct fault in other channel.

(1) Where 'n' indicates the output number.

1732DS-IB8XOBV4, 1732DS-IB8, 1791DS-IB8XOBV4, and 1791DS-IB16 Status Indicators

Refer to the tables for information on how to interpret status indicators on the 1732DS-IB8XOBV4, 1732DS-IB8, 1791DS-IB8XOB8, and 1791DS-IB16 modules.

Table 10 - Module Status (MS) Indicator

State	Status	Description	Recommended Action
Off	No power or autobauding	No power is applied to the DeviceNet connector.	Apply power to this connector.
Solid green	Normal operation	The module is operating normally.	None.
Solid red	Unrecoverable fault	The module has detected an unrecoverable fault.	Cycle power to the module. If the anomaly persists, replace the module.
Flashing green	Module needs commissioning due to missing, incomplete, or incorrect configuration	Module is unconfigured.	Reconfigure the module. For additional information, inspect the Network Status (NS) indicator.
Flashing red	Recoverable fault	The module detected a recoverable fault.	Cycle power to the module or reset the module.
	User-initiated firmware update	User-initiated firmware update is in progress.	Wait for the firmware update to complete.
Flashing red and green	Device in self test	The module is performing its power-cycle diagnostic tests.	Wait for the module to complete its power-cycle diagnostics.

Table 11 - Network Status (NS) Indicator

State	Status	Description	Recommended Action
Off	Module not online or no power	The module is not online with the network.	Verify your network.
Flashing green	Module online with no connections in established state	The module identified the communication rate of the network but no connections are established.	Verify your network and module configuration.
Solid green	Module online with connections in established state	The module is operating normally.	None.
Flashing red	One or more I/O connections in timed-out state	The module detected a recoverable network fault.	Verify your network and module configuration.
	User-initiated firmware update	User-initiated firmware update is in progress.	Wait for the firmware update to complete.
Solid red	Critical link failure	The module detected an error that prevents it from communicating on the network.	Cycle power to the module. If the anomaly persists, replace the module.
Flashing red and green	Communication faulted module	The module detected a network access error and is in communication faulted state. The module has received and accepted an Identity Communication Faulted Request-long protocol message.	Verify your network and module configuration.

Table 12 - Configuration Lock (LOCK) Indicator

State	Status	Description	Recommended Action
Off	No configuration	Invalid configuration data.	Provide valid configuration data.
	The configuration is owned by a CIP safety originator, such as GuardLogix software	The configuration is owned by a CIP safety originator, such as GuardLogix software.	None.
Solid yellow	Locked	Valid configuration, locked by a network configuration tool such as RSNetWorx for DeviceNet software.	None.
Flashing yellow	Not locked	Valid configuration, owned by a software configuration tool such as RSNetWorx for DeviceNet software.	None.

Table 13 - 24V DC Input Power Indicator

State	Status	Description	Recommended Action
Off	No power	No power is applied.	Apply power to this section.
Solid green	Normal operation	The applied voltage is within specifications.	None.
Solid yellow	Input power out of specification	The input power is out of specification.	Check your connectors, wiring, and voltages. For additional information, see the applicable installation instructions.

Table 14 - 24V DC Output Power Indicator

State	Status	Description	Recommended Action
Off	No power	No power is applied.	Apply power to this section.
Solid green	Normal operation	The applied voltage is within specifications.	None.
Solid yellow	Output power out of specification	The output power is out of specification.	Check your connectors, wiring, and voltages. For additional information, see the applicable installation instructions.

Table 15 - Safety Input Indicator

State	Status	Description	Recommended Action
Off	Safety input off or module being configured	The safety input is off or the module is being configured.	Turn the safety input on or wait for the module to be configured.
Solid yellow	Safety input on	The safety input is on.	None.
Solid red	Fault detected	A fault in the external wiring or input circuit detected.	Check configuration, field wiring, and devices. If no anomaly is found, replace the module.
Flashing red	Partner fault detected	A fault in the partner input circuit of a dual input configuration detected.	Check the field wiring and verify your configuration for the partner circuit. If no anomaly is found, replace the module.

Table 16 - Safety Output Indicator

State	Status	Description	Recommended Action
Off	Safety output off or module being configured	The safety output is off or the module is being configured.	Turn the safety output on or wait for the module to be configured.
Solid yellow	Safety output on	The safety output is on.	None.
Solid red	Fault detected	A fault in the output circuit was detected.	Check the circuit wiring and end device. If no anomaly is found, replace the module.
		Both tags in a dual channel circuit do not have the same value.	Make sure logic is driving tag values to the same state (off or on).
Flashing red	Partner fault detected	A fault in the partner output circuit of a dual output configuration was detected.	Check the circuit wiring and end device of the partner. If no anomaly is found, replace the module.

Table 17 - Test Output Indicator (1791DS-IB8X0BV4, 1791DS-IB16 only)

State	Status	Description	Recommended Action
Off	Test output off or module being configured	The test output is off or the module is being configured.	Turn the test output on or wait for the module to be configured.
Solid yellow	Output on	Output is on.	None.
Solid red	Fault detected	A fault in the external wiring or input circuit detected.	Check the field wiring. If no anomaly is found, replace the module. Outputs configured for muting could indicate undercurrent or burned-out lamp.

Notes:

Get Point Status from Modules by Using Explicit Messaging

Topic	Page
Considerations for Obtaining Point Status	137
1791DS-IB8X0B8 Module Definition Configuration	138
1791DS-IB4X0W4 Module Definition Configuration	142
I/O Assembly and Reference Data	148
Explicit Messages	155
Basic Format of Explicit Messages	157
Explicit Messages	158

Considerations for Obtaining Point Status

This appendix provides information about how to use explicit messaging to get diagnostic status information from the modules.

To maximize throughput when using DeviceNet safety I/O modules, consider the requested packet interval, baud rate, and the size of the I/O assembly. Keeping the I/O assembly at 2-bytes or fewer does not provide individual point status necessary to quickly diagnose what point faulted from an operator terminal.

To obtain individual point status of the Guard I/O module from the Module Definition dialog box, from the Input Status pull-down menu, choose Pt. Status.

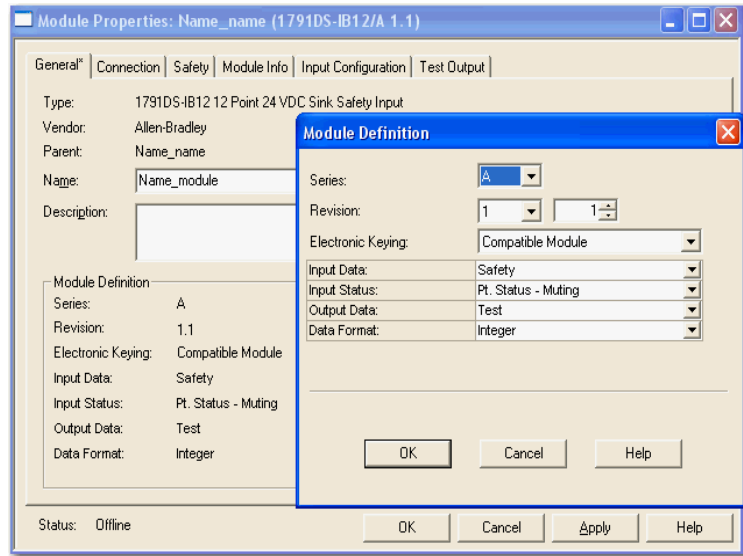

TIP You can also obtain overall status implicitly from this dialog box by choosing Combined Status from the Input Status pull-down menu. If the Combined Status changes, use explicit messaging to obtain the point-level status.

1791DS-IB8XOB8 Module Definition Configuration

Follow this procedure to configure the 1791DS-IB8XOB8 module definition.

1. In the Module Definition dialog box, from the Input Status pull-down menu, choose Combined Status.

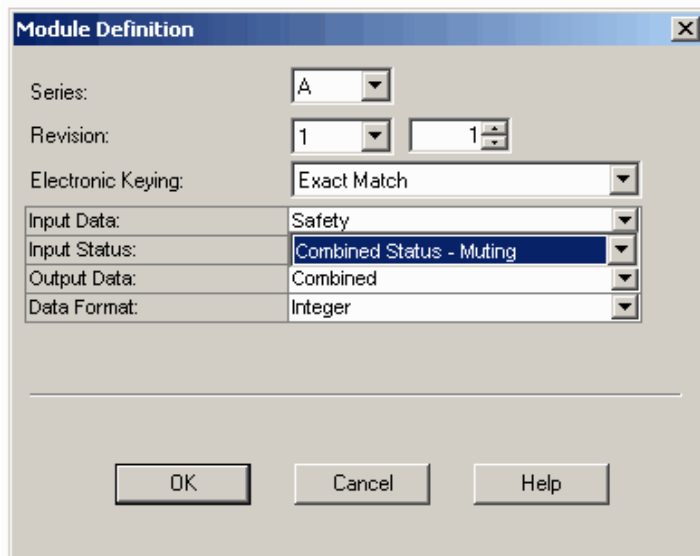

This creates a 2-byte input assembly, as shown for the 1791DS-IB8XOB8 module.

IB8XOB8:I.Pt00Data
IB8XOB8:I.Pt01Data
IB8XOB8:I.Pt02Data
IB8XOB8:I.Pt03Data
IB8XOB8:I.Pt04Data
IB8XOB8:I.Pt05Data
IB8XOB8:I.Pt06Data
IB8XOB8:I.Pt07Data
IB8XOB8:I.OutputStatus
IB8XOB8:I.InputStatus
IB8XOB8:I.MutingStatus

2. Use the InputStatus and OutputStatus bits to detect if one or more of the I/O points on the module have a fault.
 - If any input or output status bit goes to a value of 0 (0=bad, 1=good), use an explicit message to determine which individual data points have faulted. Use the InputState and OutputStatus bits to condition your msg rung as follows.
 - Note that the second rung can be used to read the status on mode transition and once a fault is detected, continue reading until the fault is corrected.
 - Place these rungs in the standard task.

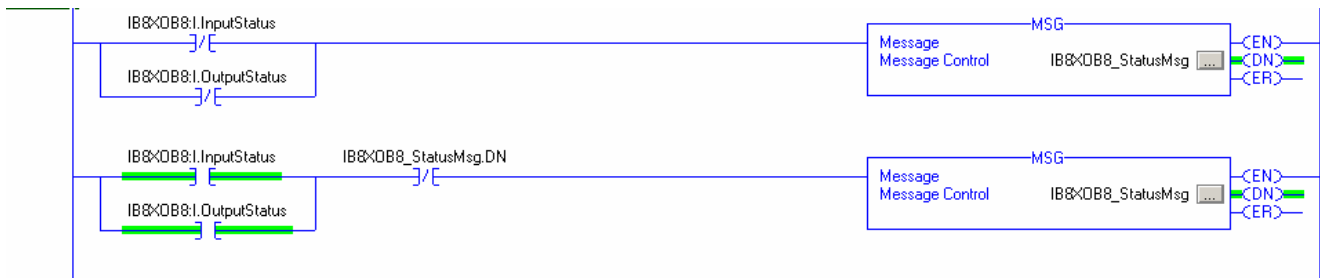

This figure shows the MSG instruction parameters for reading Instance 803 from the 1791DS-IB8XOB8 module.

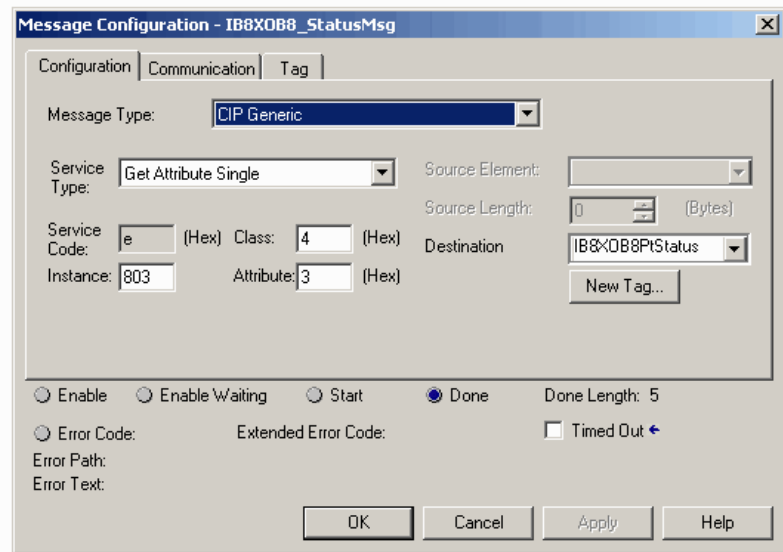

In this example, we created a UDT from the destination type.

- You can find the UDT called Assembly803_1791DS_IB8XOB8 in an ACD file. This UDT is based on the Assembly803 for 1791DS_IB8XOB8 module.
- There are other assemblies in the EDS file that can be used, but this one is the most inclusive.
- Make sure the Communication Path is set to the correct module.

This figure shows the 1791DS-IBXOB8 Assembly803 UDT.

Name: Assembly803_1791DS_IB8xOB8

Description: This UDT is for generic msg to 1791DS-IB8xOB8 service type e; Class 4; Instance 803; Attr 3;

Members: Data Type Size: 8 byte(s)

Name	Data Type	Style	Description
Reserved0	BOOL	Decimal	Do Not Use
Reserved1	BOOL	Decimal	Do Not Use
Reserved2	BOOL	Decimal	Do Not Use
Reserved3	BOOL	Decimal	Do Not Use
Reserved4	BOOL	Decimal	Do Not Use
Reserved5	BOOL	Decimal	Do Not Use
Reserved6	BOOL	Decimal	Do Not Use
Reserved7	BOOL	Decimal	Do Not Use
Safety_Input0_Status	BOOL	Decimal	1 = good 0 = bad
Safety_Input1_Status	BOOL	Decimal	1 = good 0 = bad
Safety_Input2_Status	BOOL	Decimal	1 = good 0 = bad
Safety_Input3_Status	BOOL	Decimal	1 = good 0 = bad
Safety_Input4_Status	BOOL	Decimal	1 = good 0 = bad
Safety_Input5_Status	BOOL	Decimal	1 = good 0 = bad
Safety_Input6_Status	BOOL	Decimal	1 = good 0 = bad
Safety_Input7_Status	BOOL	Decimal	1 = good 0 = bad
Safety_Output0_Status	BOOL	Decimal	1 = good 0 = bad
Safety_Output1_Status	BOOL	Decimal	1 = good 0 = bad
Safety_Output2_Status	BOOL	Decimal	1 = good 0 = bad
Safety_Output3_Status	BOOL	Decimal	1 = good 0 = bad
Safety_Output4_Status	BOOL	Decimal	1 = good 0 = bad
Safety_Output5_Status	BOOL	Decimal	1 = good 0 = bad
Safety_Output6_Status	BOOL	Decimal	1 = good 0 = bad
Safety_Output7_Status	BOOL	Decimal	1 = good 0 = bad
Readback0	BOOL	Decimal	1 = 24v at the output terminal
Readback1	BOOL	Decimal	1 = 24v at the output terminal
Readback2	BOOL	Decimal	1 = 24v at the output terminal
Readback3	BOOL	Decimal	1 = 24v at the output terminal
Readback4	BOOL	Decimal	1 = 24v at the output terminal
Readback5	BOOL	Decimal	1 = 24v at the output terminal
Readback6	BOOL	Decimal	1 = 24v at the output terminal
Readback7	BOOL	Decimal	1 = 24v at the output terminal
TestOutput0_Status	BOOL	Decimal	1 = good 0 = bad
TestOutput1_Status	BOOL	Decimal	1 = good 0 = bad
TestOutput2_Status	BOOL	Decimal	1 = good 0 = bad
TestOutput3_Status	BOOL	Decimal	1 = good 0 = bad
Reserved8	BOOL	Decimal	Not used
Reserved9	BOOL	Decimal	Not used
Reserved10	BOOL	Decimal	Not used
MulingLamp_Status	BOOL	Decimal	1 = good 0 = bad

1791DS-IB4XOW4 Module Definition Configuration

Follow this procedure to configure the 1791DS-IB4XOW4 module definition.

1. In the Module Definition dialog box, from the Input Status pull-down menu, choose Combined Status-Muting.

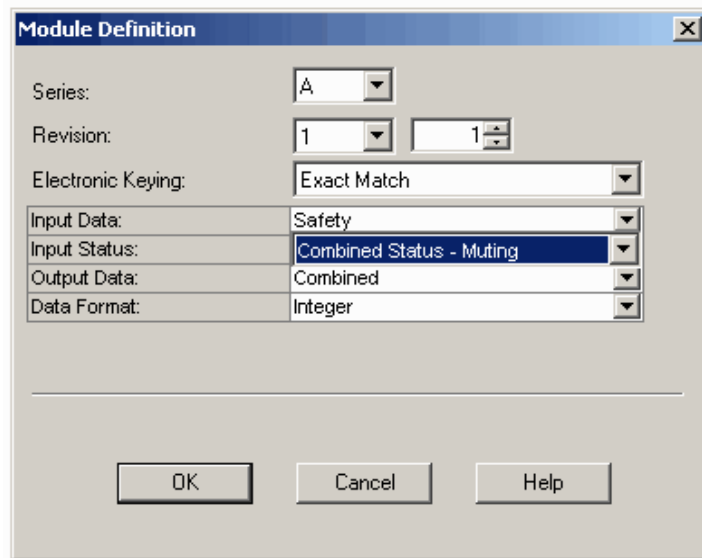

This creates a 1-byte input assembly, as shown for the 1791DS-IB4XOW4 module.

IB4XOW4:I.Pt00Data
IB4XOW4:I.Pt01Data
IB4XOW4:I.Pt02Data
IB4XOW4:I.Pt03Data
IB4XOW4:I.OutputStatus
IB4XOW4:I.InputStatus
IB4XOW4:I.MutingStatus

2. Use the InputStatus and OutputStatus bits to detect if one or more of the I/O points on the module have a fault.
 - If any input or output status bit goes to a value of 0 (0=bad, 1=good), use an explicit message to determine which individual data points have faulted. Use the InputState and OutputStatus bits to condition your msg rung as follows.
 - Note that the second rung can be used to read the status on mode transition and once a fault is detected, continue reading until the fault is corrected.
 - Place these rungs in the standard task.

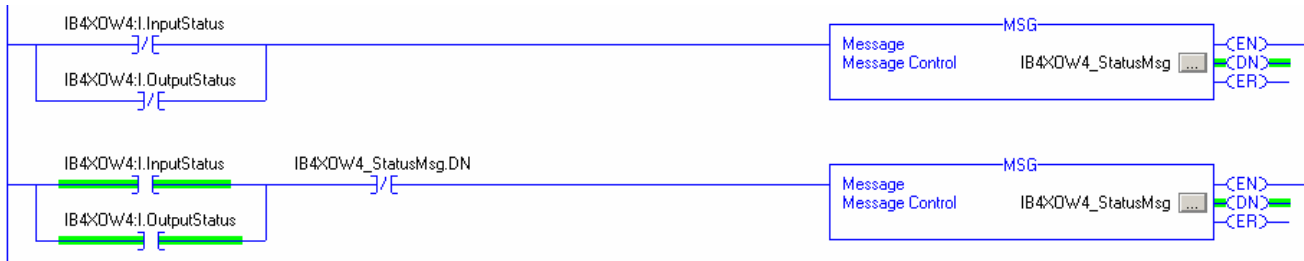

This figure shows the MSG instruction parameters for reading Instance 819 from the 1791DS-IB4XOW4 module.

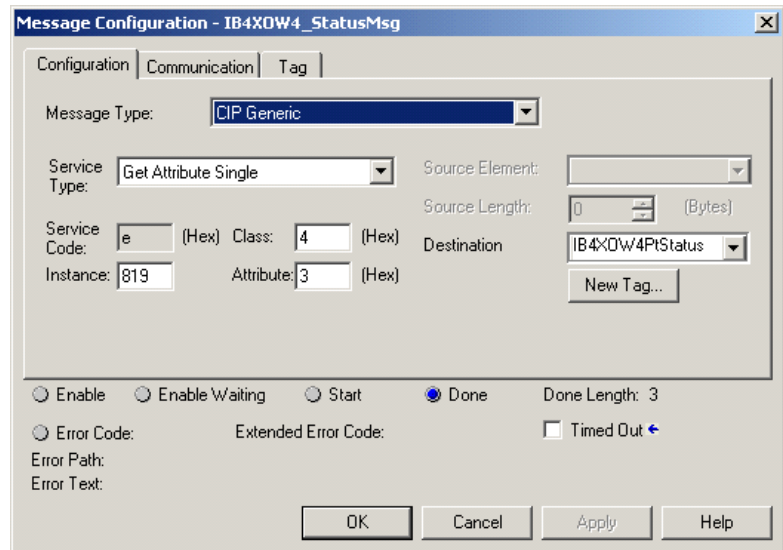

In this example, we created a UDT from the destination type.

- You can find the UDT called Assembly819_1791DS_IB4XOW4 in an ACD file. This UDT is based on the Assembly819 for 1791DS_IB4XOW4 module.
- There are other assemblies in the EDS file that can be used, but this one is the most inclusive.
- Make sure the Communication Path is set to the correct module.

This figure shows the 1791DS-IB4XOW4 Assembly819 UDT.

Name: Assembly819_1791DS_IB4XOW4

Description: This UDT is for generic msg to 1791DS-IB4XOW4 service type e; Class 4; Instance 819; Attr 3;

Members: Data Type Size: 4 byte(s)

Name	Data Type	Style	Description
Reserved0	BOOL	Decimal	Do Not Use
Reserved1	BOOL	Decimal	Do Not Use
Reserved2	BOOL	Decimal	Do Not Use
Reserved3	BOOL	Decimal	Do Not Use
Safety_Input0_Status	BOOL	Decimal	1 good 0 bad
Safety_Input1_Status	BOOL	Decimal	1 good 0 bad
Safety_Input2_Status	BOOL	Decimal	1 good 0 bad
Safety_Input3_Status	BOOL	Decimal	1 good 0 bad
Safety_Output0_Status	BOOL	Decimal	1 good 0 bad
Safety_Output1_Status	BOOL	Decimal	1 good 0 bad
Safety_Output2_Status	BOOL	Decimal	1 good 0 bad
Safety_Output3_Status	BOOL	Decimal	1 good 0 bad
Output0_Readback	BOOL	Decimal	1 = 24v at the terminal point
Output1_Readback	BOOL	Decimal	1 = 24v at the terminal point
Output2_Readback	BOOL	Decimal	1 = 24v at the terminal point
Output3_Readback	BOOL	Decimal	1 = 24v at the terminal point
TestOutput0_Status	BOOL	Decimal	1 = good 0 = bad
TestOutput1_Status	BOOL	Decimal	1 = good 0 = bad
TestOutput2_Status	BOOL	Decimal	1 = good 0 = bad
TestOutput3_Status	BOOL	Decimal	1 = good 0 = bad
Reserved4	BOOL	Decimal	Not used
Reserved5	BOOL	Decimal	Not used
Reserved6	BOOL	Decimal	Not used
MutingLamp_Status	BOOL	Decimal	1 = good 0 = bad

1791DS-IB12 Module Definition Configuration

Follow this procedure to configure the 1791DS-IB12 module definition.

1. In the Module Definition dialog box, from the Input Status pull-down menu, choose Combined Status-Muting.

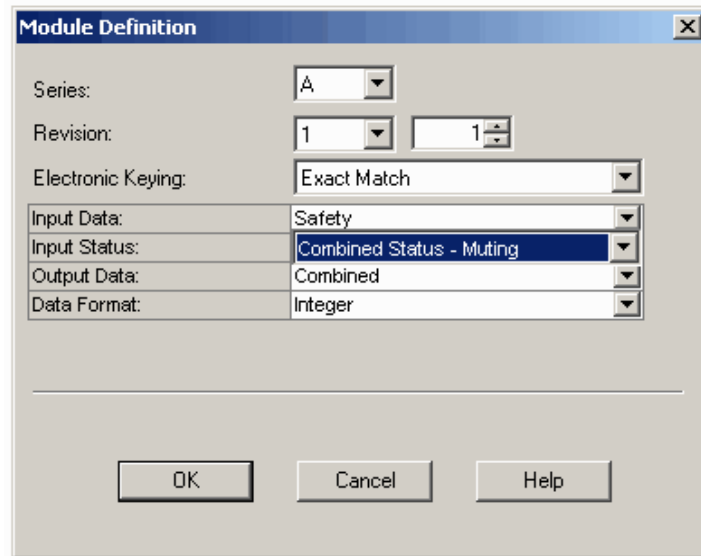

This creates a 2-byte assembly, as shown for the 1791DS-IB12 module.

IB12:I.Pt00Data
IB12:I.Pt01Data
IB12:I.Pt02Data
IB12:I.Pt03Data
IB12:I.Pt04Data
IB12:I.Pt05Data
IB12:I.Pt06Data
IB12:I.Pt07Data
IB12:I.Pt08Data
IB12:I.Pt09Data
IB12:I.Pt10Data
IB12:I.Pt11Data
IB12:I.CombinedStatus
IB12:I.MutingStatus

2. Use the CombinedStatus bit to detect if one or more of the I/O points on the module have a fault.
 - If the CombinedStatus bit goes to a value of 0 (0=bad, 1=good), use an explicit message to determine which individual data points have faulted. Use the CombinedStatus bits to condition your msg rung as follows.
 - Note that you can use the second rung to read the status on mode transition and once a fault is detected, continue reading until the fault is corrected.
 - Place these rungs in the standard task.

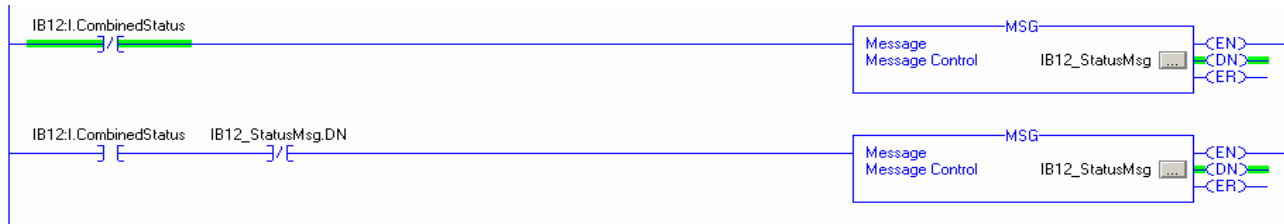

This figure shows the MSG instruction parameters for reading Instance 786 from the 1791DS-IB12 module.

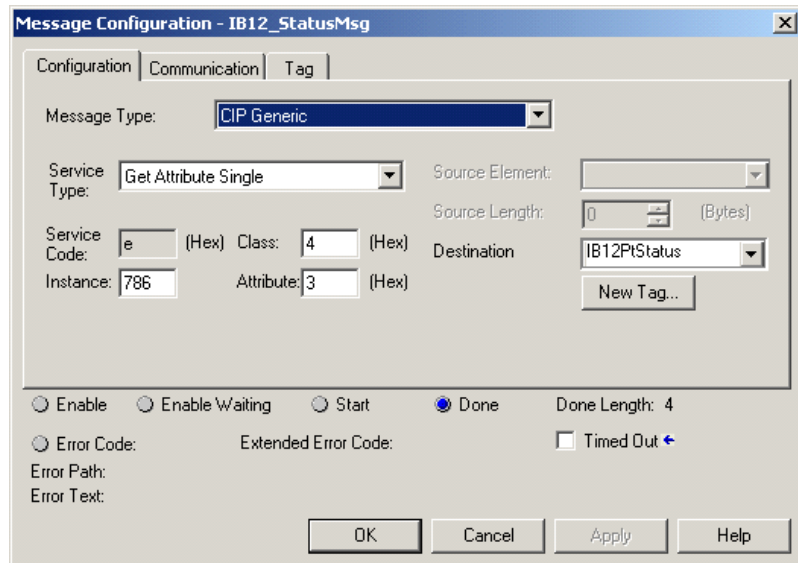

In this example, we created a UDT from the destination type.

- You can find the UDT called Assembly786_1791DS_IB12 in an ACD file. This UDT is based on the Assembly786 for the 1791DS_IB12 module.
- There are other assemblies in the EDS file that can be used, but this one is the most inclusive.
- Make sure the Communication Path is set to the correct module.

This figure shows the 1791DS-IB12 Assembly786 UDT.

Name:

Description:

Members: Data Type Size: 4 byte(s)

Name	Data Type	Style	Description
Reserved0	BOOL	Decimal	Do Not Use
Reserved1	BOOL	Decimal	Do Not Use
Reserved2	BOOL	Decimal	Do Not Use
Reserved3	BOOL	Decimal	Do Not Use
Reserved4	BOOL	Decimal	Do Not Use
Reserved5	BOOL	Decimal	Do Not Use
Reserved6	BOOL	Decimal	Do Not Use
Reserved7	BOOL	Decimal	Do Not Use
Reserved8	BOOL	Decimal	Do Not Use
Reserved9	BOOL	Decimal	Do Not Use
Reserved10	BOOL	Decimal	Do Not Use
Reserved11	BOOL	Decimal	Do Not Use
Safety_Input0_Status	BOOL	Decimal	1 = good 0 = bad
Safety_Input1_Status	BOOL	Decimal	1 = good 0 = bad
Safety_Input2_Status	BOOL	Decimal	1 = good 0 = bad
Safety_Input3_Status	BOOL	Decimal	1 = good 0 = bad
Safety_Input4_Status	BOOL	Decimal	1 = good 0 = bad
Safety_Input5_Status	BOOL	Decimal	1 = good 0 = bad
Safety_Input6_Status	BOOL	Decimal	1 = good 0 = bad
Safety_Input7_Status	BOOL	Decimal	1 = good 0 = bad
Safety_Input8_Status	BOOL	Decimal	1 = good 0 = bad
Safety_Input9_Status	BOOL	Decimal	1 = good 0 = bad
Safety_Input10_Status	BOOL	Decimal	1 = good 0 = bad
Safety_Input11_Status	BOOL	Decimal	1 = good 0 = bad
TestOutput0_Status	BOOL	Decimal	1 = good 0 = bad
TestOutput1_Status	BOOL	Decimal	1 = good 0 = bad
TestOutput2_Status	BOOL	Decimal	1 = good 0 = bad
TestOutput3_Status	BOOL	Decimal	1 = good 0 = bad
Reserved12	BOOL	Decimal	Not used
Reserved13	BOOL	Decimal	Not used
Reserved14	BOOL	Decimal	Not used
MutingLamp_Status	BOOL	Decimal	1 = good 0 = bad

I/O Assembly and Reference Data

See the tables for I/O assembly and reference data.

1791DS-IB12, 1791DS-IB8X0B8, 1791DS-IB4X0W4 Data

The bits in the tag definitions of the Logix Designer application and RSNetWorx for DeviceNet software are different than those shown in this section. This table defines the name associations for clarification with the programming software.

Bit Definitions	Logix Designer Application Tag Name
Safety Input 0	Pt00Data
Safety Input 11	Pt11Data
Safety Input 0 Status	Pt00InputStatus
Safety Input 11 Status	Pt11InputStatus
Safety In Status	InputStatus
Muting Lamp Status	MutingStatus
Safety Output 0	Pt00Data
Safety Output 7	Pt07Data
Standard Output 0	Test00Data
Standard Output 3	Test03Data
Safety Output 0 Status	Pt00OutputStatus
Safety Output 7 Status	Pt07OutputStatus
Safety Out Status	OutputStatus
Safety Output 0 Monitor	Pt00Monitor
Safety Output 7 Monitor	Pt07Readback
Test Output 0 Status	Pt00TestOutputStatus
Test Output 3 Status	Pt03TestOutputStatus

These tables provide reference data concerning input and output data.

Table 18 - Input Data for 1791DS-IB12, 1791DS-IB8X0B8, 1791DS-IB4X0W4 Modules

Instance Hex (decimal)	Module	Byte	Bit 7	Bit 6	Bit 5	Bit 4	Bit 3	Bit 2	Bit 1	Bit 0
203 (515)	1791DS-IB4X0W4	0	Reserved				Safety Input 3	Safety Input 2	Safety Input 1	Safety Input 0
204 (516)	1791DS-IB8X0B8	0	Safety Input 7	Safety Input 6	Safety Input 5	Safety Input 4	Safety Input 3	Safety Input 2	Safety Input 1	Safety Input 0
20C (524)	1791DS-IB12	0	Safety Input 7	Safety Input 6	Safety Input 5	Safety Input 4	Safety Input 3	Safety Input 2	Safety Input 1	Safety Input 0
		1	Reserved				Safety Input 11	Safety Input 10	Safety Input 9	Safety Input 8
224 (548)	1791DS-IB12	0	Safety Input 7	Safety Input 6	Safety Input 5	Safety Input 4	Safety Input 3	Safety Input 2	Safety Input 1	Safety Input 0
		1	Safety Input 7 Status	Safety Input 6 Status	Safety Input 5 Status	Safety Input 4 Status	Safety Input 3 Status	Safety Input 2 Status	Safety Input 1 Status	Safety Input 0 Status
22C (556)	1791DS-IB12	0	Safety Input 7	Safety Input 6	Safety Input 5	Safety Input 4	Safety Input 3	Safety Input 2	Safety Input 1	Safety Input 0
		1	Safety Input 3 Status	Safety Input 2 Status	Safety Input 1 Status	Safety Input 0 Status	Safety Input 11	Safety Input 10	Safety Input 9	Safety Input 8
		2	Safety Input 11 Status	Safety Input 10 Status	Safety Input 9 Status	Safety Input 8 Status	Safety Input 7 Status	Safety Input 7 Status	Safety Input 5 Status	Safety Input 4 Status
300 (768)	1791DS-IB12, 1791DS-IB8X0B8, 1791DS-IB4X0W4	0	Reserved						Output Power Error	Input Power Error
310 (784)	1791DS-IB12	0	Safety Input 7	Safety Input 6	Safety Input 5	Safety Input 4	Safety Input 3	Safety Input 2	Safety Input 1	Safety Input 0
		1	Muting Lamp Status	Combined Safety In Status	Reserved			Safety Input 11	Safety Input 10	Safety Input 9
311 (785)	1791DS-IB12	0	Safety Input 7	Safety Input 6	Safety Input 5	Safety Input 4	Safety Input 3	Safety Input 2	Safety Input 1	Safety Input 0
		1	Safety Input 3 Status	Safety Input 2 Status	Safety Input 1 Status	Safety Input 0 Status	Safety Input 11	Safety Input 10	Safety Input 9	Safety Input 8
		2	Safety Input 11 Status	Safety Input 10 Status	Safety Input 9 Status	Safety Input 8 Status	Safety Input 7 Status	Safety Input 6 Status	Safety Input 5 Status	Safety Input 4 Status
		3	Muting Lamp Status	Reserved						
312 (786)	1791DS-IB12	0	Safety Input 7	Safety Input 6	Safety Input 5	Safety Input 4	Safety Input 3	Safety Input 2	Safety Input 1	Safety Input 0
		1	Safety Input 3 Status	Safety Input 2 Status	Safety Input 1 Status	Safety Input 0 Status	Safety Input 11	Safety Input 10	Safety Input 9	Safety Input 8
		2	Safety Input 11 Status	Safety Input 10 Status	Safety Input 9 Status	Safety Input 8 Status	Safety Input 7 Status	Safety Input 6 Status	Safety Input 5 Status	Safety Input 4 Status
		3	Muting Lamp Status	Reserved				Test Output 3 Status	Test Output 2 Status	Test Output 1 Status
320 (800)	1791DS-IB8X0B8	0	Safety Input 7	Safety Input 6	Safety Input 5	Safety Input 4	Safety Input 3	Safety Input 2	Safety Input 1	Safety Input 0
		1	Muting Lamp Status	Combined Safety In Status	Combined Safety Out Status	Reserved				

Table 18 - Input Data for 1791DS-IB12, 1791DS-IB8XOB8, 1791DS-IB4XOW4 Modules (Continued)

Instance Hex (decimal)	Module	Byte	Bit 7	Bit 6	Bit 5	Bit 4	Bit 3	Bit 2	Bit 1	Bit 0
321 (801)	1791DS-IB8XOB8	0	Safety Input 7	Safety Input 6	Safety Input 5	Safety Input 4	Safety Input 3	Safety Input 2	Safety Input 1	Safety Input 0
		1	Safety Input 7 Status	Safety Input 6 Status	Safety Input 5 Status	Safety Input 4 Status	Safety Input 3 Status	Safety Input 2 Status	Safety Input 1 Status	Safety Input 0 Status
		2	Safety Output 7 Status	Safety Output 6 Status	Safety Output 5 Status	Safety Output 4 Status	Safety Output 3 Status	Safety Output 2 Status	Safety Output 1 Status	Safety Output 0 Status
		3	Muting Lamp Status	Reserved						
322 (802)	1791DS-IB8XOB8	0	Safety Input 7	Safety Input 6	Safety Input 5	Safety Input 4	Safety Input 3	Safety Input 2	Safety Input 1	Safety Input 0
		1	Safety Input 7 Status	Safety Input 6 Status	Safety Input 5 Status	Safety Input 4 Status	Safety Input 3 Status	Safety Input 2 Status	Safety Input 1 Status	Safety Input 0 Status
		2	Safety Output 7 Status	Safety Output 6 Status	Safety Output 5 Status	Safety Output 4 Status	Safety Output 3 Status	Safety Output 2 Status	Safety Output 1 Status	Safety Output 0 Status
		3	Safety Output 7 Readback	Safety Output 6 Readback	Safety Output 5 Readback	Safety Output 4 Readback	Safety Output 3 Readback	Safety Output 2 Readback	Safety Output 1 Readback	Safety Output 0 Readback
		4	Muting Lamp Status	Reserved						
323 (803)	1791DS-IB8XOB8	0	Safety Input 7	Safety Input 6	Safety Input 5	Safety Input 4	Safety Input 3	Safety Input 2	Safety Input 1	Safety Input 0
		1	Safety Input 7 Status	Safety Input 6 Status	Safety Input 5 Status	Safety Input 4 Status	Safety Input 3 Status	Safety Input 2 Status	Safety Input 1 Status	Safety Input 0 Status
		2	Safety Output 7 Status	Safety Output 6 Status	Safety Output 5 Status	Safety Output 4 Status	Safety Output 3 Status	Safety Output 2 Status	Safety Output 1 Status	Safety Output 0 Status
		3	Safety Output 7 Readback	Safety Output 6 Readback	Safety Output 5 Readback	Safety Output 4 Readback	Safety Output 3 Readback	Safety Output 2 Readback	Safety Output 1 Readback	Safety Output 0 Readback
		4	Muting Lamp Status	Reserved				Test Output 3 Status	Test Output 2 Status	Test Output 1 Status
330 (816)	1791DS-IB4XOW4	0	Muting Lamp Status	Combined Safety In Status	Combined Safety Out Status	Reserved	Safety Input 3	Safety Input 2	Safety Input 1	Safety Input 0
331 (817)	1791DS-IB4XOW4	0	Safety Input 3 Status	Safety Input 2 Status	Safety Input 1 Status	Safety Input 0 Status	Safety Input 3	Safety Input 2	Safety Input 1	Safety Input 0
		1	Muting Lamp Status	Reserved				Safety Output 3 Status	Safety Output 2 Status	Safety Output 1 Status
332 (818)	1791DS-IB4XOW4	0	Safety Input 3 Status	Safety Input 2 Status	Safety Input 1 Status	Safety Input 0 Status	Safety Input 3	Safety Input 2	Safety Input 1	Safety Input 0
		1	Safety Output 3 Readback	Safety Output 2 Readback	Safety Output 1 Readback	Safety Output 0 Readback	Safety Output 3 Status	Safety Output 2 Status	Safety Output 1 Status	Safety Output 0 Status
		2	Muting Lamp Status	Reserved						
333 (819)	1791DS-IB4XOW4	0	Safety Input 3 Status	Safety Input 2 Status	Safety Input 1 Status	Safety Input 0 Status	Safety Input 3	Safety Input 2	Safety Input 1	Safety Input 0
		1	Safety Output 3 Readback	Safety Output 2 Readback	Safety Output 1 Readback	Safety Output 0 Readback	Safety Output 3 Status	Safety Output 2 Status	Safety Output 1 Status	Safety Output 0 Status
		2	Muting Lamp Status	Reserved				Test Output 3 Status	Test Output 2 Status	Test Output 1 Status

Table 18 - Input Data for 1791DS-IB12, 1791DS-IB8X0B8, 1791DS-IB4X0W4 Modules (Continued)

Instance Hex (decimal)	Module	Byte	Bit 7	Bit 6	Bit 5	Bit 4	Bit 3	Bit 2	Bit 1	Bit 0
340 (832)	1791DS-IB12	0	Reserved							
		1	Reserved				Test Output 3 Status	Test Output 2 Status	Output Power Error	Input Power Error
341 (833)	1791DS-IB8X0B8	0	Reserved							
		1	Safety Output 7 Readback	Safety Output 6 Readback	Safety Output 5 Readback	Safety Output 4 Readback	Safety Output 3 Readback	Safety Output 2 Readback	Output Power Error	Input Power Error
		2	Reserved				Test Output 3 Status	Test Output 2 Status	Test Output 1 Status	Test Output 0 Status
342 (834)	1791DS-IB4X0W4	0	Reserved							
		1	Test Output 3 Status	Test Output 2 Status	Test Output 1 Status	Test Output 0 Status	Safety Output 3 Readback	Safety Output 2 Readback	Safety Output 1 Readback	Safety Output 0 Readback

Table 19 - Output Data for 1791DS-IB12, 1791DS-IB8X0B8, 1791DS-IB4X0W4 Modules

Instance Hex (decimal)	Module	Byte	Bit 7	Bit 6	Bit 5	Bit 4	Bit 3	Bit 2	Bit 1	Bit 0
21 (33)	1791DS-IB12, 1791DS-IB8X0B8, 1791DS-IB4X0W4	0	Reserved				Standard Output 3	Standard Output 2	Standard Output 1	Standard Output 0
233 (563)	1791DS-IB4X0W4	0	Reserved				Safety Output 3	Safety Output 2	Safety Output 1	Safety Output 0
234 (564)	1791DS-IB8X0B8	0	Safety Output 7	Safety Output 6	Safety Output 5	Safety Output 4	Safety Output 3	Safety Output 2	Safety Output 1	Safety Output 0
350 (848)	1791DS-IB4X0W4	0	Standard Output 3	Standard Output 2	Standard Output 1	Standard Output 0	Safety Output 3	Safety Output 2	Safety Output 1	Safety Output 0
351 (849)	1791DS-IB8X0B8	0	Safety Output 7	Safety Output 6	Safety Output 5	Safety Output 4	Safety Output 3	Safety Output 2	Safety Output 1	Safety Output 0
		1	Reserved				Standard Output 3	Standard Output 2	Standard Output 1	Standard Output 0

1732DS-IB8, 1732DS-IB8XOBV4, 1791DS-IB8XOBV4, and 1791DS-IB16 Data

The bits in the tag definitions of the Logix Designer application and RSNetWorx software are different than those shown in this section. This table defines the name associations for clarification with the programming software.

Bit Definitions	Logix Designer Application Tag Name
Safety Input 0...7	Module Name:I.Pt00Data - Pt15Data
Safety Input 0...7 Status	Module Name:I.Pt00InputStatus - Pt15InputStatus
Combined Safety In Status	Module Name:I.InputStatus
Muting Lamp Status	Module Name:I.MutingStatus
Safety Output 0...7	Module Name:O.Pt00Data - Pt07Data
Safety Output 0...7 Status	Module Name:I.Pt00OutputStatus - Pt07OutputStatus
Combined Safety Out Status	Module Name:I.OutputStatus
Safety Output 0...7 Readback	Module Name:I.Pt00Readback - Pt07Readback
Test Output 0...7 Data	Module Name:I.Test00Data - Test07Data
Test Output 0...7 Status	Module Name:I.Pt00TestOutputStatus - Pt07TestOutputStatus

These tables provide reference data concerning input and output data.

Table 20 - Input Data for 1732DS-IB8, 1732DS-IB8XOBV4, 1791DS-IB8XOBV4, 1791DS-IB16 Modules

Instance Hex (decimal)	Module	Byte	Bit 7	Bit 6	Bit 5	Bit 4	Bit 3	Bit 2	Bit 1	Bit 0	
204 (516)	1732DS-IB8, 1732DS-IB8XOBV4, 1791DS-IB8XOBV4	0	Safety Input 7	Safety Input 6	Safety Input 5	Safety Input 4	Safety Input 3	Safety Input 2	Safety Input 1	Safety Input 0	
224 (548)		0	Safety Input 7	Safety Input 6	Safety Input 5	Safety Input 4	Safety Input 3	Safety Input 2	Safety Input 1	Safety Input 0	
		1	Safety Input 7 Status	Safety Input 6 Status	Safety Input 5 Status	Safety Input 4 Status	Safety Input 3 Status	Safety Input 2 Status	Safety Input 1 Status	Safety Input 0 Status	
205 (517)	1791DS-IB16	0	Safety Input 7	Safety Input 6	Safety Input 5	Safety Input 4	Safety Input 3	Safety Input 2	Safety Input 1	Safety Input 0	
				Safety Input 15	Safety Input 14	Safety Input 13	Safety Input 12	Safety Input 11	Safety Input 10	Safety Input 9	Safety Input 8
225 (549)	1791DS-IB16	0	Safety Input 7	Safety Input 6	Safety Input 5	Safety Input 4	Safety Input 3	Safety Input 2	Safety Input 1	Safety Input 0	
		1	Safety Input 15	Safety Input 14	Safety Input 13	Safety Input 12	Safety Input 11	Safety Input 10	Safety Input 9	Safety Input 8	
		2	Safety Input 7 Status	Safety Input 6 Status	Safety Input 5 Status	Safety Input 4 Status	Safety Input 3 Status	Safety Input 2 Status	Safety Input 1 Status	Safety Input 0 Status	
		3	Safety Input 15 Status	Safety Input 14 Status	Safety Input 13 Status	Safety Input 12 Status	Safety Input 11 Status	Safety Input 10 Status	Safety Input 9 Status	Safety Input 8 Status	
300 (768)	1732DS-IB8, 1791DS-IB16	0	Reserved								Input Power Error
301 (769)	1732DS-IB8, 1732DS-IB8XOBV4, 1791DS-IB8XOBV4	0	Reserved							Output Power Error	Input Power Error
314 (788)	1732DS-IB8	0	Safety Input 7	Safety Input 6	Safety Input 5	Safety Input 4	Safety Input 3	Safety Input 2	Safety Input 1	Safety Input 0	
		1	Reserved							Muting Lamp 7 Status	Muting Lamp 3 Status

Table 20 - Input Data for 1732DS-IB8, 1732DS-IB8XOBV4, 1791DS-IB8XOBV4, 1791DS-IB16 Modules (Continued)

Instance Hex (decimal)	Module	Byte	Bit 7	Bit 6	Bit 5	Bit 4	Bit 3	Bit 2	Bit 1	Bit 0
315 (789)	1791DS-IB16	0	Safety Input 7	Safety Input 6	Safety Input 5	Safety Input 4	Safety Input 3	Safety Input 2	Safety Input 1	Safety Input 0
		1	Safety Input 15	Safety Input 14	Safety Input 13	Safety Input 12	Safety Input 11	Safety Input 10	Safety Input 9	Safety Input 8
		2	Combined Safety In Status	Reserved	Reserved	Reserved	Muting Lamp 15 Status	Muting Lamp 11 Status	Muting Lamp 7 Status	Muting Lamp 3 Status
324 (804)	1732DS-IB8XOBV4, 1791DS-IB8XOBV4	0	Safety Input 7	Safety Input 6	Safety Input 5	Safety Input 4	Safety Input 3	Safety Input 2	Safety Input 1	Safety Input 0
		1	Combined Safety In Status	Combined Safety Out Status	Reserved					Muting Lamp 7 Status
334 (820)	1732DS-IB8, 1732DS-IB8XOBV4, 1791DS-IB8XOBV4	0	Safety Input 7	Safety Input 6	Safety Input 5	Safety Input 4	Safety Input 3	Safety Input 2	Safety Input 1	Safety Input 0
		1	Safety Input 7 Status	Safety Input 6 Status	Safety Input 5 Status	Safety Input 4 Status	Safety Input 3 Status	Safety Input 2 Status	Safety Input 1 Status	Safety Input 0 Status
		2	Reserved							Muting Lamp 7 Status
335 (821)	1791DS-IB16	0	Safety Input 7	Safety Input 6	Safety Input 5	Safety Input 4	Safety Input 3	Safety Input 2	Safety Input 1	Safety Input 0
		1	Safety Input 15	Safety Input 14	Safety Input 13	Safety Input 12	Safety Input 11	Safety Input 10	Safety Input 9	Safety Input 8
		2	Safety Input 7 Status	Safety Input 6 Status	Safety Input 5 Status	Safety Input 4 Status	Safety Input 3 Status	Safety Input 2 Status	Safety Input 1 Status	Safety Input 0 Status
		3	Safety Input 15 Status	Safety Input 14 Status	Safety Input 13 Status	Safety Input 12 Status	Safety Input 11 Status	Safety Input 10 Status	Safety Input 9 Status	Safety Input 8 Status
		4	Reserved	Reserved	Reserved	Reserved	Muting Lamp 15 Status	Muting Lamp 11 Status	Muting Lamp 7 Status	Muting Lamp 3 Status
344 (836)	1732DS-IB8XOBV4, 1791DS-IB8XOBV4	0	Safety Input 7	Safety Input 6	Safety Input 5	Safety Input 4	Safety Input 3	Safety Input 2	Safety Input 1	Safety Input 0
		1	Safety Input 7 Status	Safety Input 6 Status	Safety Input 5 Status	Safety Input 4 Status	Safety Input 3 Status	Safety Input 2 Status	Safety Input 1 Status	Safety Input 0 Status
		2	Safety Output 7 Status	Safety Output 6 Status	Safety Output 5 Status	Safety Output 4 Status	Safety Output 3 Status	Safety Output 2 Status	Safety Output 1 Status	Safety Output 0 Status
		3	Reserved							Muting Lamp 7 Status
354 (852)		0	Safety Input 7	Safety Input 6	Safety Input 5	Safety Input 4	Safety Input 3	Safety Input 2	Safety Input 1	Safety Input 0
		1	Safety Input 7 Status	Safety Input 6 Status	Safety Input 5 Status	Safety Input 4 Status	Safety Input 3 Status	Safety Input 2 Status	Safety Input 1 Status	Safety Input 0 Status
		2	Safety Output 7 Status	Safety Output 6 Status	Safety Output 5 Status	Safety Output 4 Status	Safety Output 3 Status	Safety Output 2 Status	Safety Output 1 Status	Safety Output 0 Status
		3	Safety Output 7 Readback	Safety Output 6 Readback	Safety Output 5 Readback	Safety Output 4 Readback	Safety Output 3 Readback	Safety Output 2 Readback	Safety Output 1 Readback	Safety Output 0 Readback
		4	Reserved							Muting Lamp 7 Status

Table 20 - Input Data for 1732DS-IB8, 1732DS-IB8XOBV4, 1791DS-IB8XOBV4, 1791DS-IB16 Modules (Continued)

Instance Hex (decimal)	Module	Byte	Bit 7	Bit 6	Bit 5	Bit 4	Bit 3	Bit 2	Bit 1	Bit 0	
364 (868)	1732DS-IB8, 1732DS-IB8XOBV4, 1791DS-IB8XOBV4	0	Safety Input 7	Safety Input 6	Safety Input 5	Safety Input 4	Safety Input 3	Safety Input 2	Safety Input 1	Safety Input 0	
		1	Safety Input 7 Status	Safety Input 6 Status	Safety Input 5 Status	Safety Input 4 Status	Safety Input 3 Status	Safety Input 2 Status	Safety Input 1 Status	Safety Input 0 Status	
		2	Test Output 7 Status	Test Output 6 Status	Test Output 5 Status	Test Output 4 Status	Test Output 3 Status	Test Output 2 Status	Test Output 1 Status	Test Output 0 Status	
		3	Reserved							Muting Lamp 7 Status	Muting Lamp 3 Status
365 (869)	1791DS-IB16	0	Standard Output 7	Standard Output 6	Standard Output 5	Standard Output 4	Standard Output 3	Standard Output 2	Standard Output 1	Standard Output 0	
		1	Standard Output 15	Standard Output 14	Standard Output 13	Standard Output 12	Standard Output 11	Standard Output 10	Standard Output 9	Standard Output 8	
		2	Safety Input 7 Status	Safety Input 6 Status	Safety Input 5 Status	Safety Input 4 Status	Safety Input 3 Status	Safety Input 2 Status	Safety Input 1 Status	Safety Input 0 Status	
		3	Safety Input 15 Status	Safety Input 14 Status	Safety Input 13 Status	Safety Input 12 Status	Safety Input 11 Status	Safety Input 10 Status	Safety Input 9 Status	Safety Input 8 Status	
		4	Test Output 7 Status	Test Output 6 Status	Test Output 5 Status	Test Output 4 Status	Test Output 3 Status	Test Output 2 Status	Test Output 1 Status	Test Output 0 Status	
		5	Test Output 15 Status	Test Output 14 Status	Test Output 13 Status	Test Output 12 Status	Test Output 11 Status	Test Output 10 Status	Test Output 9 Status	Test Output 8 Status	
		6	Reserved	Reserved	Reserved	Reserved	Muting Lamp 15 Status	Muting Lamp 11 Status	Muting Lamp 7 Status	Muting Lamp 3 Status	
374 (884)	1732DS-IB8XOBV4, 1791DS-IB8XOBV4	0	Safety Input 7	Safety Input 6	Safety Input 5	Safety Input 4	Safety Input 3	Safety Input 2	Safety Input 1	Safety Input 0	
		1	Safety Input 7 Status	Safety Input 6 Status	Safety Input 5 Status	Safety Input 4 Status	Safety Input 3 Status	Safety Input 2 Status	Safety Input 1 Status	Safety Input 0 Status	
		2	Safety Output 7 Status	Safety Output 6 Status	Safety Output 5 Status	Safety Output 4 Status	Safety Output 3 Status	Safety Output 2 Status	Safety Output 1 Status	Safety Output 0 Status	
		3	Safety Output 7 Readback	Safety Output 6 Readback	Safety Output 5 Readback	Safety Output 4 Readback	Safety Output 3 Readback	Safety Output 2 Readback	Safety Output 1 Readback	Safety Output 0 Readback	
		4	Test Output 7 Status	Test Output 6 Status	Test Output 5 Status	Test Output 4 Status	Test Output 3 Status	Test Output 2 Status	Test Output 1 Status	Test Output 0 Status	
		5	Reserved							Muting Lamp 7 Status	Muting Lamp 3 Status
384 (900)	1732DS-IB8	0	Reserved								Input Power Error
		1	Test Output 7 Status	Test Output 6 Status	Test Output 5 Status	Test Output 4 Status	Test Output 3 Status	Test Output 2 Status	Test Output 1 Status	Test Output 0 Status	
385 (901)	1791DS-IB16	0	Reserved								Input Power Error
		1	Test Output 7 Status	Test Output 6 Status	Test Output 5 Status	Test Output 4 Status	Test Output 3 Status	Test Output 2 Status	Test Output 1 Status	Test Output 0 Status	
		2	Test Output 15 Status	Test Output 14 Status	Test Output 13 Status	Test Output 12 Status	Test Output 11 Status	Test Output 10 Status	Test Output 9 Status	Test Output 8 Status	

Table 20 - Input Data for 1732DS-IB8, 1732DS-IB8XOBV4, 1791DS-IB8XOBV4, 1791DS-IB16 Modules (Continued)

Instance Hex (decimal)	Module	Byte	Bit 7	Bit 6	Bit 5	Bit 4	Bit 3	Bit 2	Bit 1	Bit 0
394 (916)	1732DS-IB8XOBV4, 1791DS-IB8XOBV4	0	Reserved						Output Power Error	Input Power Error
		1	Test Output 7 Status	Test Output 6 Status	Test Output 5 Status	Test Output 4 Status	Test Output 3 Status	Test Output 2 Status	Test Output 1 Status	Test Output 0 Status
3A4 (932)		0	Reserved						Output Power Error	Input Power Error
		1	Safety Output 7 Readback	Safety Output 6 Readback	Safety Output 5 Readback	Safety Output 4 Readback	Safety Output 3 Readback	Safety Output 2 Readback	Safety Output 1 Readback	Safety Output 0 Readback
2		Test Output 7 Status	Test Output 6 Status	Test Output 5 Status	Test Output 4 Status	Test Output 3 Status	Test Output 2 Status	Test Output 1 Status	Test Output 0 Status	

Table 21 - Output Data for 1791DS-IB8XOBV4, 1732DS-IB8, 1732-IB8XOBV4 Modules

Instance Hex (decimal)	Module	Byte	Bit 7	Bit 6	Bit 5	Bit 4	Bit 3	Bit 2	Bit 1	Bit 0
22 (34)	1791DS-IB8XOBV4, 1732DS-IB8, 1732-IB8XOBV4	0	Standard Output 7	Standard Output 6	Standard Output 5	Standard Output 4	Standard Output 3	Standard Output 2	Standard Output 1	Standard Output 0
23 (35)	1791DS-IB16	0	Standard Output 7	Standard Output 6	Standard Output 5	Standard Output 4	Standard Output 3	Standard Output 2	Standard Output 1	Standard Output 0
		1	Standard Output 15	Standard Output 14	Standard Output 13	Standard Output 12	Standard Output 11	Standard Output 10	Standard Output 9	Standard Output 8
234 (564)	1791DS-IB8XOBV4, 1732-IB8XOBV4	0	Safety Output 7	Safety Output 6	Safety Output 5	Safety Output 4	Safety Output 3	Safety Output 2	Safety Output 1	Safety Output 0
2C4 (708)	1791DS-IB8XOBV4, 1732-IB8XOBV4	0	Safety Output 7	Safety Output 6	Safety Output 5	Safety Output 4	Safety Output 3	Safety Output 2	Safety Output 1	Safety Output 0
		1	Standard Output 7	Standard Output 6	Standard Output 5	Standard Output 4	Standard Output 3	Standard Output 2	Standard Output 1	Standard Output 0

Explicit Messages

Table 22 - Reading the Cause of the Safety Input Error

Explicit Message	Read/Write	Function	Command (hex)					Response (hex)
			Service Code	Class ID	Instance ID	Attribute ID	Data Size	
Safety Input Cause of Error Information Read	Read	Reads the cause for the status bit (1...n) specified by the Instance ID turning OFF.	0E	3D	01...n	6E	-	0: No error 01: Configuration invalid 02: External test signal error 03: Internal input error 04: Discrepancy error 05: Error in the other dual channel input

Table 23 - Reading the Cause of the Safety Output Error

Explicit Message	Read/Write	Function	Command (hex)					Response (hex)
			Service Code	Class ID	Instance ID	Attribute ID	Data Size	
Safety Output Cause of Error (Fault) Information	Read	Reads the cause for the status bit (1...n) specified by the Instance ID turning OFF.	0E	3B	01...n	6E	-	0: No error 01: Configuration invalid 02: Over current detected 03: Short circuit detected 04: Output ON error 05: Error in the other dual-channel output 06: Internal-relay output circuit error (replace module) 07: Relay failure (replace relay) 08: Dual-channel violation 09: Short circuit detected at safety output

Table 24 - Monitoring the Test Output Point

Explicit Message	Read/Write	Function	Command (hex)					Response (hex)
			Service Code	Class ID	Instance ID	Attribute ID	Data Size	
Test Output Cause of Error (Fault) Information	Read	Reads the cause for the status bit (1...n) specified by the Instance ID turning OFF.	0E	09	01...n	76	-	0 = No error 01: Configuration invalid 02: Overload detected 03: Cross circuit detected 05: Output ON error 06: Undercurrent detected for muting lamp

Table 25 - Setting Hold/Clear for Communication Errors (Test Output)

Explicit Message	Read/Write	Function	Command (hex)					Response (hex)
			Service Code	Class ID	Instance ID	Attribute ID	Data Size	
Setting for Output Status (Hold or Clear) after Communication Error	Read	Reads whether hold or clear is set as the output status after a communication error for an output specified by the instance ID. The setting can be read for a specified number of points.	0E	09	01...08	05	-	1 byte 00: Clear 01: Hold
Setting for Output Status (Hold or Clear) after Communication Error	Write	Sets whether hold or clear as the output status after a communication error for an output specified by the instance ID. The setting can be read for a specified number of points.	10	09	01...08	05	1 byte 00: Clear 01: Hold	

Basic Format of Explicit Messages

The basic format of each command and response is as follows.

Table 26 - Command Block

Destination Node Address	Service Code	Class ID	Instance ID	Attribute ID	Data
--------------------------	--------------	----------	-------------	--------------	------

- Destination Node Address - The node address of the module that is sending the explicit messages is specified with a 1 byte hexadecimal.
- Service Code, Class ID, Instance ID, Attribute ID - The parameters used for specifying the command, processing object, and processing content.
- Data - Data is not required when the read command is used.

Table 27 - Normal Response Block

Number of Bytes Received	Source Node Address	Service Code	Data
--------------------------	---------------------	--------------	------

Table 28 - Error Response Block

Number of Bytes Received 0004 hex (fixed)	Source Node Address	Service Code	Error Code
---	---------------------	--------------	------------

- Number of Bytes Received - The number of bytes received from the source node address is returned in hexadecimal. When an error response is returned for an explicit message, the number of bytes is always 0004 hex.
- Source Node Address - The node address of the node from which the command was sent is returned in hexadecimal.
- Service Code - For normal completions, the service code specified in the command with the leftmost bit turned ON is stored as shown in the [See Function, Command Service Code, and Response Service Code on page 157](#).

Table 29 - Function, Command Service Code, and Response Service Code

Function	Command Service Code (hex)	Response Service Code (hex)
Read Data	10	90
Write Data	0E	8E
Reset	05	85
Save	16	96

When an error response is returned for an explicit message, the value is always 94 hex.

- Data - Read data is included only when a read command is executed.
- Error code - The explicit message error code

Table 30 - Error Codes

Response Code (hex)	Error Name	Cause
08FF	Service not supported	The service code is incorrect.
09FF	Invalid attribute value	The specified attribute value is not supported. The data written was outside valid range.
16FF	Object does not exist	The specified instance ID is not supported.
15FF	Too much data	The data is larger than the specified size.
13FF	Not enough data	The data is smaller than the specified size.
0CFF	Object state conflict	The specified command cannot be executed due to an internal error.
20FF	Invalid parameter	The specified operation command data is not supported.
0EFF	Attribute is not settable	An attribute ID supported only for reading has been executed for a write service code.
10FF	Device state conflict	The specified command cannot be executed due to an internal error.
14FF	Attribute not supported	The specified attribute is not supported.
19FF	Store operation failure	The data cannot be stored in memory.
2AFF	Group 2 only server general failure	The specified command or attribute is not supported or the attribute was not set.

Explicit Messages

Table 31 - Reading General Status

Explicit Message	Read/Write	Function	Command (hex)					Response
			Service Code	Class ID	Instance ID	Attribute ID	Data Size	
General Status Read	Read	Read the specified Slave's status flags (8 bits).	0E	95	01	65	-	1 byte Bit 0: Input power error Bit 1: Output power error Bit 2...7: Reserved

Table 32 - Setting and Monitoring a Safety Input

Explicit Message	Read/Write	Function	Command (hex)					Response (hex)
			Service Code	Class ID	Instance ID	Attribute ID	Data Size	
Safety Input Cause of Error Information Read	Read	Reads the cause for the normal flag (1...12) specified by the Instance ID turning OFF.	0E	3D	01...0C	6E	-	0: No error 01: Configuration invalid 02: External test signal error 03: Internal input error 04: Discrepancy error 05: Error in the other dual channel input

Table 33 - Setting a Safety Output

Explicit Message	Read/Write	Function	Command (hex)					Response (hex)
			Service Code	Class ID	Instance ID	Attribute ID	Data Size	
Safety Output Cause of Error (Fault) Information	Read	Reads the cause for the normal flag (1...8) specified by the Instance ID turning OFF.	0E	3B	01...08	6E	-	0: No error 01: Configuration invalid 02: Over current detected 03: Short circuit detected 04: Output ON error 05: Error in the other dual channel output 06: Internal-relay output circuit error (replace module) 07: Relay failure (replace relay) 08: Dual channel violation 09: Short circuit detected at safety output

Table 34 - Monitoring the Test Output Point

Explicit Message	Read/Write	Function	Command (hex)					Response (hex)
			Service Code	Class ID	Instance ID	Attribute ID	Data Size	
Safety Output Cause of Error (Fault) Information	Read	Reads the cause for the normal flag (1...8) specified by the Instance ID turning OFF.	0E	09	01...04	6E	-	0 = No error 01: Configuration invalid 02: Overload detected 03: Cross circuit detected 05: Output ON error 06: Undercurrent detected for muting lamp

Table 35 - Setting Hold/Clear for Communication Errors (Test Output)

Explicit Message	Read/Write	Function	Command (hex)					Response (hex)
			Service Code	Class ID	Instance ID	Attribute ID	Data Size	
Setting for Output Status (Hold or Clear) after Communication Error	Read	Reads whether hold or clear is set as the output status after a communication error for an output specified by the instance ID. The setting can be read for a specified number of points.	0E	09	01...08	05	-	1 byte 00: Clear 01: Hold
Setting for Output Status (Hold or Clear) after Communication Error	Write	Sets whether hold or clear as the output status after a communication error for an output specified by the instance ID. The setting can be read for a specified number of points.	10	09	01...08	05	1 byte 00: Clear 01: Hold	-

Notes:

Safety Data

This appendix lists calculated values for probability of failure on demand (PFD), probability of failure per hour (PFH), and mean time between failures. PFD and PFH calculations comply with IEC61508, edition 2, 2010.

Calculated values of probability of failure on demand and probability of failure per hour appear in [Table 36](#) and [Table 37](#) and must be calculated for the devices within the system to comply with the SIL level required for application.

You must be responsible for following the requirements of ISO 13849-1:2008, to assess performance levels in your safety system.

Within the proof test interval, every I/O module must be functionally tested by individually toggling each input point and verifying that each point is detected by the controller.

Additionally, each output point must be individually toggled by the controller and you must verify that the output point changes state.

For more information, refer to these publications.

Resource	Description
GuardLogix 5570 Controller Systems Safety Reference Manual, publication 1756-RM099	Provides information on safety application requirements for GuardLogix 5570 controllers in Studio 5000 Logix Designer projects.
GuardLogix Controller Systems Safety Reference Manual, publication 1756-RM093	Provides information on safety application requirements for GuardLogix 5560 and 5570 controllers in RSLogix 5000 projects.

Figure 30 - PFD versus Proof Test Interval 1791DS-IB8X0BV4, 1732DS-IB8X0BV4

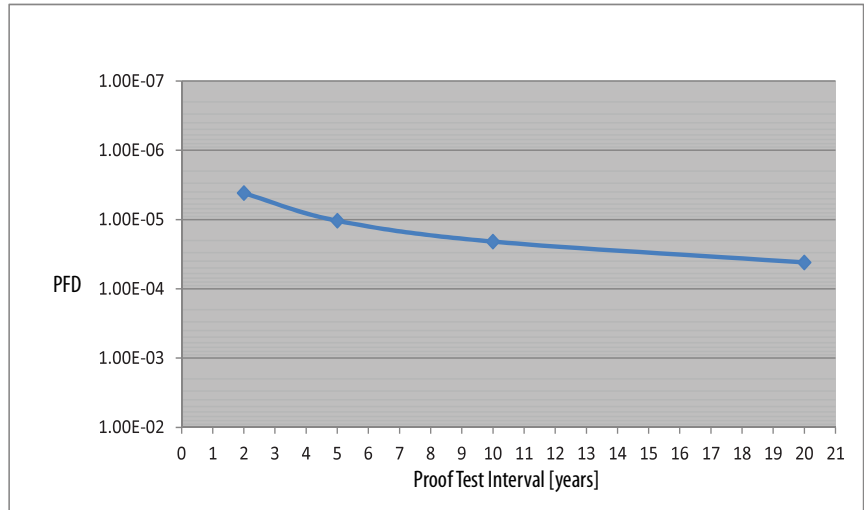

Figure 31 - PFD versus Proof Test Interval 1791DS-IB12, 1791DS-IB8X0B8, 1791DS-IB4X0W4

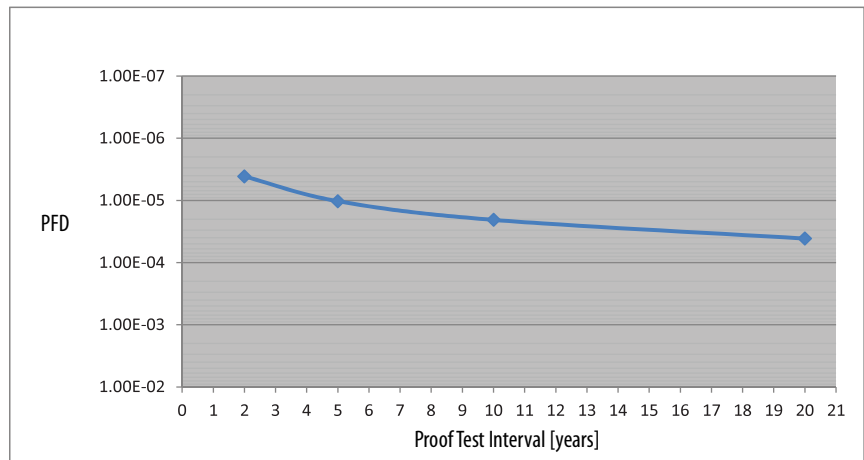

Table 36 - Probability of Failure Data (IEC 61508, Edition 2, 2010)

Cat. No.	Description	Calculated PFD				PFH (1/hour)	Spurious Trip Rate (SPR)	MTTF (years)
		2 Years (17,520 hours)	5 Years (43,800 hours)	10 Years (87,600 hours)	20 Years (175,200 hours)			
1791DS-IB8XOBV4	CIP Safety 8-point input/4 bi-polar output module	4.16E-06	1.04E-05	2.08E-05	4.16E-05	5.02E-10	5.608E-06	20.34
1791DS-IB16	CIP Safety 16-point input module	4.11E-06	1.03E-05	2.06E-05	4.11E-05	4.96E-10	3.301E-06	34.56
1732DS-IB8XOBV4	CIP Safety 8-point input/4 bi-polar output module	4.16E-06	1.04E-05	2.08E-05	4.16E-05	5.02E-10	5.608E-06	20.34
1732DS-IB8	CIP Safety 8-point input module	4.11E-06	1.03E-05	2.06E-05	4.11E-05	4.96E-10	3.301E-06	34.56

Table 37 - Probability of Failure Data (IEC 61508, Edition 1, 1999)

Cat. No.	Description	Calculated PFD				PFH (1/hour) ⁽¹⁾
		2 Years (17,520 hours)	5 Years (43,800 hours)	10 Years (87,600 hours)	20 Years ⁽¹⁾ (175,200 hours)	
1791DS-IB12	CIP Safety 12-point input module	1.754E-06	4.419E-06	8.962E-06	6.013E-06	6.84E-11
1791DS-IB8XOB8	CIP Safety 8-point input/8-point output module	1.755E-06	4.421E-06	8.963E-06	6.013E-06	6.84E-11
1791DS-IB4XOW4	CIP Safety 4-point input/4-point relay output module	4.151E-05	1.207E-04	2.978E-04	7.684E-04	4.072E-09

(1) The 20-year PFD data for this product applies only to product with a manufacture date code of 2009/01/01 (January 1, 2009) or later. See the product label for the date code.

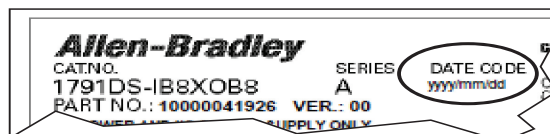

Notes:

Configuration Reference Information

Topic	Page
Understanding Parameter Groups	165
Allocate Remote I/O	167
I/O Data Supported by Each Module	167

Understanding Parameter Groups

The modules have these parameter groups:

- [General Parameters](#)
- [Safety Input Parameters](#)
- [Test Output Parameters](#)
- [Safety Output Parameters](#)

Set all parameters by using the Logix Designer application or RSNetWorx for DeviceNet software.

Table 38 - General Parameters

Parameter Name	Value	Description	Default
Safety Output Error Latch Time	0...65,530 ms (in increments of 10 ms)	Safety output errors are latched for this time.	1000 ms
Safety Input Error Latch Time	0...65,530 ms (in increments of 10 ms)	Safety input or test output errors are latched for this time.	1000 ms
Test Output Idle State	Clear OFF or Keep Output Data	Definition of output data is in idle state.	Clear OFF

Table 39 - Safety Input Parameters

Parameter Name	Value	Description
Input Point Operation Type	Single Channel	Use as single channel.
	Dual-channel Equivalent	Use as dual-channel. Normal when both channels are ON or OFF.
	Dual-channel Complementary	Use as dual-channel. Normal when one channel is ON and the other channel is OFF.
Input Point Mode	Not Used	External input device is not connected.
	Safety Test Pulse	Use with a contact output device and in combination with a test output. By using this setting, short-circuits between input signal lines and the power supply (positive side) and short-circuits between input signal lines can be detected.
	Safety	A solid-state output safety sensor is connected.
	Standard	A standard device, such as a reset switch, is connected.
Safety Input Test Source	Not Used	The test output that is used with the input.
	Test Output 0	
	Test Output 1	
	Test Output 2	
	Test Output 3	
Input Delay Time Off -> On	0...126 ms (in increments of 6 ms)	Filter time for OFF to ON transition.
Input Delay Time On -> Off	0...126 ms (in increments of 6 ms)	Filter time for ON to OFF transition.

IMPORTANT

If the test pulse from test output is set to the Safety Input Channel mode, the safety-input test source and pulse test output of the test output must be set to the Test Output mode.

Table 40 - Test Output Parameters

Parameter Name	Value	Description	Default
Test Output Mode	Not Used	An external device is not connected.	Not Used
	Standard	The output is connected to a standard device.	
	Pulse Test	A contact output device is connected. Use in combination with a safety input.	
	Power Supply	The power supply of a Safety Sensor is connected. The voltage supplied to I/O power (V, G) is output from the test output terminal.	
	Muting Lamp Output (Terminal T3 or T7 only)	An indicator is connected and turned ON to detect broken lines in an external indicator.	
Test Output Fault Action ⁽¹⁾	Clear OFF	Action to perform when a communication error is detected.	Clear OFF
	Hold Last Data		

(1) Not directly related to safety.

Table 41 - Safety Output Parameters

Parameter Name	Value	Description	Default
Output Point Mode	Not Used	An external output devices is not connected.	Not Used
	Safety	When the output is ON, the test pulse is not output (remains ON).	
	Safety Pulse Test	By using this function, short-circuits between output signal lines and the power supply (positive side) and short-circuits between output signal lines can be detected.	
Output Point Operation Type	Single Channel	Use as single channel.	Dual-channel
	Dual-channel	Use as dual-channel. When both channels are normal, outputs can be turned ON.	

Allocate Remote I/O

The module internally stores I/O allocation data. Use the Logix Designer application or RSNetWorx for DeviceNet software to set the connection paths for the allocation of I/O data in the master unit. No settings are made by default. Be sure to set the required connection paths.

The module stores this I/O data:

- SAFETY: Information the controller can use in safety-related functions
- STANDARD: Additional information that must not be relied on for safety functions

I/O Data Supported by Each Module

These tables show the I/O data supported by each module. Refer to I/O Assembly Data for data arrangements.

You can allocate up to four items of I/O-data safety connections, including one output, and up to two items of I/O-data standard connections for the master unit (such as a scanner).

Table 42 - 1791DS-IB12 Modules

Safety Connection	Standard Connection	Configuration Software Setting (see module definition ⁽¹⁾)	Assembly Instance No.	Inputs								Outputs		
				Safety Input Data	Combined Safety Input Status	Individual Safety Input Status	Combined Safety Output Status	Individual Safety Output Status	Muting Lamp Status	Safety Output Readback	Individual Test Output Status	Safety Output Data	Standard Output Data	
•	•	Safety	20C	•										
•	•	Small Safety - Point Status	224	•		•								
•	•	Safety - Point Status	22C	•		•								
•	•	Safety - Combined Status - Muting Status	310	•	•				•					
		Safety - Point Status - Muting Status	311	•		•			•					
•	•	Safety - Point Status - Muting Status - Test Output Status	312	•		•			•		•			
	•	Test	21											•
	•	Test Output Status with General Status Assembly	340								•			

(1) Found in the Logix Designer application, I/O Module Properties, General tab.

Table 43 - 1791DS-IB8X0B8 Modules

Safety Connection	Standard Connection	Configuration Software Setting (see Module Definition ⁽¹⁾)	Assembly Instance No.	Inputs								Outputs		
				Safety Input Data	Combined Safety Input Status	Individual Safety Input Status	Combined Safety Output Status	Individual Safety Output Status	Muting Lamp Status	Safety Output Readback	Individual Test Output Status	Safety Output Data	Standard Output Data	
•	•	Safety	204	•										
•	•	Safety - Combined Status - Muting Status	320	•	•		•		•					
•	•	Safety - Point Status - Muting Status	321	•		•		•	•					
•	•	Safety - Readback - Point Status - Muting Status	322	•		•		•	•	•				
•	•	Safety - Readback - Point Status - Muting Status - Test Output Status	323	•		•		•	•	•	•			
	•	Test	21										•	
•		Safety	234										•	
•		Combined	351										•	•
	•	Output Readback/Test Output Status with General Status Assembly	341							•	•			

(1) Found in the Logix Designer application, I/O Module Properties, General tab.

Table 44 - 1791DS-IB4X0W4 Modules

Safety Connection	Standard Connection	Configuration Software Setting (see Module Definition ⁽¹⁾)	Assembly Instance No.	Inputs								Outputs		
				Safety Input Data	Combined Safety Input Status	Individual Safety Input Status	Combined Safety Output Status	Individual Safety Output Status	Muting Lamp Status	Safety Output Readback	Individual Test Output Status	Safety Output Data	Standard Output Data	
•	•	Safety	203	•										
•	•	Safety - Combined Status - Muting Status	330	•	•		•			•				
•	•	Safety - Point Status - Muting Status	331	•		•		•		•				
•	•	Safety - Readback - Point Status - Muting Status	332	•		•		•		•	•			
•	•	Safety - Readback - Point Status - Muting Status - Test Output Status	333	•		•		•		•	•			
	•	Test	21											•
•		Safety	233										•	
•		Combined	350										•	•
	•	Output Readback/Test Output Status with General Status Assembly	342								•	•		

(1) Found in the Logix Designer application, I/O Module Properties, General tab.

Table 45 - 1791DS-IB8X0BV4 Modules

Safety Connection	Standard Connection	Configuration Software Setting (see Module Definition ⁽¹⁾)	Assembly Instance No.	Inputs								Outputs		
				Safety Input Data	Combined Safety Input Status	Individual Safety Input Status	Combined Safety Output Status	Individual Safety Output Status	Muting Lamp Status	Safety Output Readback	Individual Test Output Status	Safety Output Data	Standard Output Data	
•	•	Safety	204	•										
•	•	Safety - Combined Status - Muting	324	•	•		•			•				
•	•	Safety - Point Status - Muting	344	•		•		•		•				
•	•	Safety - Readback - Point Status - Muting	354	•		•		•		•	•			
•	•	Safety - Readback - Point Status - Muting - Test Output	374	•		•		•		•	•			
	•	Test	22											•
•		Safety	234										•	
•		Combined	2C4										•	•

(1) Found in the Logix Designer application, I/O Module Properties, General tab.

Table 46 - 1732DS-IB8 Modules

Safety Connection	Standard Connection	Configuration Software Setting (see Module Definition ⁽¹⁾)	Assembly Instance No.	Inputs							Outputs		
				Safety Input Data	Combined Safety Input Status	Individual Safety Input Status	Combined Safety Output Status	Individual Safety Output Status	Muting Lamp Status	Safety Output Readback	Individual Test Output Status	Safety Output Data	Standard Output Data
•	•	Safety	204	•									
•	•	Safety - Point Status - Muting Status	334	•		•		•	•				
•	•	Safety - Point Status - Muting - Test Output	364	•		•			•	•			
•	•	Safety - Combined Status - Muting	314	•	•		•		•				
•	•	Safety - Point Status	224	•		•							
	•	Test	22										•

(1) Found in the Logix Designer application, I/O Module Properties, General tab.

Table 47 - 1732DS-IB8X0BV4 Modules

Safety Connection	Standard Connection	Configuration Software Setting (see Module Definition ⁽¹⁾)	Assembly Instance No.	Inputs								Outputs		
				Safety Input Data	Combined Safety Input Status	Individual Safety Input Status	Combined Safety Output Status	Individual Safety Output Status	Muting Lamp Status	Safety Output Readback	Individual Test Output Status	Safety Output Data	Standard Output Data	
•	•	Safety	204	•										
		Safety - Combined Status - Muting	324	•	•		•			•				
•	•	Safety - Point Status - Muting	344	•		•		•		•				
•	•	Safety - Readback - Point Status - Muting	354	•		•		•		•	•			
•	•	Safety - Readback - Point Status - Muting - Test Output	374	•		•		•		•	•			
	•	Test	22											•
•		Safety	234										•	
•		Combined	2C4										•	•

(1) Found in the Logix Designer application, I/O Module Properties, General tab.

Table 48 - 1791DS-IB16 Modules

Safety Connection	Standard Connection	Configuration Software Setting (see Module Definition ⁽¹⁾)	Assembly Instance No.	Inputs							Outputs		
				Safety Input Data	Combined Safety Input Status	Individual Safety Input Status	Combined Safety Output Status	Individual Safety Output Status	Muting Lamp Status	Safety Output Readback	Individual Test Output Status	Safety Output Data	Standard Output Data
•	•	Safety	205	•									
•	•	Safety - Point Status - Muting	335	•		•			•				
•	•	Safety - Point Status - Muting - Test Output	365	•		•			•	•			
•	•	Safety - Combined Status - Muting	315	•	•				•				
•	•	Safety - Point Status	225	•		•							
•	•	Test	23										•
		None	C7										

(1) Found in the Logix Designer application, I/O Module Properties, General tab.

A

about catalog numbers 19
acetone 17
administrator, safety 13
architectures
 safety 19
assembly and reference data 148

B

before you begin 13
benzene 17
bus off 11

C

cables 45
catalog numbers 19
cleaning 17
colored stickers 46
configuration lock 26
configure always checkbox 126
configure the module 61, 115
connecting
 communication connectors 46
connection 11
controlling devices 38

D

data, reference 148
dialog
 Output Configuration 77
 Safety 71
 Test Output Configuration 76
DIN rail 17
directives 39

E

EC directives 17
electronic data sheet 11
EMC directives 41

F

ferrite core 42
firmware 13

H

help button 61

I

I/O configuration tree 62

installation 44
isolating transformer 16

L

legislation and standards 39
limit, connection reaction time 11
Logix Designer application 61

M

mean time between failure 11, 161
model types 19
mounting 17
MTBF
 See mean time between failure.

N

node address setting 46
noise 42

O

ODVA 11, 39
off-delay function 33
on-delay function 33
out-of-box condition 43
output configuration dialog 77

P

parameters
 general 165
 groups 165
 safety input 165
 test output 165
PFD
 See probability of failure on demand.
PFH
 See probability of failure per hour.
precautions for use 14
probability of failure on demand 11
probability of failure per hour 11
proof test 11
publications, related 10

R

reference data 148
related publications 10
replace units 38
rotary switches 46
RSLogix 5000 software
 version 19

RSNetWorx for DeviceNet software 11, 81
version 19

S

safety dialog 71

safety functions

safety input 26

safety output 36

safety network number 11, 63

self-diagnostics 26

SLogix 5000 software

version 19

SNN

See safety network number.

standards 39

Studio 5000 environment

version 19

Studio 5000 software 10

switches, rotary 46

T

thinner 17

torquing 17

transformer, isolating 16

tree, configuration 62

V

ventilation 17

Notes:

Rockwell Automation Support

Use these resources to access support information.

Technical Support Center	Find help with how-to videos, FAQs, chat, user forums, and product notification updates.	rok.auto/support
Knowledgebase	Access Knowledgebase articles.	rok.auto/knowledgebase
Local Technical Support Phone Numbers	Locate the telephone number for your country.	rok.auto/phonesupport
Literature Library	Find installation instructions, manuals, brochures, and technical data publications.	rok.auto/literature
Product Compatibility and Download Center (PCDC)	Download firmware, associated files (such as AOP, EDS, and DTM), and access product release notes.	rok.auto/pcdc

Documentation Feedback

Your comments help us serve your documentation needs better. If you have any suggestions on how to improve our content, complete the form at rok.auto/docfeedback.

Waste Electrical and Electronic Equipment (WEEE)



At the end of life, this equipment should be collected separately from any unsorted municipal waste.





Rockwell Automation maintains current product environmental compliance information on its website at rok.auto/pec.

Allen-Bradley, CompactBlock, expanding human possibility, Guard I/O, GuardLogix, Logix 5000, RSNetWorx, RSLogix, SmartGuard, Studio 5000, TechConnect, and Rockwell Automation are trademarks of Rockwell Automation, Inc.

EtherNet/IP is a trademark of ODVA, Inc.

Trademarks not belonging to Rockwell Automation are property of their respective companies.

Rockwell Otomasyon Ticaret A.Ş. Kar Plaza İş Merkezi E Blok Kat:6 34752, İçerenköy, İstanbul, Tel: +90 (216) 5698400 EEE Yönetmeliğine Uygundur

Connect with us.    

rockwellautomation.com — expanding **human possibility**[®]

AMERICAS: Rockwell Automation, 1201 South Second Street, Milwaukee, WI 53204-2496 USA, Tel: (1) 414.382.2000, Fax: (1) 414.382.4444

EUROPE/MIDDLE EAST/AFRICA: Rockwell Automation NV, Pegasus Park, De Kleetlaan 12a, 1831 Diegem, Belgium, Tel: (32) 2 663 0600, Fax: (32) 2 663 0640

ASIA PACIFIC: Rockwell Automation, Level 14, Core F, Cyberport 3, 100 Cyberport Road, Hong Kong, Tel: (852) 2887 4788, Fax: (852) 2508 1846